

HANDBOOK



PEUGEOT 308





On-line handbook

You can find your handbook on the PEUGEOT website, under "MyPeugeot".

This personal space offers advice and other useful information for the care and maintenance of your vehicle.

Referring to the handbook on-line also gives you access to the latest information available, easily identified by the bookmark, associated with this symbol:



Select:

- > The Vehicle documentation link in the home page (no registration is needed),
- > the language,
- > the vehicle, its body style,
- > the print edition of your handbook appropriate for the date of registration of your vehicle.

You have access to your handbook on line, together with the latest information, identified by the symbol:



If the "MyPeugeot" function is not available on the PEUGEOT public website for your country, you can find your handbook at the following address:

<http://public.servicebox.peugeot.com/ddb/>

Welcome

Within the model range, an item of equipment may be not available, an option or fitted as standard.

When an option, the customer has the choice of adding to the vehicle's equipment at extra cost when ordering and before the vehicle is produced.

Any equipment fitted after the vehicle leaves the production line becomes an aftermarket accessory.

The user instructions are provided by the manufacturer of the accessory, they do not appear in this edition of the guide.

Thank you for choosing a 308.

This handbook has been designed to enable you to make the most of your vehicle in all situations.

Key

Warning

This symbol marks warnings which it is essential to observe for your own safety, for the safety of others or to avoid any risk of damaging your vehicle.

Information

This symbol draws your attention to additional information for better use of your vehicle.



Protection of the environment

This symbol accompanies advice relating to protection of the environment.

Please note the following point:

The fitting of electrical equipment or accessories which are not recommended by PEUGEOT may result in a failure of your vehicle's electronic system. Please note this specific warning. It is advisable to contact a PEUGEOT dealer to be shown the recommended equipment and accessories.

Contents

<p>Visual search</p>	<p>2</p>	<p>Access</p>	<p>4</p>	<p>Driving</p>
		Remote control key	46	Starting-switching off the engine
		"Keyless Entry and Starting" with remote control	53	Manual parking brake
		"Keyless Entry and Starting" on your person	55	Electric parking brake
		Boot	58	Hill start assist
		Alarm	65	5-speed manual gearbox
		Electric windows	69	6-speed manual gearbox
<p>Eco-driving</p>	<p>3</p>	Panoramic sunroof	71	Gear shift indicator
		Fuel tank	72	Automatic gearbox
		Diesel misfuel prevention	73	Dynamic function
				Stop & Start
				Speed limiter
				Cruise control
				Active cruise control
				Display of inter-vehicle time
				Emergency collision alert system, emergency collision braking system
				Blind spot sensors
				Parking sensors
				Reversing camera
				Park Assist
<p>Monitoring</p>	<p>1</p>	<p>Comfort</p>	<p>3</p>	
Instrument panel	12	Steering wheel adjustment	75	
Indicator and warning lamps	13	Front seats	76	
Gauges and indicators	26	Rear seats (saloon)	81	
Adjustment buttons	30	Rear seats (SW)	82	
Trip computer	32	Interior fittings	84	
Touch screen	36	Front armrest	86	
Setting the date and time	42	Boot fittings (saloon)	90	
		Boot fittings (SW)	91	
		Heating and Ventilation	95	
		Heating	97	
		Manual air conditioning	97	
		Manual air conditioning (Touch screen)	99	
		Dual-zone digital air conditioning (Touch screen)	101	
		Front demist - defrost	106	
		Rear screen demist - defrost	107	

Visibility

5

Mirrors	170
Lighting	173
Daytime running lamps	177
Automatic illumination of headlamps	178
Headlamp adjustment	180
Wipers	181
Automatic rain sensitive wipers	183
Courtesy lamps	185
Interior mood lighting	186

Safety

6

Direction indicators	187
Hazard warning lamps	187
Emergency or assistance call	188
Horn	188
Tyre under-inflation detection	189
ESC system	193
Seat belts	196
Airbags	199
Child seats	204
Deactivating the passenger's front airbag	207
ISOFIX child seats	213
Child lock	220

Practical information

7

Temporary puncture repair kit	221
Changing a wheel	227
Snow chains	234
Changing a bulb	235
Changing a fuse	245
12 V battery	251
Energy economy mode	255
Changing a wiper blade	256
Towing the vehicle	257
Very cold climate screen	259
Towing a trailer	260
Fitting roof bars	262
Accessories	264

Checks

8

Bonnet	267
Petrol engine	268
Diesel engine	269
Running out of fuel (Diesel)	270
Additif AdBlue® additive and SCR system (Blue HDi Diesel)	271
Checking levels	280
Checks	283

Technical data

9

Engines	285
Weights	285
Dimensions	286
Identification markings	287

Audio equipment and telematics

Emergency or assistance	289
DENON equipment	291
Touch screen	293
PEUGEOT Connect Sound (RD5)	365

Exterior

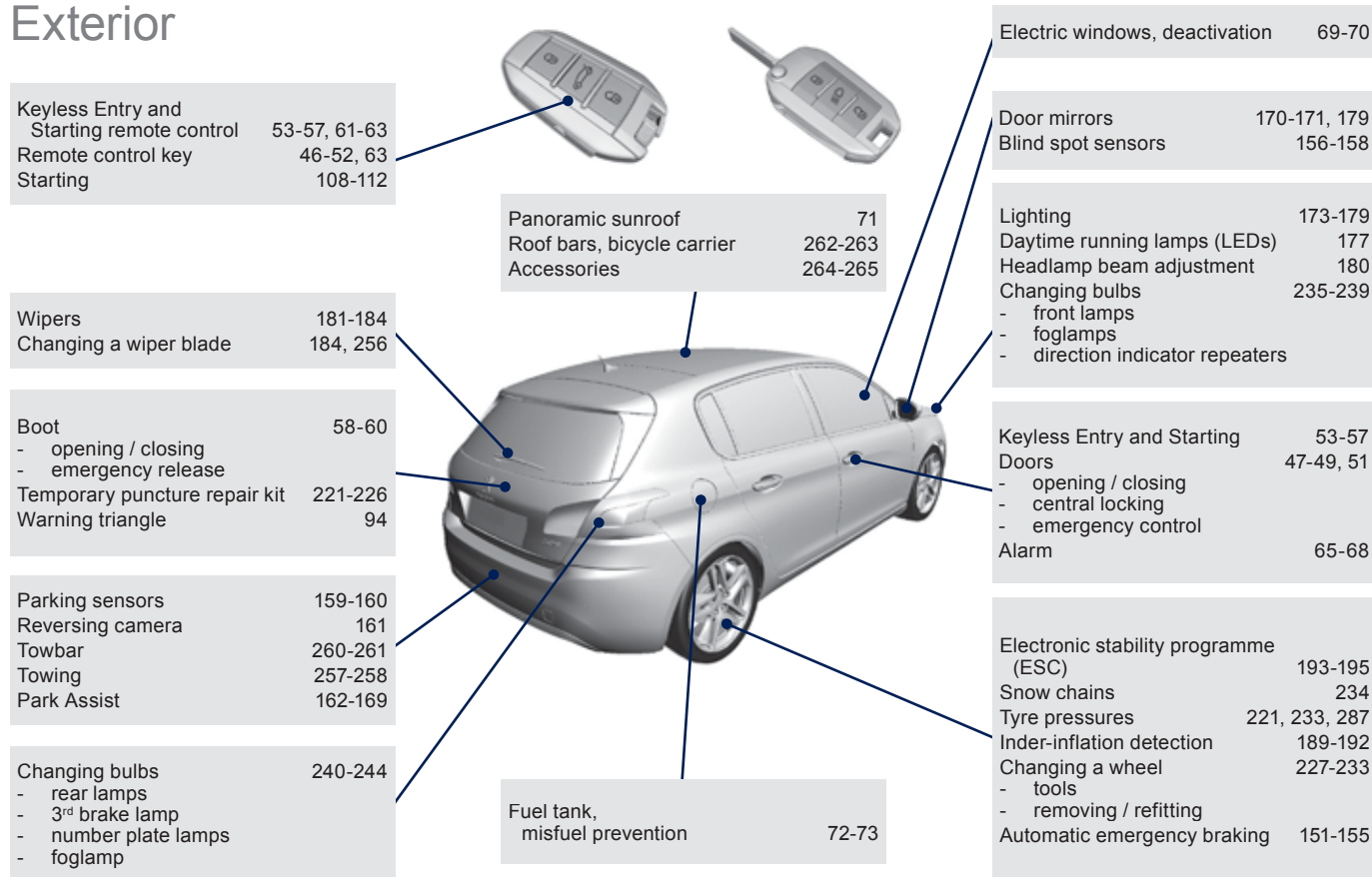

Interior

Saloon

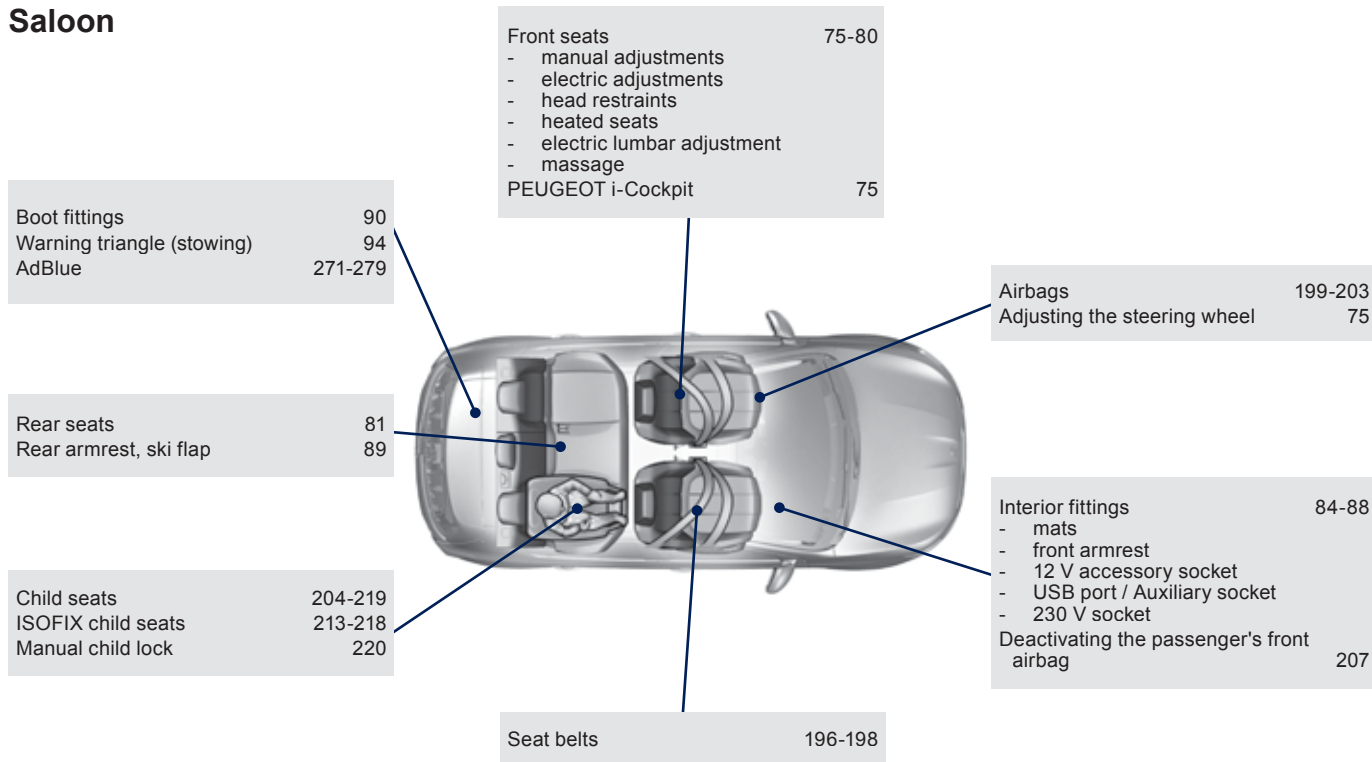

SW

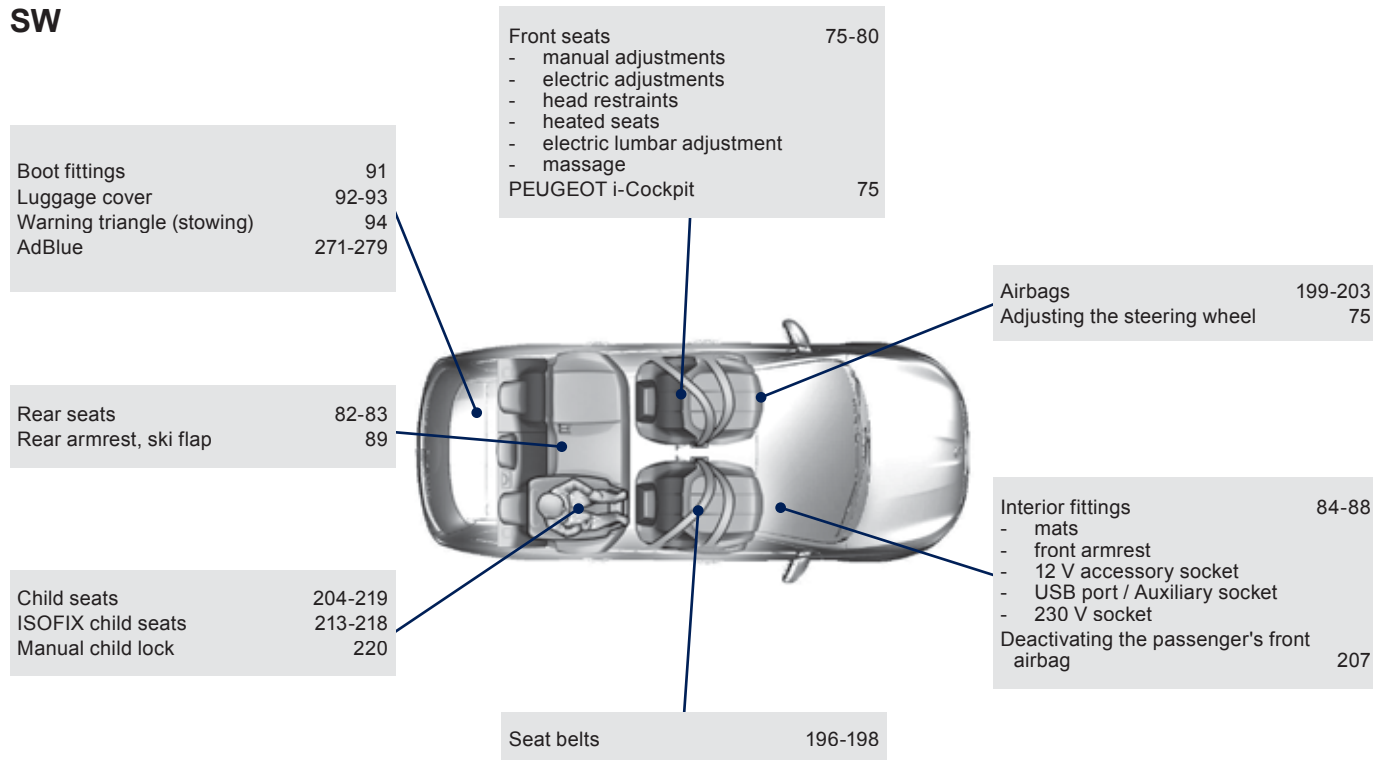

Instruments and controls

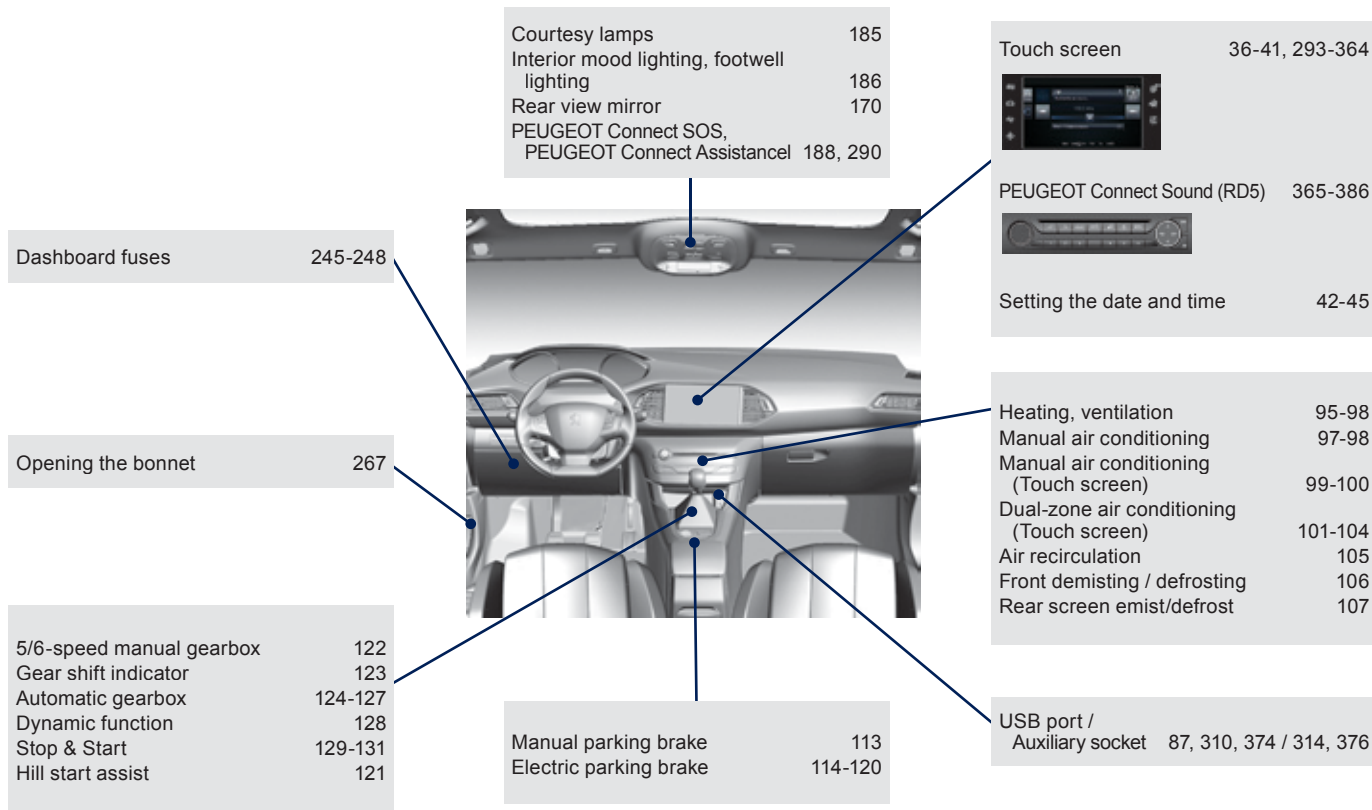

Instruments and controls (cont.)

Instrument panel	12-13
Warning lamps	13-25
Indicators	26-31
Gear shift indicator	123

Lighting	173-179
Direction indicators	187

Headlamp beam adjustment	180
--------------------------	-----

Stop & Start Alarm	129-131 65-68
--------------------	------------------

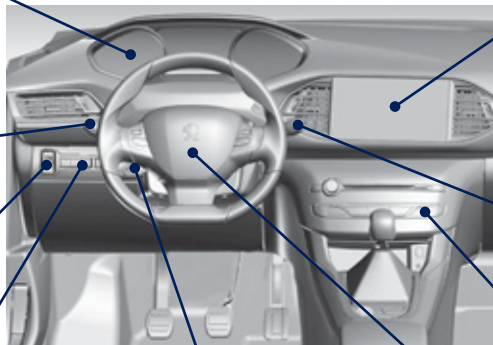

Trip computer	32-33, 35
Trip computer (Touch screen)	34, 35
Setting the date/time (Touch screen)	42
Setting the date/time (screens C, A, A without audio system)	43-45
Reversing camera	161
Display of inter vehicle time	147-150
Collision risk alert	151-153
Automatic emergency braking	154-155

Wipers	181-184
Trip computer	32-33, 35

Hazard warning lamps	187
Locking/unlocking from inside	64

Memorising speeds	132
Speed limiter	133-135
Cruise control	136-138
Active cruise control	139-146

Steering wheel adjustment	75
Horn	188

Maintenance - Technical data

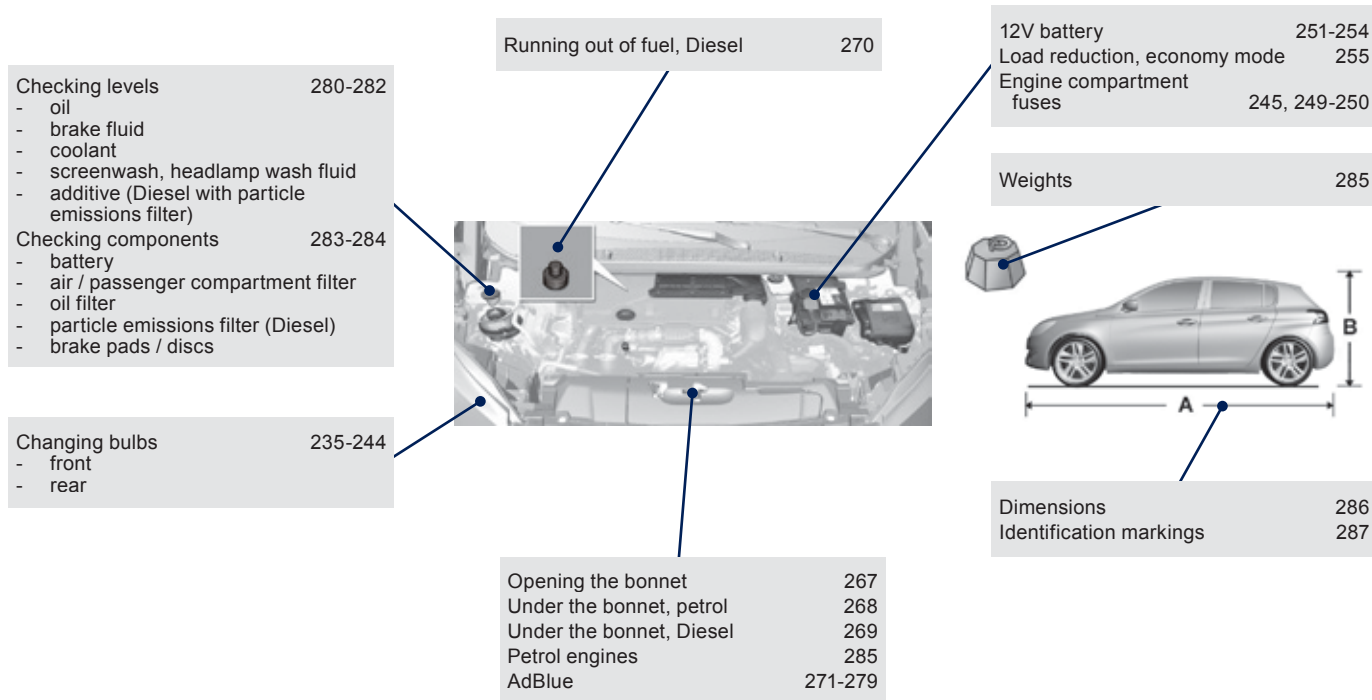

Eco-driving

Eco-driving is a range of everyday practices that allow the motorist to optimise their fuel consumption and CO₂ emissions.

Optimise the use of your gearbox

With a manual gearbox, move off gently and change up without waiting. During acceleration change up early.

With an automatic or electronic gearbox, give preference to automatic mode and avoid pressing the accelerator pedal heavily or suddenly.

The gear shift indicator invites you engage the most suitable gear: as soon as the indication is displayed in the instrument panel, follow it straight away.

For vehicles fitted with an electronic or automatic gearbox, this indicator appears only in manual mode.

Drive smoothly

Maintain a safe distance between vehicles, use engine braking rather than the brake pedal, and press the accelerator progressively. These practices contribute towards a reduction in fuel consumption and CO₂ emissions and also helps reduce the background traffic noise.

If your vehicle has cruise control, make use of the system at speeds above 25 mph (40 km/h) when the traffic is flowing well.

Control the use of your electrical equipment

Before moving off, if the passenger compartment is too warm, ventilate it by opening the windows and air vents before using the air conditioning. Above 30 mph (50 km/h), close the windows and leave the air vents open.

Remember to make use of equipment that can help keep the temperature in the passenger compartment down (sunroof and window blinds...).

Switch off the air conditioning, unless it has automatic regulation, as soon as the desired temperature is attained.

Switch off the demisting and defrosting controls, if not automatic. Switch off the heated seat as soon as possible.

Switch off the headlamps and front foglamps when the level of light does not require their use.

Avoid running the engine before moving off, particularly in winter; your vehicle will warm up much faster while driving.

As a passenger, if you avoid connecting your multimedia devices (film, music, video game...), you will contribute towards limiting the consumption of electrical energy, and so of fuel.

Disconnect your portable devices before leaving the vehicle.

Limit the causes of excess consumption

Spread loads throughout the vehicle; place the heaviest items in the bottom of the boot, as close as possible to the rear seats.
Limit the loads carried in the vehicle and reduce wind resistance (roof bars, roof rack, bicycle carrier, trailer...). Use a roof box in preference. Remove roof bars and roof racks after use.

At the end of winter, remove snow tyres and refit your summer tyres.

Observe the recommendations on maintenance

Check the tyre pressures regularly, when cold, referring to the label in the door aperture, driver's side.

Carry out this check in particular:

- before a long journey,
- at each change of season,
- after a long period out of use.

Don't forget the spare wheel and the tyres on any trailer or caravan.

Have your vehicle serviced regularly (engine oil, oil filter, air filter, passenger compartment filter...) and observe the schedule of operations recommended in the warranty and maintenance record.

When refuelling, do not continue after the third cut-off of the nozzle to avoid any overflow.

At the wheel of your new vehicle, it is only after the first 1 800 miles (3 000 kilometres) that you will see the fuel consumption settle down to a consistent average.

Instrument panel

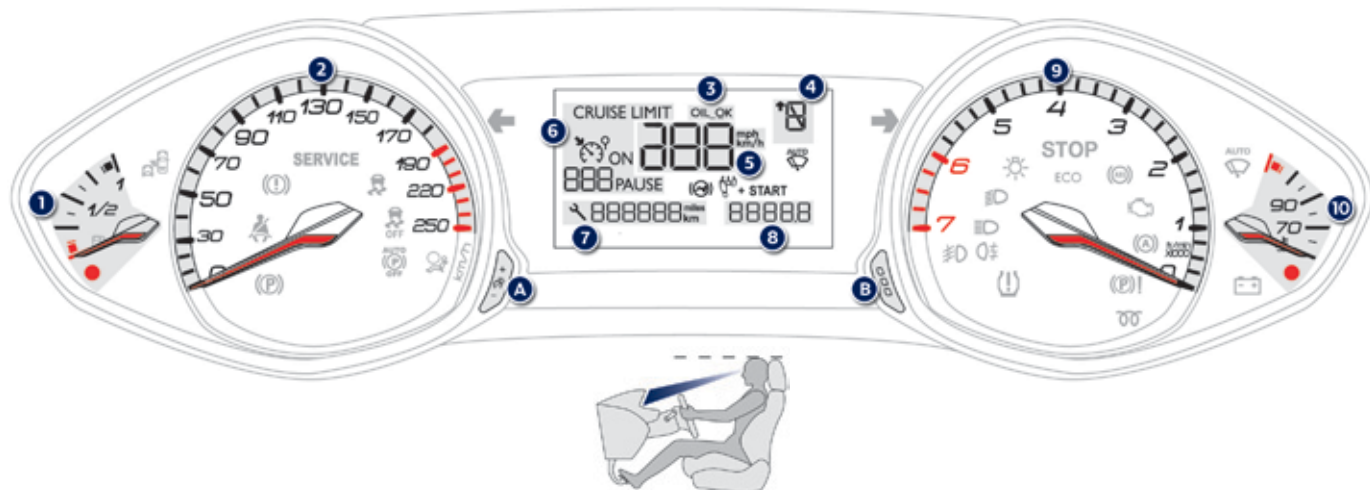

Dials and screens

1. Fuel gauge.
2. Analogue speedometer (mph or km/h).
3. Engine oil level indicator.
4. Gear shift indicator.
Gear with an automatic gearbox.
5. Digital speedometer (mph or km/h).
6. Cruise control or speed limiter settings.







7. Service indicator, then total distance recorder (miles or km).
These functions are displayed in turn when the ignition is switched on.
8. Trip distance recorder (miles or km).
9. Rev counter (x 1 000 rpm or tr/min),
graduation according to engine (petrol or Diesel).
10. Engine coolant temperature gauge.

Control buttons



- A. Main lighting dimmer.
- B. Reset the trip distance recorder.
Instantaneous information on:
 - servicing,
 - remaining driving range with the emissions additive.





Operation indicator lamps

If one of the following indicator lamps comes on in the instrument panel and/or instrument panel screen, this confirms that the corresponding system has come into operation.

Warning / indicator lamp		State	Cause	Action / Observations
	Left-hand direction indicator	flashing with buzzer.	The lighting stalk is pushed down.	
	Right-hand direction indicator	flashing with buzzer.	The lighting stalk is pushed up.	
	Sidelamps	fixed.	The lighting stalk is in the "Sidelamps" position.	
	Dipped beam headlamps	fixed.	The lighting stalk is in the "Dipped beam headlamps" position.	
	Main beam headlamps	fixed.	The lighting stalk is pulled towards you.	Pull the stalk to return to dipped beam headlamps.
	Front foglamps	fixed.	The front foglamps are switched on.	Turn the ring on the stalk rearwards twice to switch off the front foglamps.



 For more information on the lighting controls, refer to the corresponding section.

Warning / indicator lamp	State	Cause	Action / Observations
	Rear foglamps	fixed.	The rear foglamps are switched on. Turn the ring on the stalk rearwards to switch off the rear foglamps.
	Diesel engine pre-heating	fixed.	The ignition switch is at the 2 nd position (ignition on) or the START/STOP button has been pressed. Wait until the warning lamp goes off before starting. Once it goes off, starting is immediate, on condition that: <ul style="list-style-type: none"> - the clutch pedal is pressed fully down with a manual gearbox, - pressure is maintained on the brake pedal with an automatic gearbox. The period of illumination of the warning lamp is determined by the ambient conditions (up to about thirty seconds in extreme conditions). If the engine does not start, switch the ignition off and then on, wait until the warning lamp goes off again, then start the engine.
	Parking brake	fixed.	The parking brake is applied or not fully released. To switch off the warning lamp: with your foot on the brake pedal, release the parking brake. If your vehicle has an electric parking brake: with your foot on the brake pedal, push the brake control lever. Observe the safety recommendations. For more information on the parking brake, refer to the corresponding section.

Warning / indicator lamp		State	Cause	Action / Observations
 AUTO wiping	fixed.	The wiper control is pushed downwards.	Automatic front wiping is activated. To deactivate automatic wiping, operate the control stalk downwards or put the stalk into another position.	
 Passenger airbag system	fixed.	The control switch, located at the passenger's end of the dashboard, is in the "ON" position. The passenger's front airbag is activated. In this case, do not install a rearward facing child seat on the front passenger seat.	Turn the control switch to the "OFF" position to deactivate the front passenger's airbag. In this case you can install a rearward facing child seat.	
 Stop & Start	fixed.	When the vehicle stops (red lights, traffic jams, ...) the Stop & Start system has put the engine into STOP mode.	The warning lamp goes off and the engine restarts automatically in START mode, as soon as you want to move off.	
	flashes for a few seconds, then goes off.	STOP mode is temporarily unavailable. or START mode is invoked automatically.	For more information on special cases with STOP mode and START mode, refer to the "Stop & Start" section.	
 Blind spot sensors	fixed.	The blind spot monitoring function has been activated.	For more information, refer to the corresponding section.	

Deactivation indicator lamps

If one of the following indicator lamps comes on, this confirms that the corresponding system has been switched off intentionally. This is may be accompanied by an audible signal and the display of a message.

Warning / indicator lamp	State	Cause	Action / Observations
 Passenger's front airbag	fixed in the seat belt and front passenger's airbag warning lamps display.	<p>The control switch, located on the passenger's end of the dashboard, is set to the "OFF" position.</p> <p>The passenger's front airbag is deactivated.</p> <p>You can install a rearward facing child seat on the front passenger seat.</p>	To activate the front passenger's airbag, set the switch to the "ON" position; in this case, it is not possible to fit a child seat in the rearward facing position on this seat.
 Dynamic stability control (DSC/ASR)	fixed.	<p>The button is pressed and the indicator lamp comes on.</p> <p>The DSC/ASR is deactivated.</p> <p>DSC: dynamic stability control.</p> <p>ASR: anti-slip regulation.</p>	<p>Press the button to activate the DSC/ASR. Its indicator lamp goes off.</p> <p>The DSC/ASR system is activated automatically when the vehicle is started.</p> <p>If deactivated, the system is reactivated automatically from around 30 mph (50 km/h).</p> <p>For more information on DSC/ASR, refer to the corresponding section.</p>

Warning lamps



When the engine is running or the vehicle is being driven, illumination of one of the following warning lamps indicates a fault which requires action on the part of the driver.





Any fault resulting in the illumination of a warning lamp must be investigated further using the associated message.



If you encounter any problems, contact a PEUGEOT dealer or a qualified workshop.



Warning / indicator lamp		State	Cause	Action / Observations
STOP	STOP	fixed, associated with another warning lamp, accompanied by an audible signal and a message.	Illumination of this warning lamp is related to a serious fault detected with the braking or power steering systems, the electrical system, or with engine lubrication or cooling or a puncture.	Stop as soon as it is safe to do so as the engine may cut out. Park, switch off the ignition and call a PEUGEOT dealer or a qualified workshop.

Warning / indicator lamp		State	Cause	Action / Observations
SERVICE	Service	on temporarily.	A minor fault has occurred for which there is no specific warning lamp.	<p>Identify the fault by means of the associated message, such as:</p> <ul style="list-style-type: none"> - low engine oil level, - low screenwash/headlamp wash fluid level, - discharged remote control battery, - low tyre pressures, - saturation of the particle emission filter (PEF) on Diesel vehicles. <p>For more information on the PEF, refer to the "Checks - particle emissions filter" section.</p> <p>For any other faults, contact a PEUGEOT dealer or a qualified workshop.</p>
		fixed.	A major fault has occurred for which there is no specific warning lamp.	Identify the fault by reading the message and contact a PEUGEOT dealer or a qualified workshop.





Warning / indicator lamp		State	Cause	Action / Observations
	Electric parking brake	flashing.	The electric parking brake is not applied automatically. The application/release is faulty.	You must stop as soon as it is safe to do so. Park on flat level ground, engage a gear (or place the lever in position P for an automatic gearbox), switch off the ignition and contact a PEUGEOT dealer or a qualified workshop.
	Electric parking brake fault	fixed.	The electric parking brake has a fault.	Contact a PEUGEOT dealer or a qualified workshop without delay. For more information on the electric parking brake, refer to the corresponding section.
	Deactivation of the automatic functions of the electric parking brake	fixed.	The "automatic application" (on switching off the engine) and "automatic release" functions are deactivated or faulty. In the event of a fault, illumination of this warning lamp is accompanied by a message.	To reactivate the automatic functions, refer to the "Electric parking brake" section. Contact a PEUGEOT dealer or a qualified workshop if automatic application / release is not possible. The parking brake can be released manually. For more information on the electric parking brake, refer to the corresponding section.



Warning / indicator lamp	State	Cause	Action / Observations	
	Braking	fixed.	The braking system fluid level has dropped significantly.	You must stop as soon as it is safe to do so. Top up with brake fluid listed by PEUGEOT. If the problem persists, have the system checked by a PEUGEOT dealer or a qualified workshop.
+ 		fixed, associated with the ABS warning lamp.	The electronic brake force distribution (EBFD) system has a fault.	You must stop as soon as it is safe to do so. Have it checked by a PEUGEOT dealer or a qualified workshop.
	Anti-lock Braking System (ABS)	fixed.	The anti-lock braking system has a fault.	The vehicle retains conventional braking. Drive carefully at reduced speed and contact a PEUGEOT dealer or a qualified workshop without delay.
	Dynamic stability control (DSC/ASR)	flashing.	The DSC/ASR regulation is operating.	The system optimises traction and improves the directional stability of the vehicle in the event of loss of grip or trajectory.
		fixed.	The DSC/ASR system has a fault.	Have it checked by a PEUGEOT dealer or a qualified workshop.

Warning / indicator lamp		State	Cause	Action / Observations
	Engine autodiagnosis system	flashing.	The engine management system has a fault.	Risk of destruction of the catalytic converter. Have it checked by a PEUGEOT dealer or a qualified workshop.
		fixed.	The emission control system has a fault.	The warning lamp should go off when the engine is started. If it does not go off, contact a PEUGEOT dealer or qualified workshop without delay.
	Emergency Collision Braking System	flashing.	The Emergency Collision Braking System is active.	The system brakes briefly so as to reduce the speed of collision with the vehicle ahead.
		fixed, accompanied by a message and an audible signal	The Emergency Collision Braking System has a fault.	Have it checked by a PEUGEOT dealer or a qualified workshop.
		fixed.	The Emergency Collision Braking System has been deactivated (via the menu).	
	Low fuel level	fixed, with the needle in the red zone.	When it first comes on there remains less than 10 litres of fuel in the tank.	You must refuel as soon as possible to avoid running out of fuel. This warning lamp will come on every time the ignition is switched on, until a sufficient addition of fuel is made. Fuel tank capacity: approximately 53 litres or 45 litres depending on version. Never continue to drive until you run out of fuel as this could damage the emission control and injection systems.

Warning / indicator lamp		State	Cause	Action / Observations
	Seat belt(s) not fastened / unfastened	fixed or flashing accompanied by an audible signal.	A seat belt has not been fastened or has been unfastened.	Pull the strap then insert the tongue in the buckle.
	Airbags	on temporarily.	This lamp comes on for a few seconds when you turn on the ignition, then goes off.	This lamp should go off when the engine is started. If it does not go off, contact a PEUGEOT dealer or a qualified workshop.
		fixed.	One of the airbag or seat belt pretensioner systems has a fault.	Have it checked by a PEUGEOT dealer or a qualified workshop.
	Battery charge*	fixed.	The battery charging circuit has a fault (dirty or loose terminals, slack or cut alternator belt, ...).	The warning lamp should go off when the engine is started. If it does not go off, contact a PEUGEOT dealer or a qualified workshop.

* According to destination country.

Warning / indicator lamp		State	Cause	Action / Observations
	Engine oil pressure	fixed.	There is a fault with the engine lubrication system.	You must stop as soon it is safe to do so. Park, switch off the ignition and contact a PEUGEOT dealer or a qualified workshop.
	Deflated tyre	fixed.	The pressure in one or more tyres is too low.	Check the pressures of the tyres as soon as possible. This check should preferably carried out with the tyres cold.
		flashing then fixed.	The under-inflation detection system has a fault.	Have it checked by a PEUGEOT dealer or a qualified workshop. For more information on under-inflation detection, refer to the corresponding section.
	Foot on the brake pedal	fixed.	The brake pedal must be pressed.	With an automatic gearbox, press the brake pedal, engine running, before releasing the parking brake, to unlock the lever and come out of position P . If you wish to release the parking brake without pressing the brake pedal, this warning lamp will remain on.
	Foot on the clutch	fixed.	In the STOP mode of Stop & Start, changing to START mode is refused because the clutch pedal is not fully down.	You must declutch fully to allow the change to engine START mode.

Warning or indicator lamp in the instrument panel	State	Cause	Action / Observations
	Door(s) open	A door or the boot is still open.	Close the door or boot.
	fixed, associated with a message identifying the door, if the speed is below 6 mph (10 km/h).	fixed, associated with a message identifying the door, and accompanied by an audible signal if the speed is above 6 mph (10 km/h).	
	AdBlue® fuel additive range	on temporarily. The remaining range for the AdBlue® fuel additive is less than 1500 miles (2400 km). It comes on for a few seconds then goes off when you switch on the ignition.	It is recommended that you refill the AdBlue® fuel additive tank. Refer to the corresponding section.
		fixed, accompanied by an audible signal and a message indicating the remaining distance that can be travelled.	The remaining range for the additive is between 1500 and 375 miles (2400 and 600 km). Refill the AdBlue® tank. Refer to the corresponding section.
		flashing, associated with the Service warning lamp, accompanied by an audible signal and a message.	The remaining range for the additive is less than 375 miles (600 km). You must top up the AdBlue® tank (at least 3.8 litres) to avoid a breakdown. Until sufficient AdBlue® has been added, this warning lamp comes on every time the ignition is switched on, accompanied by an audible signal and a message.

Gauges and indicators

Coolant temperature gauge



With the engine running, when the needle is:

- in zone **A**, the temperature is correct,
- in zone **B**, the temperature is too high; the maximum temperature and the central **STOP** warning lamps come on, accompanied by an audible signal and a warning message in the screen.

You MUST stop as soon as it is safe to do so.

Wait a few minutes before switching off the engine.

Contact a PEUGEOT dealer or a qualified workshop.

After driving for a few minutes, the temperature and pressure in the cooling system increase.

To top up the level:

- ☞ wait for the engine to cool,
- ☞ unscrew the cap slightly to allow the pressure to drop,
- ☞ when the pressure has dropped, remove the cap,
- ☞ top up the level to the "MAX" mark.

! Be aware of the risk of burns when topping up the cooling system. Do not fill above the maximum level (indicated on the header tank).

Service indicator

This is a check against the planned servicing intervals in the manufacturer's servicing schedule.

It is calculated from the last service indicator reset according to the number of miles travelled and the time elapsed since the last service.

i For Blue HDi Diesel versions only (depending on country of sale), the level of deterioration of the engine oil is also taken into account.



More than 1 800 miles (3 000 km) remain before the next service is due

When the ignition is switched on, no service information appears in the screen.

Between 600 miles (1 000 km) and 1 800 miles (3 000 km) remain before the next service is due

For 5 seconds after the ignition is switched on, the spanner symbolising the service operations comes on. The distance recorder display line indicates the distance remaining before the next service is due.

Example: 1 700 miles (2 800 km) remain before the next service is due.

For 5 seconds after the ignition is switched on, the screen indicates:



5 seconds after the ignition is switched on, **the spanner goes off**; the distance recorder resumes its normal operation. The screen then indicates the total and trip distances.



Less than 600 miles (1 000 km) remain before the next service is due

Example: 560 miles (900 km) remain before the next service is due.

For 5 seconds after the ignition is switched on, the screen indicates:



5 seconds after the ignition is switched on, the distance recorder resumes its normal operation. **The spanner remains on** to indicate that a service must be carried out soon.



Service overdue

For 5 seconds after the ignition is switched on, **the spanner flashes** to indicate that the service must be carried out as soon as possible.

Example: the service is overdue by 186 miles (300 km).

For 5 seconds after the ignition is switched on, the screen indicates:



5 seconds after the ignition is switched on, the distance recorder resumes its normal operation. **The spanner remains on.**

With Blue HDi Diesel versions the **Service** warning lamp may come on as soon as the ignition is switched on.

i The spanner may also come on if you have exceeded the period since the last service, as indicated in the maintenance and warranty guide. With Blue HDi Diesel versions, the spanner can also come on in advance of the service interval, according to the level of deterioration of the engine oil, which depends on the driving conditions in which the vehicle is used.

Service indicator zero reset



After each service, the service indicator must be reset to zero.

If you have carried out the service on your vehicle yourself:

- ☞ switch off the ignition,
- ☞ press and hold the trip distance recorder zero reset button,
- ☞ switch on the ignition; the distance recorder display begins a countdown,
- ☞ when the display indicates "**=0**", release the button; the spanner disappears.

i Following this operation, if you wish to disconnect the battery, lock the vehicle and wait at least five minutes for the zero reset to be registered.

Retrieving the service information

You can access the service information at any time.

- ☞ Press the trip distance recorder zero reset button.

The service information is displayed for a few seconds, then disappears.

Engine oil level indicator

On versions fitted with an electric oil gauge, information on the oil level is displayed in the instrument panel for a few seconds when the ignition is switched on, at the same time as the service information.

- The level read will only be correct if the vehicle is on level ground and the engine has been off for more than 30 minutes.

OIL OK

Oil level correct

This is indicated by a message in the instrument panel.

OIL

Oil level incorrect

This is indicated by a message in the instrument panel.

If the low oil level is confirmed by a check using the dipstick, the level must be topped up to avoid damage to the engine.

OIL _ _

Oil level indicator fault

This is indicated by a message in the instrument panel. Contact a PEUGEOT dealer or a qualified workshop.

Dipstick

- Refer to the "Checks" section to locate the dipstick and the oil filler cap on your engine.



There are 2 marks on the dipstick:

- **A** = max; never exceed this level,
- **B** = min; top up the level via the oil filler, using the grade of oil suited to your engine.

Distance recorders

The total and trip distances are displayed for thirty seconds when the ignition is switched off, when the driver's door is opened and when the vehicle is locked or unlocked.

i To conform to legislation in the country you are crossing, change the units of distance (miles or km) via the configuration menu.

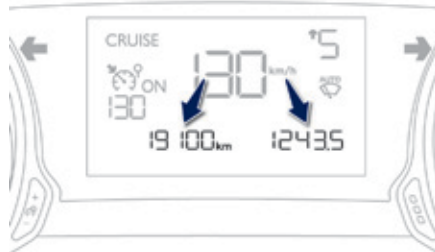

Total distance recorder

System which measures the total distance travelled by the vehicle since its first registration.

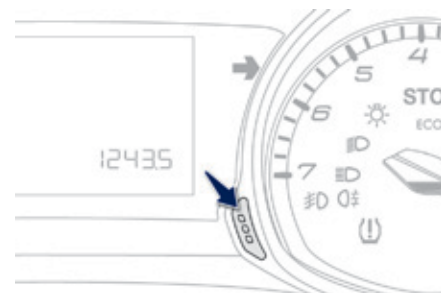

Trip distance recorder

System which measures a distance travelled during a day or other period since it was reset to zero by the driver.

☞ With the ignition on, press the button until zeros appear.

Lighting dimmer control

System for the manual adjustment of the brightness of the instrument panel and touch screen to suit the ambient light level.

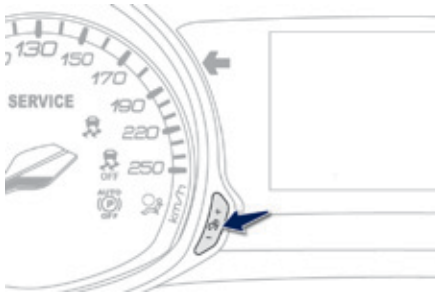

Instrument panel

With the exterior lighting on, press this button to adjust the brightness of the dashboard lighting, the touch screen and the mood lighting. As soon as the lighting reaches the required level of brightness, release the button.

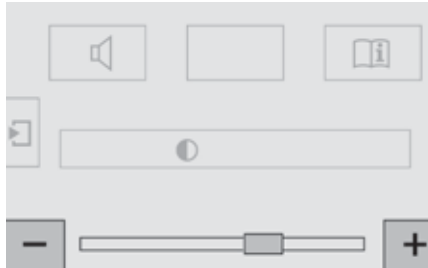

Touch screen

- ☞ Press on the **"Configuration"** menu.
- ☞ Adjust the brightness (only on the touch screen) by pressing on the **"+"** or **"-"** buttons.

Trip computer

System that gives you information on the current journey (range, fuel consumption...).

Depending on version

Instrument panel screen

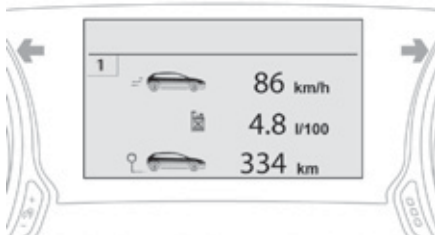

Information display



☞ Press the button on the end of the **wiper control stalk** to display the various tabs in succession.

- The current information tab with:
 - the range,
 - the current fuel consumption,
 - the Stop & Start time counter.

1

- Trip "1" with:
 - the average speed,
 - the average fuel consumption,
 - the distance travelled, for the first trip.

2

- Trip "2" with:
 - the average speed,
 - the average fuel consumption,
 - the distance travelled, for the second trip.

Trip reset

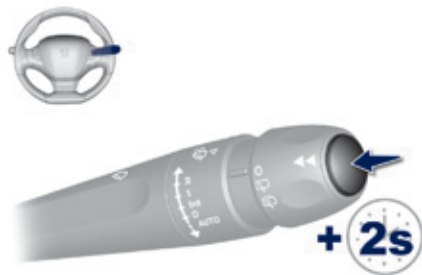

- ☞ When the trip required is displayed, press the control for more than two seconds or use the left hand thumb wheel of the steering mounted controls.

Trips "1" and "2" are independent but their use is identical.

For example, trip "1" can be used for daily figures, and trip "2" for monthly figures.

Trip computer

Touch screen

System that gives you information on the current journey (range, fuel consumption...).

The information is accessible in the "**Driving assistance**" menu.

Information display in the touch screen



Permanent display:

- ☞ Select the "**Driving assistance**" menu. The trip computer information is displayed in the primary page of the menu.
- ☞ Press one of the buttons to display the desired tab.

Temporary display in a new window:

- ☞ Press the end of the wiper control stalk for access to the information and display the different tabs.



The current instantaneous fuel consumption tab with:

- the range,
- the current fuel consumption,
- the Stop & Start time counter.



The trip "1" tab with:

- the distance travelled.
- the average fuel consumption,
- the average speed, for the first trip.



The trip "2" tab with:

- the distance travelled.
- the average fuel consumption,
- the average speed, for the second trip.

Trip reset

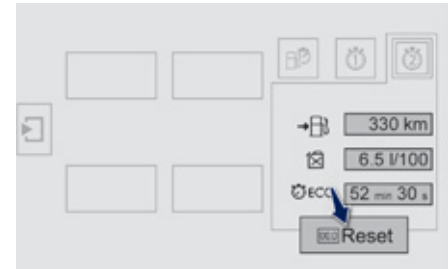

- ☞ When the desired trip is displayed, press the reset button or on the end of the wiper control stalk.

Trips "1" and "2" are independent but their use is identical.

For example, trip "1" can be used for daily figures, and trip "2" for monthly figures.

Trip computer, a few definitions



Range

(miles or km)

The distance which can still be travelled with the fuel remaining in the tank (related to the average fuel consumption over the last few miles (kilometres) travelled).



This value may vary following a change in the style of driving or the relief, resulting in a significant change in the current fuel consumption.

When the range falls below 20 miles (30 km), dashes are displayed. After filling with at least 5 litres of fuel, the range is recalculated and is displayed when it exceeds 60 miles (100 km).



If dashes are displayed continuously while driving in place of the digits, contact a PEUGEOT dealer or a qualified workshop.



Current fuel consumption

(mpg or l/100 km or km/l)

Calculated over the last few seconds.



This function is only displayed from 20 mph (30 km/h).



Average fuel consumption

(mpg or l/100 km or km/l)

Calculated since the last trip computer reset.



Average speed

(mph or km/h)

Calculated since the last trip computer reset.



Distance travelled

(miles or km)

Calculated since the last trip computer reset.



Stop & Start time counter

(minutes / seconds or hours / minutes)

If your vehicle is fitted with Stop & Start, a time counter calculates the time spent in STOP mode during a journey.

It resets to zero every time the ignition is switched on.

Touch screen

It gives access to:

- the heating/air conditioning controls,
- menus for adjusting settings for vehicle functions and systems,
- audio and display configuration menus,
- audio system and telephone controls and the display of associated information.

And, depending on equipment, it allows:

- the display of alert messages and the visual parking sensors information,
- access to the controls for the navigation system and Internet services, and the display of associated information.

! For reasons of safety, the driver should only carry out operations that require close attention, with the vehicle stationary.

Some functions are not accessible when driving.

General operation

Recommendations

It is necessary to press firmly, particularly for "flick" gestures (scrolling through lists, moving the map...).

A light wipe is not enough.

The screen does not recognise pressing with more than one finger.

This technology allows use at all temperatures and when wearing gloves.

Do not use pointed objects on the touch screen.

Do not touch the touch screen with wet hands.

Uses a soft clean cloth to clean the touch screen.

State of indicator lamps

Some buttons contain an indicator lamp that gives the state of the corresponding function.
Green indicator: you have switched on the corresponding function.

Orange indicator: you have switched off the corresponding function.

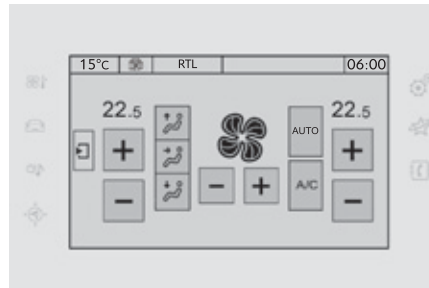

Principles

Use the buttons on either side of the touch screen for access to the menus, then press the virtual buttons in the touch screen.

Each menu is displayed over one or two pages (primary page and secondary page).



Use this button to go to the secondary page.



Use this button to return to the primary page.



After a few moments with no action on the secondary page, the primary page is displayed automatically.



Use this button for access to additional information and to the settings for certain functions.



Use this button to confirm.



Use this button to quit.

Touch screen menus



Air conditioning.

Allows adjustment of the various settings for temperature, air flow... See the sections on "Heating", "Manual air conditioning" and "Digital air conditioning".



Driving assistance.

Allows certain functions to be switched on and off and their settings adjusted.



Media.

See the "Audio equipment and telematics" section.



Navigation.

Depending on trim level, navigation can be not available, an option or standard. See the "Audio equipment and telematics" section.



Configuration.

Allows configuration of the display and the system.



Connected services.

These services can be not available, an option or standard. See the "Audio equipment and telematics" section.



Telephone.

See the "Audio equipment and telematics" section.





1. Volume / mute.
See the "Audio equipment and telematics" section.



"Driving assistance" menu

The systems with settings that can be adjusted are detailed in the table below.







Button	Corresponding function	Comments
A circular icon representing a speedometer, with a needle and a scale.	Speed settings	Memorisation of speeds for use with the speed limiter or cruise control.
A circular icon with an exclamation mark inside, representing a warning for under-inflation.	Under-inflation initialisation	Reinitialisation of the under-inflation system.
An icon showing a car with two rectangular sensors on its sides, representing blind spot sensors.	Blind spot sensors	Activation of the function.







Button	Corresponding function	Comments
	Vehicle settings	<p>Access to other functions with settings that can be adjusted. The functions are grouped together under three tabs:</p> <ul style="list-style-type: none"> - "Driving assistance" <ul style="list-style-type: none"> - "[Automatic rear wiper in reverse]" (Activation of rear wiper coupled to reverse gear; see the "[Visibility]" section) - "[Collision risk alert]" (Activation of the collision risk alert system; see the "[Driving] section") - "[Lighting]" <ul style="list-style-type: none"> - "[Guide-me-home lighting]" (Automatic guide me home lighting; see the "[Visibility]" section), - "[Welcome lighting]" (Exterior welcome lighting; see the "[Visibility]" section), - "[Mood lighting]" (Interior mood lighting; see the "[Visibility]" section). - "Vehicle access" <ul style="list-style-type: none"> - "[Driver plip action]" (Selective unlocking of the driver's door; see the "[Access]" section). - "[Unlocking boot]" (Selective unlocking of the boot; see the "[Access]" section). <p>Select or deselect the tabs at the bottom of the screen to display the functions required.</p>
CHECK	Diagnostic	List of current alerts.
	Parking sensors	Deactivation of the function.
	Inter-vehicle time	Activation of the function.



"Configuration" menu

The functions available through this menu are detailed in the table below.

Button	Corresponding function	Comments
	Audio settings	Adjustment of volume, balance...
	Color schemes	Choice of color scheme.
	Interactive help	Access to the interactive user guide.
	Turn off screen	
 	Brightness	

Button	Corresponding function	Comments
	System Settings	Choice of units: - temperature (°Celsius or °Fahrenheit) - distance and fuel consumption (l/100 km, mpg or km/l).
	Time/Date	Setting the date and time.
	Languages	Choice of language used: French, English, Italian, Spanish, German, Dutch, Portuguese, Polish, Turkish, Russian.
	Screen settings	Adjustment of the display settings (scrolling of text, animations...).
	Calculator	
	Calendar	

Setting the date and time

Touch screen

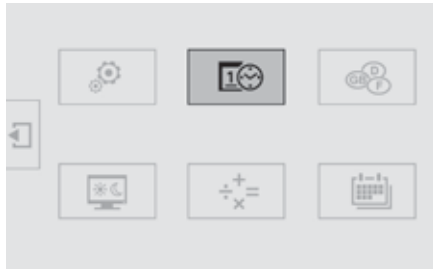

☞ Select the **"Configuration"** menu.



☞ From the secondary page, select **"Time/Date"**.

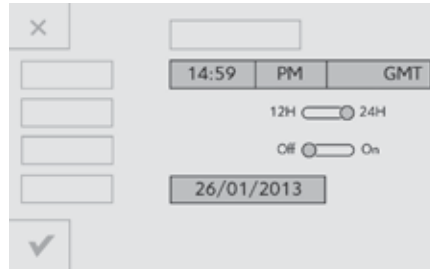

☞ Select **"Adjust time"** or **"Adjust date"** and modify the settings using the number pad, then confirm.



☞ Press **"Confirm"** to quit.

Screen C



- ☞ Press the **MENU** button for access to the **main menu**.

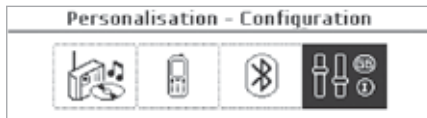

- ☞ Press the "◀" or "▶" button to select the **Personalisation-configuration** menu, then confirm by pressing the **"OK"** button.



- ☞ Press the "▲" or "▼" button to select the **Display configuration** menu then confirm by pressing the the **"OK"** button.
- ☞ Press the "▲" or "▼" and "◀" or "▶" buttons to set the date and time, then confirm by pressing the **"OK"** button.

i For more information on the **Multimedia** menu, refer to the "Audio equipment and telematics" section.

Screen A



- ☞ Press the **"MENU"** button to gain access to the **main menu**, then press the **"▲"** or **"▼"** buttons to go to the **Display settings** menu.
- ☞ Press the **"OK"** button to select the menu required.

You have access to the following settings:

- year,
- month,
- day,
- hour,
- minutes,
- 12 or 24 hour mode.



- ☞ Once you have selected a setting, press the **"◀"** or **"▶"** buttons to change its value.



- ☞ Press the **"▲"** or **"▼"** buttons to switch respectively to the previous or next setting.
- ☞ Press the **"OK"** button to register the change and return to the normal display or press the **"⏏"** button to cancel.

Screen A (without audio system)



- ☞ Once you have selected a setting using the "▲" or "▼" buttons, press the **"OK"** button to change its value.
- ☞ Wait for approximately ten seconds without any action to allow the change to be registered or press the **"ESC"** button to cancel.

The screen then returns to the normal display.

Remote control key

System which permits central unlocking or locking of the vehicle using the lock barrel or from a distance. It is also used to locate and start the vehicle, as well as providing protection against theft.



Unfolding the key

☞ First press this button to unfold the key.



Folding the key

☞ First press this button to fold the key.

! If you do not press the button when folding the key, there is a risk of damage to the mechanism.

Complete unlocking



Using the key

- ☞ Turn the key to the front of the vehicle to unlock the vehicle.

If your vehicle has an alarm, this is not deactivated. Opening a door will trigger the alarm, which can then be stopped by switching the ignition on.

Using the remote control



- ☞ Press the open padlock to unlock the vehicle.

i Unlocking is confirmed by rapid flashing of the direction indicators for approximately two seconds. According to version, the door mirrors unfold at the same time.

Selective unlocking

Complete unlocking is activated by default. This is set in the "**Driving assistance**" menu, then "**Vehicle settings**" and "**Vehicle access**".



Use this button for access to additional information.

Using the remote control



- ☞ To unlock the driver's door only press the open padlock once.

- ☞ To unlock the other doors and the boot, press the open padlock again.

i Unlocking is confirmed by rapid flashing of the direction indicators for approximately two seconds. According to version, the door mirrors unfold at the same time as the first unlocking action.

Normal locking



Using the key

☞ Turn the key towards the rear of the vehicle to lock the vehicle completely.

If your vehicle has an alarm, this will not be activated.

Using the remote control



☞ Press the closed padlock to lock the vehicle completely.

Maintaining the locking action (key or remote control) automatically closes the windows.

i Locking is confirmed by fixed lighting of the direction indicators for approximately two seconds. According to version, the door mirrors fold at the same time.

! Driving with the doors locked may render access for the emergency services difficult in an emergency. As a safety measure (children on board), never leave the vehicle without taking your key, even for a short period.



When a door or the boot is not fully closed, engine running or vehicle moving (speed above 6 mph (10 km/h)), a message appears for a few seconds.

i If one of the doors or the boot is still open or if an electronic key has been left inside the vehicle, the central locking does not take place. When the vehicle is locked, if it is unlocked inadvertently, it will relock automatically after about thirty seconds unless a door is opened.

And if your vehicle has an alarm, this will not be reactivated.

The folding and unfolding of the door mirrors by the remote control can be deactivated by a PEUGEOT dealer or a qualified workshop.

Deadlocking

- !** Deadlocking renders the exterior and interior door controls inoperative. It also deactivates the manual central control button. Therefore, never leave anyone inside the vehicle when it is deadlocked.



Using the key

- ☞ Turn the key to the rear in the driver's door lock to lock the vehicle completely.
- ☞ Turn the key to the rear again within five seconds to deadlock the vehicle.

Using the remote control



- ☞ Press the closed padlock to lock the vehicle completely.
- ☞ Press the closed padlock again within five seconds to deadlock the vehicle.

- i** Deadlocking is confirmed by fixed lighting of the direction indicators for approximately two seconds. Depending on version, the door mirrors fold at the same time.

Locating your vehicle

This function allows you to identify your vehicle from a distance, particularly in poor light. Your vehicle must be locked.



☞ Press the closed padlock on the remote control.

This will switch on the courtesy lamps and the direction indicators will flash for around ten seconds.

Remote operation of lighting



A short press this button switches on the lighting remotely (sidelamps, dipped beam headlamps and number plate lamps).

A second press before the end of the timed period cancels the remote lighting.

Anti-theft protection

Electronic engine immobiliser

The key contains an electronic chip which has a special code. When the ignition is switched on, this code must be recognised in order for starting to be possible.

This electronic engine immobiliser locks the engine management system a few minutes after the ignition is switched off and prevents starting of the engine by anyone who does not have the key.

SERVICE In the event of a fault, you are informed by illumination of this warning lamp, an audible signal and a message in the screen.

In this case, your vehicle will not start; contact a PEUGEOT dealer as soon as possible.

i Keep safely, away from your vehicle, the label attached to the keys given to you on acquisition of the vehicle.

Back-up control

For mechanically locking and unlocking the doors in the event of a fault with the central locking system or a battery failure.



Driver's door

- ☞ Insert the key in the lock to lock or unlock the door.

If your vehicle has an alarm, it will not be activated and deactivated on locking and unlocking the vehicle.

Opening a door will trigger the alarm, which can be stopped by switching on the ignition.

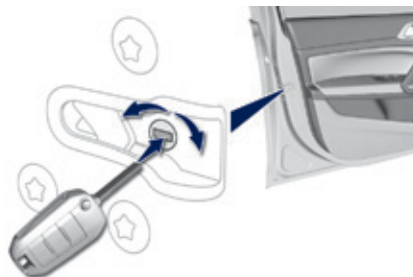

Passenger doors

- ☞ On the rear doors, check that the child lock is not on.
- ☞ Insert the integral key into the latch on the edge of the door and turn it an eighth of a turn to the right, for the right hand side and to the left for the left hand side.
- ☞ Close the doors and check from the outside that they have locked correctly.

i If your vehicle has an alarm, it will not be activated and deactivated on locking and unlocking the vehicle. Opening a door will trigger the alarm, which can be stopped by switching on the ignition.

Remote control problem

Following disconnection of the vehicle battery, replacement of the remote control battery or in the event of a remote control malfunction, you can no longer unlock, lock or locate your vehicle.

- ☞ First of all, use the key in the lock to unlock or lock your vehicle.
- ☞ Then, reinitialise the remote control.

If the problem persists, contact a PEUGEOT dealer as soon as possible.

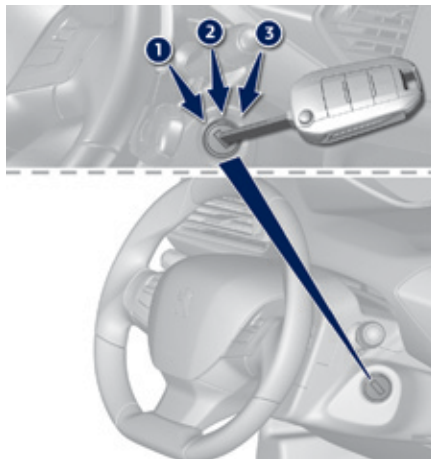

Reinitialisation

- ☞ Switch off the ignition.
- ☞ Turn the key to position **2 (Ignition)**.
- ☞ Press the closed padlock immediately for a few seconds.
- ☞ Switch off the ignition and remove the key from the ignition switch.

The remote control is fully operational again.



Changing the battery

Battery ref.: CR1620 / 3 volts.

SERVICE If the battery is flat, you are informed by lighting of this warning lamp in the instrument panel, an audible signal and a message in the screen.

- ☞ Unclip the cover using a screwdriver in the cutout.
- ☞ Remove the cover.
- ☞ Extract the flat battery from its location.
- ☞ Place the new battery into its location observing the original direction.
- ☞ Clip the cover in place.



Do not throw the remote control batteries away, they contain metals which are harmful to the environment. Take them to an approved collection point.

"Keyless Entry and Starting" with remote control

System which permits central unlocking or locking of the vehicle using the lock barrel or from a distance. It is also used to locate and start the vehicle, as well as providing protection against theft.



Complete unlocking



- ☞ Press the open padlock to unlock the vehicle.

Selective unlocking

Complete unlocking is activated by default.

This setting is done in the **"Driving assistance"** menu, then **"Vehicle settings"** and **"Vehicle access"**.



Use this button for access to additional information.



- ☞ To unlock only the driver's door, press the open padlock once.

- ☞ To unlock the other doors and the boot, press the open padlock again.



Unlocking is confirmed by rapid flashing of the direction indicators for two seconds.

At the same time, depending on version, the door mirrors unfold. And if your vehicle has an alarm, it is deactivated.

Unlocking the boot



- Press this button until the direction indicators flash rapidly. The vehicle is completely unlocked and if your vehicle has an alarm, it is deactivated.

Locking



- Press the closed padlock to lock the vehicle completely. Hold the button down until the windows close completely.

i Locking is confirmed by fixed lighting of the direction indicators for a few seconds. Depending on your version, the door mirrors fold, the alarm is activated.

! Driving with the doors locked may make access to the passenger compartment by the emergency services difficult in the event of an emergency. Be aware of children when operating the windows.



If a door or the boot is not properly closed, with the **engine running** or the **vehicle moving** (speed above 6 mph (10 km/h)), a message appears for a few seconds.

Locating your vehicle



- This function allows you to identify your vehicle from a distance, particularly in poor light. Your vehicle must be locked.
- Press the closed padlock on the remote control.

This will switch on the courtesy lamps and the direction indicators will flash for around ten seconds.

! As a safety measure (children on board), never leave the vehicle without taking the key for the Keyless Entry and Starting system, even for a short period. Guard against theft when the key for the Keyless Entry and Starting system is in the recognition zone with the vehicle unlocked. In order to preserve the charge of the cell battery in the remote control, the "hands-free" functions go into extended stand-by after 21 days of non-use. To restore these functions, press one of the remote control buttons or start the engine with the electronic key in the reader.

"Keyless Entry and Starting" on your person



System that allows the opening, closing and starting of the vehicle while keeping the electronic key on your person.

Complete unlocking



- ☞ With the electronic key on your person and in the recognition zone **A**, pass your hand behind one of the front door handles to unlock the vehicle, then pull on the handle to open the door.

Selective unlocking

When selective unlocking of the driver's door is activated.

- ☞ With the electronic key in the driver's door zone, pass your hand behind the driver's door handle to unlock just the driver's door, then pull on the door handle to open the door.
- ☞ With the electronic key in the passenger's door zone, pass your hand behind the passenger's door handle to unlock the whole vehicle, then pull on the door handle to open the door.

By default, complete unlocking is activated. This setting is done in the **"Driving assistance"** menu, then **"Vehicle settings"** and **"Vehicle access"**.



Use this button for access to additional information.



Unlocking is confirmed by rapid flashing of the direction indicators for a few seconds. Depending on version, the door mirrors unfold, the alarm is deactivated.

- i** The central locking does not take place:
 - if the ignition is on,
 - if one of the doors or the boot is still open,
 - if the key for the Keyless Entry and Starting system has been left inside the vehicle.

When the vehicle is locked, if it is unlocked inadvertently, it will lock itself again automatically after about thirty seconds unless a door is opened.

And if your vehicle has an alarm, this is not reactivated.

The folding and unfolding of the door mirrors by the remote control can be deactivated by a PEUGEOT dealer or a qualified workshop.

Locking

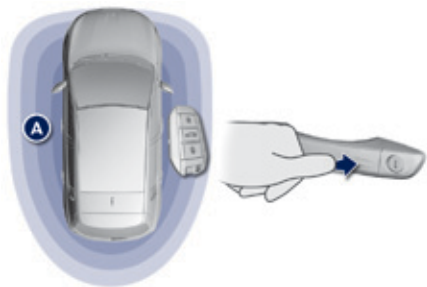

- ☞ With the electronic key in the recognition zone **A**, press with a finger on one of the front door handles (at the markings) to lock the vehicle.
Maintain pressure with your finger until the windows close completely.



If a door or the boot is not properly closed, with the **engine running** or the **vehicle moving** (speed above 6 mph (10 km/h)), a message appears for a few seconds.



- ☞ With the key in the recognition zone **A**, press the tailgate locking control to lock the vehicle.



Locking is confirmed by fixed lighting of the direction indicators for a few seconds. Depending on your version, the door mirrors fold, the alarm is activated.



- ! For reasons of safety and theft protection, do not leave your electronic key in the vehicle, even when you are close to it.

It is recommended that you keep it on your person: in a pocket, bag, ...

- ! Ensure that no one prevents the correct operation of the windows. Be aware of children when operating the windows.

Deadlocking

- ! Deadlocking renders the exterior and interior door controls inoperative. It also deactivates the manual central control button. Therefore, never leave anyone inside the vehicle when it is deadlocked.



- ! Accumulations (water, dust, grime, salt...) on the inner surface of the door handle may affect detection. If cleaning the inner surface of the door handle using a cloth does not restore detection, contact a PEUGEOT dealer or a qualified workshop. A sudden splash of water (stream of water, high pressure jet washer, ...) may be identified by the system as the desire to open the vehicle.

Using the remote control



- ☞ Press the closed padlock to lock the vehicle completely. Maintain pressure with your finger for more than two seconds to close the windows.
- ☞ Press the closed padlock again within five seconds to deadlock the vehicle.

- ! Ensure that no one is preventing the correct closing of the windows. Be aware of children when operating the windows.

With the Keyless Entry and Starting system

By the doors:

- ☞ With the electronic key in the recognition zone **A**, press a finger on the door handle (at the markings) to lock the vehicle.
- ☞ Within five seconds, press the door handle again to deadlock the vehicle.

Boot

Opening using the key



☞ After unlocking the vehicle with the remote control, press the opening control and then raise the tailgate.

Opening using the "Keyless Entry and Starting" remote control

Complete unlocking



☞ Press this button, the vehicle is unlocked.

Selective unlocking

Complete unlocking is selected by default. This setting is done in the "**Driving assistance**" menu, then "**Vehicle settings**" and "**Vehicle access**".



☞ Press this button, the boot is unlocked.



Use this button for access to additional information.

Opening using the Keyless Entry and Starting system



Complete unlocking

- ☞ With the electronic key on your person in the recognition zone **A**, press the opening control then raise the tailgate.

Selective unlocking

By default, complete unlocking is activated. This setting is done in the "**Driving assistance**" menu, then "**Vehicle settings**" and "**Vehicle access**".

When unlocking of the boot only is activated:

- ☞ With the electronic key in the recognition zone **A**, press the boot unlocking control to unlock just the tailgate, then raise the tailgate.

Unlocking is signalled by rapid flashing of the direction indicators for a few seconds.



Use this button for access to additional information.

Closing

- ☞ Lower the tailgate using one of the interior grab handles.

If the boot is not closed correctly (the lock has two positions): with the **engine running** or **when moving** (speed above 6 mph (10 km/h)), a message appears for a few seconds.

Locking with Keyless Entry and Starting



☞ With the electronic key in the recognition zone **A**, press the boot locking control to lock the vehicle.

Locking is signalled by rapid flashing of the direction indicators for a few seconds.

Tailgate release

System allowing the mechanical unlocking of the boot in the event of a battery or central locking system malfunction.



Unlocking

- ☞ Fold back the rear seats to gain access to the lock from inside the boot.
- ☞ Insert a small screwdriver into hole **A** of the lock to unlock the tailgate.
- ☞ Move the latch to the left.

Locking after closing

If the fault persists after closing again, the boot will remain locked.

Back-up key

Unlocking/locking using the integral key with Keyless Entry and Starting

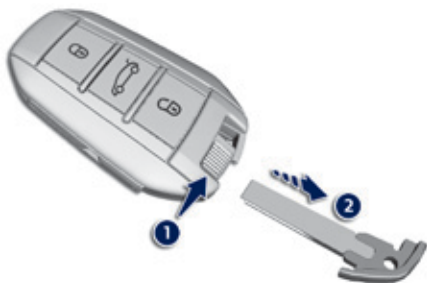

The integral key is used to lock and unlock the vehicle when the electronic key cannot operate:

- cell battery flat, vehicle battery discharged or disconnected, ...
- vehicle located in an area with strong electromagnetic signals.
- ☞ Maintain a pull on button 1, to extract the integral key 2.

i If the alarm is activated, the audible signal on opening a door with the key (integral with the remote control) will stop when the ignition is switched on.



Locking the driver's door

- ☞ Insert the integral key in the door lock, then turn it to the rear.

Unlocking the driver's door

- ☞ Insert the integral key in the door lock, then turn it to the front.



Locking the passenger doors

- ☞ Open the doors.
- ☞ For the rear doors, check that the child lock is not on (see the "Child safety" section).
- ☞ Insert the integral key in the latch located on the edge of the door and turn it an eighth of a turn to the right for the right hand door, and to the left for the left hand door.
- ☞ Close the doors and check that the vehicle has locked correctly from the outside.

Unlocking the passenger doors

- ☞ Pull the interior door opening control.

Changing the cell battery



Battery ref.: CR2032 / 3 volts.

This replacement battery is available from a PEUGEOT dealer or a qualified workshop. A message appears in the instrument panel screen when replacement of the battery is needed.

- ☞ Unclip the cover using a small screwdriver at the cutout.
- ☞ Lift off the cover.
- ☞ Remove the flat battery from its location.
- ☞ Fit the new battery into its location observing the original direction of fitment.
- ☞ Clip the cover onto the casing.



Do not throw the remote control batteries away, they contain metals which are harmful to the environment. Take them to an approved collection point.

Remote control problem - reinitialisation

Following disconnection of the vehicle battery, replacement of the remote control battery or in the event of a remote control malfunction, you can no longer unlock, lock or locate your vehicle.



- ☞ Place the mechanical key (integral with the remote control) in the lock to unlock your vehicle.
- ☞ Remove the mat under 12 V socket.
- ☞ Place the electronic key in the housing provided.
- ☞ Switch on the ignition by pressing START/ STOP.

The electronic key is fully operational again.

If the problem persists, contact a PEUGEOT dealer or a qualified workshop as soon as possible.

! Lost keys, remote control, electronic key

Visit a PEUGEOT dealer with the vehicle's V5 registration document and your personal identification documents. The PEUGEOT dealer will be able to retrieve the key code and the transponder code required to order a replacement.

Remote control

The high frequency remote control is a sensitive system; do not operate it while it is in your pocket as there is a possibility that it may unlock the vehicle, without you being aware of it.

Do not repeatedly press the buttons of your remote control out of range and out of sight of your vehicle. You run the risk of stopping it from working and the remote control would have to be reinitialised.

The remote control does not operate when the key is in the ignition, even when the ignition is switched off.

Locking the vehicle

Driving with the doors locked may make access to the passenger compartment by the emergency services more difficult in an emergency. As a safety precaution (with children on board), remove the key from the ignition or take the electronic key when you leave the vehicle, even for a short time.

Electrical interference

The Keyless Entry and Starting electronic key may not operate if close to certain electronic devices: telephone, laptop computer, strong magnetic fields, ...

Anti-theft protection

Do not make any modifications to the electronic engine immobiliser system; this could cause malfunctions. Don't forget to turn the steering to engage the steering lock.

When purchasing a second-hand vehicle

Have the key codes memorised by a PEUGEOT dealer, to ensure that the keys in your possession are the only ones which can start the vehicle.

Locking/ unlocking from the inside

Automatic central locking of the doors

The doors can lock automatically while driving (speed above 6 mph (10 km/h)).



To activate or deactivate this function, press and hold the button until a message appears in the screen.



☞ Press the button.
This allows the doors and the boot to be locked or unlocked.

! Driving with the doors locked may make access to the passenger compartment by the emergency services more difficult in an emergency.

! If the vehicle is deadlocked or locked with the remote control or the door handles, the button is not active. In this case, use the key or the remote control to unlock.

i When carrying large objects with the boot open, you can press this button to inhibit the boot open alert signal. When locking from inside, the door mirrors do not fold.

Alarm



System which protects and provides a deterrent against theft and break-ins. It provides the following types of monitoring:

Exterior perimeter

The system checks for opening of the vehicle. The alarm is triggered if anyone tries to open a door, the boot or the bonnet...

Interior volumetric

The system checks for any variation in the volume in the passenger compartment. The alarm is triggered if anyone breaks a window, enters the passenger compartment or moves inside the vehicle.

Tilt

The system checks for movement of the vehicle on the ground. The alarm is triggered if the vehicle is lifted, moved or damaged.

! Self-protection function

The system checks for the disconnection of any of its components. The alarm is triggered if the battery, the button or the wires of the siren are disconnected or damaged.

For all work on the alarm system, contact a PEUGEOT dealer or a qualified workshop.

2

Total protection

Activation

- ☞ Switch off the ignition and get out of the vehicle.



- ☞ Lock the vehicle using the remote control.

or

- ☞ Lock the vehicle using the "Keyless Entry and Starting" system.

The monitoring system is active: the indicator lamp in the button flashes once per second and the the direction indicators come on for about 2 seconds.

After an instruction to lock the vehicle using the remote control or the Keyless Entry and Starting system, the exterior perimeter monitoring is activated after a delay of 5 seconds, the interior volumetric monitoring after 45 seconds.

If an opening (door, boot, bonnet...) is not closed fully, the vehicle is not locked but monitoring will be activated after a delay of 45 seconds.

Deactivation



- ☞ Press this unlocking button on the remote control.

or

- ☞ Unlock the vehicle using the "Keyless Entry and Starting" system.

The monitoring system is deactivated: the indicator lamp in the button is off and the direction indicators flash for about 2 seconds.

i If the vehicle self-locks automatically (occurs after 30 seconds if a door or the boot is not opened), the monitoring system is not reactivated automatically. To reactivate the system, it is necessary to unlock and then lock the vehicle again, using the remote control or the "Keyless Entry and Starting" system.

Protection - exterior perimeter monitoring only

Deactivate the interior volumetric monitoring (and tilt monitoring if your vehicle has it) to avoid unwanted triggering of the alarm in certain cases such as:

- occupant(s) present in the vehicle,
- leaving a window partially open,
- washing your vehicle,
- changing a wheel,
- towing your vehicle,
- transport on a ferry.

Volumetric monitoring

Deactivation

The tilt alarm is deactivated as well, if your vehicle has it.



- ☞ Switch of the ignition and within ten seconds press this button until its indicator lamp is on fixed.

- ☞ Get out of the vehicle.
- ☞ Immediately lock the vehicle using the remote control or the "Keyless Entry and Starting" system.

Only the exterior perimeter protection system is active: the indicator lamp in the button flashes once per second.

To be effective, this deactivation must be done every time the ignition is switched off.

Reactivation

The tilt alarm is reactivated as well, if your vehicle has it.

- ☞ Deactivate the exterior perimeter monitoring by unlocking the vehicle using the remote control or the Keyless Entry and Starting system.

The indicator lamp in the button goes off.

- ☞ Reactivate the full alarm system by locking the vehicle using the remote control or the "Keyless Entry and Starting" system.

The indicator lamp in the button flashes once per second again.

Triggering of the alarm

This is indicated by sounding of the siren and flashing of the direction indicators for thirty seconds.

The monitoring functions remain active until the alarm has been triggered eleven times in succession.



When the vehicle is unlocked using the remote control or the Keyless Entry and starting system, rapid flashing of the indicator lamp in the button informs you that the alarm was triggered during your absence. When the ignition is switched on, this flashing stops immediately.

Failure of the remote control

To deactivate the monitoring functions:

- ☞ Unlock the vehicle using the key (integral with the remote control) in the driver's door lock.
- ☞ Open the door; the alarm is triggered.
- ☞ Switch on the ignition; the alarm stops. The indicator lamp in the button goes off.

Locking the vehicle without activating the alarm

- ☞ Lock or deadlock the vehicle using the key (integral with the remote control) in the driver's door lock.

Operating fault



When the ignition is switched on, fixed illumination of the indicator lamp in the button indicates a fault in the system.

Have it checked by a PEUGEOT dealer or a qualified workshop.

Automatic activation

This function is either not available, an option or is standard.

2 minutes after the last door or the boot is closed, the system is activated automatically.

- ☞ To avoid triggering the alarm on entering the vehicle, first press the unlocking button on the remote control or unlock the vehicle using the Keyless Entry and Starting system.

Electric windows



1. Left hand front electric window.
2. Right hand front electric window.
3. Right hand rear electric window.
4. Left hand rear electric window.
5. Deactivating the rear electric window switches.

i Maintaining the locking action (on the key or the remote control) closes the windows automatically.

Manual operation

To open or close the window, press or pull the switch gently. The window stops as soon as the switch is released.

Automatic one-touch operation (depending on version)

To open or close the window, press or pull the switch fully: the window opens or closes completely when the switch is released. Pressing the switch again stops the movement of the window.

The electric window switches remain operational for approximately one minute after the key has been removed. Once this time has elapsed, the electric windows will not operate. To reactivate them, switch the ignition on again.

Safety anti-pinch (depending on version)

When the window rises and meets an obstacle, it stops and immediately partially lowers again. In the event of unwanted opening of the window when closing automatically, press the switch until the window opens completely, then pull the switch immediately until the window closes. Continue to hold the switch for approximately one second after the window has closed. The safety anti-pinch function is not active during this operation.

2

Deactivating the rear window controls



For the safety of your children, press switch **5** to prevent operation of the windows of the rear doors, irrespective of their position.

With the warning lamp on, the rear switches are deactivated. With the warning lamp off, the switches are active.

Reinitialising the electric windows

Following reconnection of the battery, the safety anti-pinch function must be reinitialised. The safety anti-pinch is not active during these operations:

- lower the window completely, then raise it, it will rise in steps of a few centimetres each time the switch is pressed. Repeat the operation until the window closes completely,
- press and hold the switch upwards for at least one second after reaching this position, window closed.



Always remove the key when leaving the vehicle, even for a short time. In the event of contact during operation of the windows, you must reverse the movement of the window. To do this, press the switch concerned. When operating the passenger electric window switches, the driver must ensure that no one is preventing correct closing of the windows. The driver must ensure that the passengers use the electric windows correctly. Be aware of children when operating the windows.

Panoramic sunroof

A panoramic tinted glass surface to improve brightness and vision in the passenger compartment. Its electric blind improves thermal and acoustic comfort.

Electric blind



Opening

- ☞ Press the back of the control without going beyond the point of resistance. The blind stops when you release the control.

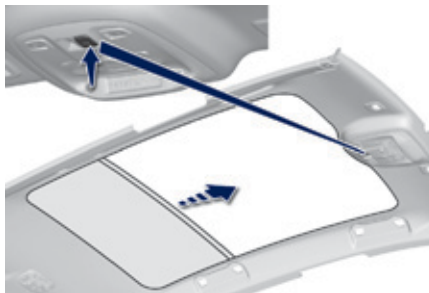

Closing

- ☞ Press the front of the control without going beyond the point of resistance. The blind stops when you release the control.

- ! You can also press or pull the control beyond the point of resistance: the blind opens or closes **completely** after you release the control. Operating the control again stops the movement of the blind.

! Anti-pinch

If the blind encounters an obstacle, you should reverse the movement. Use the control to do this.

Remember to always switch off the ignition when leaving the vehicle, even for a short time.

When operating the control, the driver should ensure that there is nothing preventing movement of the blind. The driver must ensure that passengers use the blind correctly. Be aware of children when operating the blind.

Fuel tank

Capacity of the tank: approximately **53** litres (or **45** litres according to version).

Opening



- If your vehicle has Keyless Entry and Starting, unlock the vehicle.
- Press the filler flap (on the rear side of the vehicle) then pull it.

! With Stop & Start, never refuel with the system in STOP mode; you must switch off the ignition with the key, or the START/STOP button if your vehicle has Keyless Entry and Starting.

Refuelling

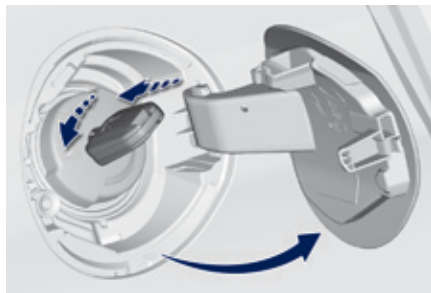

Additions of fuel must be of at least 10 litres to be registered by the fuel gauge. Opening the filler cap may result in an inrush of air. This vacuum is entirely normal and results from the sealing of the fuel system.

- ☞ Take care to select the pump that delivers the correct fuel type for your vehicle's engine (reminder on a label on the inside of the filler flap).
- ☞ Introduce the key into the filler cap, if your vehicle has a normal key.
- ☞ Turn the filler cap to the left.



- ☞ Remove the filler cap and hang it on its carrier (on the filler flap).
- ☞ Introduce the nozzle and push it in fully (pushing on the the metal non-return valve **A**).
- ☞ Fill the tank. Do not continue past the third cut-off of the nozzle, as this may cause malfunctions.
- ☞ Refit the filler cap turning it to the right.
- ☞ Push the filler flap to close it (your vehicle must be unlocked).

Your vehicle is fitted with a catalytic converter, a device which helps to reduce the level of harmful emissions in the exhaust gases.

For petrol engines, you must use unleaded fuel only.

The filler neck is narrower, admitting petrol nozzles only.

! If you have put in the wrong fuel for your vehicle, you must have the tank drained and refilled with the correct fuel before you start the engine.

Low fuel level



When the low fuel level in the tank is reached, this warning lamp comes on in the instrument panel, accompanied by an audible warning and a message.

When it first comes on, less than 10 litres of fuel remain in the tank.

You must refuel as soon as possible to avoid running out.

Fuel supply cut-off

Your vehicle is equipped with a safety device which cuts off the fuel supply in the event of a collision.

Diesel misfuel prevention

Mechanical device which prevents filling the tank of a Diesel vehicle with petrol. It avoids the risk of engine damage that can result from filling with the wrong fuel.

Located in the filler neck, the misfuel prevention device appears when the filler cap is removed.

Operation

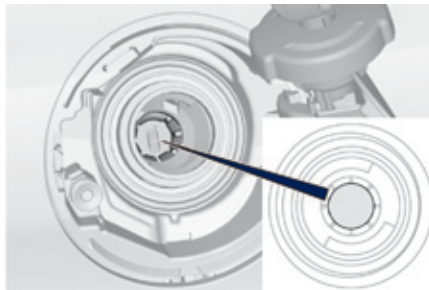

i It is still possible to use a fuel can to fill the tank but this must be done slowly. In order to ensure a good flow of fuel, do not place the nozzle of the fuel can in direct contact with the flap of the misfuel prevention device.

When a petrol filler nozzle is introduced into the fuel filler neck of your Diesel vehicle, it comes into contact with the flap. The system remains closed and prevents filling.

Do not persist but introduce a Diesel filler nozzle.

Travelling abroad

As Diesel fuel pump nozzles may be different in other countries, the presence of the misfuel prevention device may make refuelling impossible.

Before travelling abroad, we recommend that you check with the PEUGEOT dealer network, whether your vehicle is suitable for the fuel pumps in the country in which you want to travel.

Quality of the fuel used for petrol engines

The petrol engines are perfectly compatible with E10 or E24 type petrol biofuels (containing 10 % or 24 % ethanol), conforming to European standards EN 228 and EN 15376.

E85 type fuels (containing up to 85 % ethanol) are reserved exclusively for vehicles marketed for the use of this type of fuel (BioFlex vehicles). The quality of the ethanol must comply with European standard EN 15293.

For Brazil only, special vehicles are marketed to run on fuels containing up to 100 % ethanol (E100 type).



Quality of the fuel used for Diesel engines

The Diesel engines are perfectly compatible with biofuels which conform to current and future European standards (Diesel fuel which complies with standard EN 590 mixed with a biofuel which complies with standard EN 14214) available at the pumps (containing up to 7 % Fatty Acid Methyl Ester).

The B30 biofuel can be used in certain Diesel engines; however, this use is subject to strict application of the special servicing conditions. Contact a PEUGEOT dealer or a qualified workshop.

The use of any other type of (bio)fuel (vegetable or animal oils, pure or diluted, domestic fuel...) is strictly prohibited (risk of damage to the engine and fuel system).



PEUGEOT i-Cockpit



Before taking to the road and to make the most of the special ergonomics of the PEUGEOT i-Cockpit, carry out these adjustments in the following order:

- height of the head restraint,
- backrest angle,
- cushion height,
- longitudinal position of the seat,
- reach and then height of the steering wheel,
- the interior and door mirrors.

! Before moving the seat backwards, ensure that there is nothing that might prevent the full travel of the seat, so as to avoid the risk of jamming the seat caused by the presence of objects on the floor behind the seat or rear passengers. If the seat jams, stop the movement immediately.

i Once these adjustments have been made, ensure that from your driving position you can see the "head-up" instrument panel clearly, over the reduced diameter steering wheel.

Steering wheel adjustment

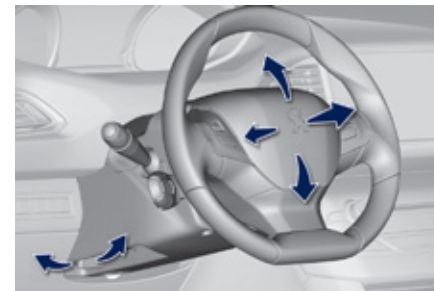

3

- ☞ **When stationary**, lower the control lever to release the steering wheel adjustment mechanism.
- ☞ Adjust the height and reach to suit your driving position.
- ☞ Pull the control lever to lock the steering wheel adjustment mechanism.

! As a safety precaution, these operations should only be carried out while the vehicle is stationary.

Front seats with manual adjustments

As a safety measure, seat adjustments should only be carried out when stationary.

Forwards-backwards



- ☞ Raise the control and slide the seat forwards or backwards.

Height

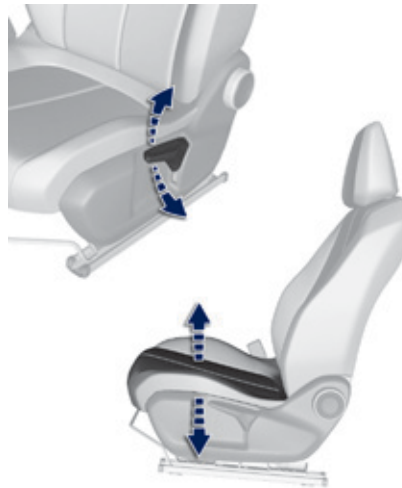

- ☞ Pull the control upwards to raise or push it downwards to lower, as many times as required, to obtain the position required.

Seat backrest angle



- ☞ Turn the knob to adjust the backrest.

Lumbar

- ☞ Turn the knob manually to obtain the desired level of lumbar support.

Electric driver's seat

Forwards-backwards



- ☞ Push the control forwards or rearwards to slide the seat.

Seat backrest angle



- ☞ Tilt the control forwards or rearwards to adjust the angle of the seat backrest.

Seat cushion height and angle

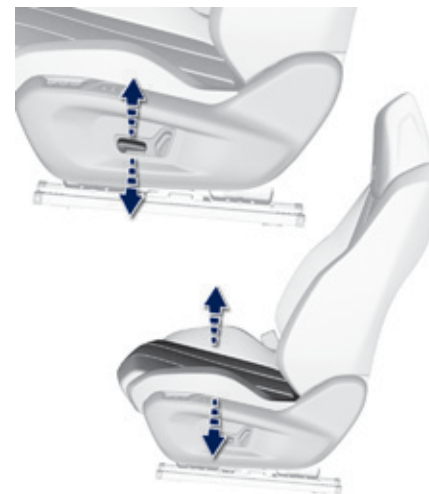

- ☞ Tip the rear of the control upwards or downwards to obtain the desired height.
- ☞ Tip the front of the control upwards or downwards to obtain the desired angle.

i To avoid discharging the battery, carry out these adjustments with the engine running.

Storing driving positions



System which registers the electrical settings of the driver's seat and door mirrors. It enables you to store and recall two positions using the buttons on the side of the driver's seat.

Storing a position

Using buttons M / 1 / 2

- ☞ Switch on the ignition.
- ☞ Adjust your seat and the door mirrors.
- ☞ Press button **M**, then press button **1** or **2** within four seconds.
An audible signal indicates that the position has been stored.

Storing a new position cancels the previous position.

Recalling a stored position

Ignition on or engine running

- ☞ Press button **1** or **2** to recall the corresponding position.
An audible signal confirms that adjustment is complete.

You can interrupt the current movement by pressing button **M**, **1** or **2** or by using one of the seat controls.

A stored position cannot be recalled while driving.

Recalling stored positions is deactivated 45 seconds after switching off the ignition.

Additional adjustments

Head restraint height

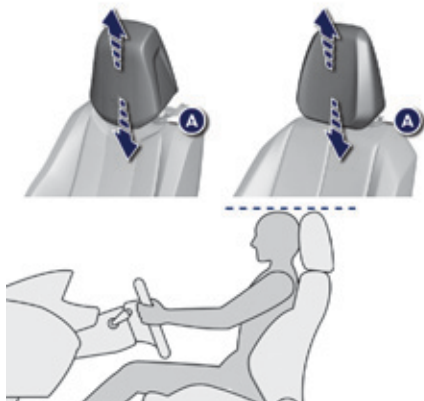

- ☞ To raise the head restraint, pull it upwards.
- ☞ To remove the head restraint, press the lug **A** and pull the head restraint upwards.
- ☞ To put the head restraint back in place, engage the head restraint stems in the openings keeping them in line with the seat back.
- ☞ To lower the head restraint, press the lug **A** and the head restraint at the same time.

! The head restraint is fitted with a frame with notches which prevents it from lowering; this is a safety device in case of impact.

The adjustment is correct when the upper edge of the head restraint is level with the top of the head.

Never drive with the head restraints removed; they must be in place and adjusted correctly.

Heated seats control



With the engine running, the front seats can be heated separately.

- ☞ Use the adjustment wheel to switch on and select the level of heating required:

0: Off.

1: Low.

2: Medium.

3: High.

Electric lumbar adjustment



- Press the control to obtain the desired lumbar support.

Massage function



Activation



- Press this switch.

Its indicator lamp comes on and the massage function is activated for a period of 1 hour. During this time, massage is performed in 6 cycles of 10 minutes (6 minutes of massage followed by 4 minutes break). After one hour, the function is deactivated, the indicator lamp goes off.

Deactivation



You can deactivate the massage function at any time by pressing this switch, its indicator lamp goes off.

This system provides the occupants of the front seats with a lumbar massage. It only operates when the engine is running or in STOP mode of the Stop & Start system.



Adjustment of intensity



Press this button to adjust the intensity of the massage. Two levels of massage are available.

Rear seats (saloon)

Bench seat with fixed one-piece cushion and split backrest (left hand 2/3, right hand 1/3) which can be folded individually to adapt the load space in the boot.

Folding the backrest



- ☞ Move the corresponding front seat forward if necessary.
- ☞ Check that the corresponding outer seat belt is positioned correctly against the backrest and buckle it.
- ☞ Place the head restraints in the low position.



- ☞ Press control 1 to release the seat backrest 2.
- ☞ Fold the seat backrest 2 on to the cushion 3.

! When folding the seat, the centre seat belt should not be fastened, but laid out flat on the seat

i The rear seat cushion does not fold, just the seat backrest can be folded to increase the boot loading space.

Repositioning the seat backrest



- ☞ Straighten the seat backrest 2 and secure it.
- ☞ Check that the red indicator, located next to the control 1, is no longer visible.
- ☞ Unbuckle and reposition the outer seat belt on the side of the backrest.

! When repositioning the seat backrest, take care not to trap the seat belts.

3

Rear seats (SW)

Bench seat, the left-hand (1/3) or right-hand (2/3) section of which can be folded to vary the boot load space.

Folding the seat from the boot

Each section of the bench seat (1/3 or 2/3) has its own control to release the seat back from inside the boot.

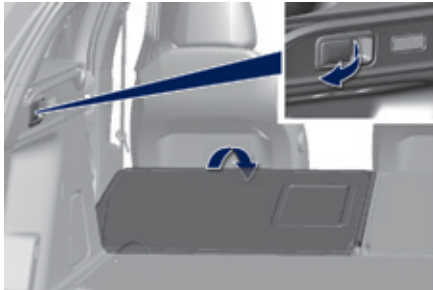

- ☞ Check that nothing is preventing the seat back from folding (seat belts, ...) and that no object might interfere with the seat manoeuvre (above as well as below).
- ☞ Place the head restraints in the low position.



- ☞ Pull the control from inside the boot, the seat backrest folds onto the cushion.

Folding the seat from the rear

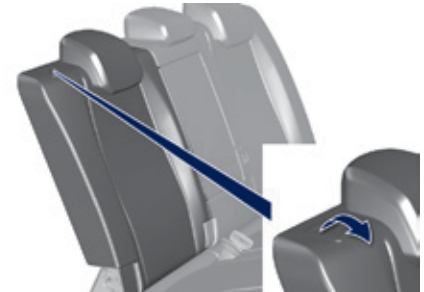

- ☞ Check that nothing is preventing the seat backrest folding and that no object might interfere with the seat manoeuvre (above as well as below).
- ☞ Move the corresponding front seat forwards if necessary.
- ☞ Check that the seat belt is positioned correctly on the side of the seat back.
- ☞ Place the head restraints in the low position.



- ☞ Pull the control **1** forwards, the seat backrest folds onto the cushion.

Returning the seat back to its original position

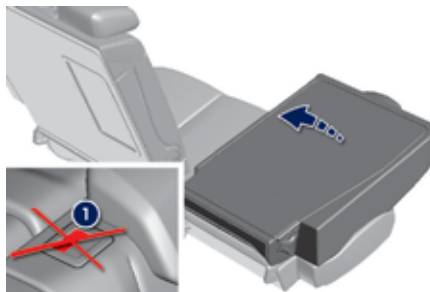

- ☞ Put the seat back in the upright position and secure it.
- ☞ Check that the red indicator, located at the control **1**, is no longer visible.
- ☞ Refit the head restraints or put them back in place.

! When returning the rear seat back to its original position, take care not to trap the seat belts and ensure that their buckles are positioned correctly.

Outer rear seat head restraints



These have one position for use (up) and a stowed position (down). They can be removed and are interchangeable.

To remove a head restraint:

- ☞ pull the head restraint upwards to the stop,
- ☞ then, press the lug **A**.

i The centre head restraint is not adjustable.

! Never drive with the head restraints removed; they must be in place and correctly adjusted.

Interior fittings

1. **Cooled glove box**
Through a ventilation nozzle, if open, engine running and air conditioning on.
2. **12 V accessory socket (120 W)**
Observe the maximum power rating to avoid damaging your accessory.
3. **USB port**
4. **JACK auxiliary socket**
5. **Cup holder (depending on version)**
6. **Storage (depending on version)**
7. **Storage - Retractable cup holder**
Tip the carrier for access to the cup holder.
8. **Front armrest**
9. **230 V (120 W) accessory socket**
Observe the power rating to avoid damaging your accessory.

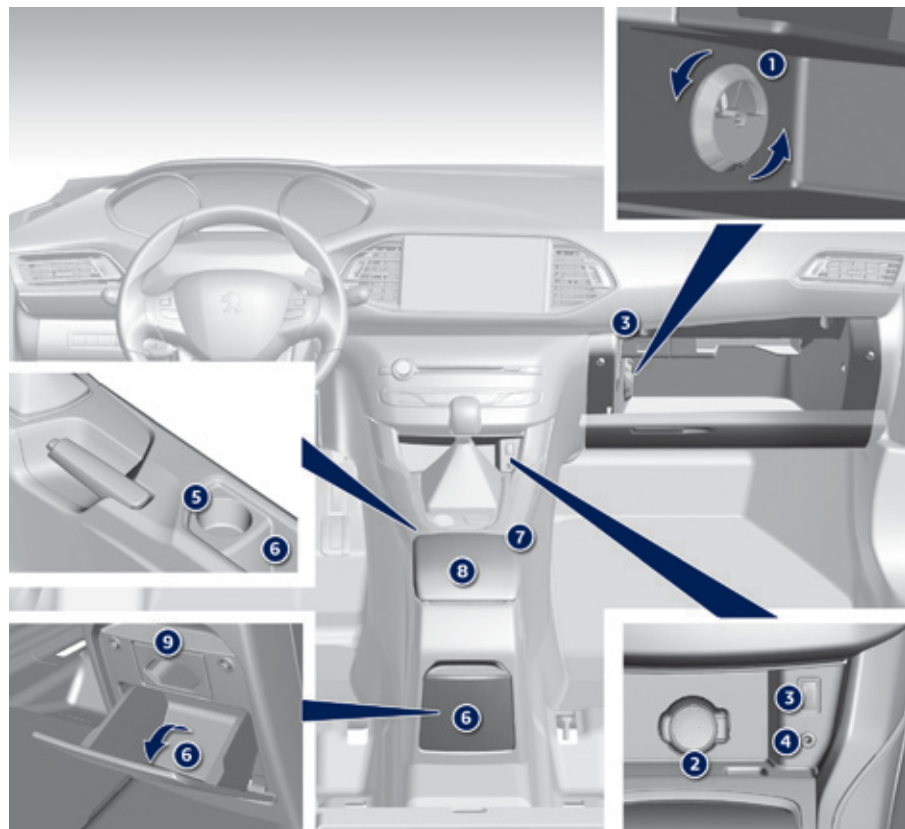

Mats

Removable carpet protection.

Fitting

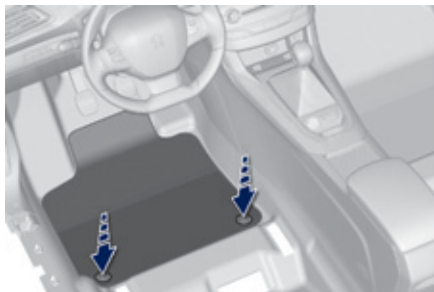

When fitting the mat for the first time, on the driver's side use only the fixings provided in the wallet attached.

The other mats are simply placed on the carpet.

Removal

To remove the mat on the driver's side:

- ☞ move the seat as far back as possible,
- ☞ unclip the fixings,
- ☞ remove the mat.

Refitting

To refit the mat on the driver's side:

- ☞ position the mat correctly,
- ☞ refit the fixings by pressing,
- ☞ check that the mat is secured correctly.



To avoid any risk of jamming of the pedals:

- only use mats which are suited to the fixings already present in the vehicle; these fixings must be used,
- never fit one mat on top of another.

The use of mats not approved by PEUGEOT may interfere with access to the pedals and hinder the operation of the cruise control / speed limiter. The mats approved by PEUGEOT have two fixings located below the seat.

Front armrest

Comfort and storage device for the driver and front passenger.

The height and longitudinal position of the armrest cover can be adjusted for greater comfort.

Height adjustment

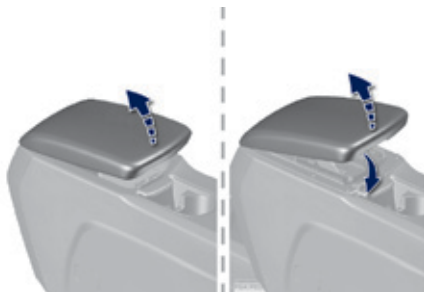

- ☞ Raise the cover to the required position (low, intermediate or high).
- ☞ If you raise the cover slightly beyond the high position, guide it when lowering it to the low position.

Longitudinal adjustment

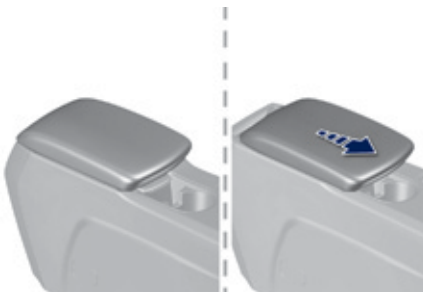

- ☞ Slide the cover fully forwards or rearwards.

Storage



- ☞ Raise the lever.
- ☞ Raise the cover fully.

12 V accessory socket



☞ To connect a 12 V accessory (maximum power: 120 Watts), lift the cover and connect a suitable adaptor.

USB port(s)



It allows the connection of a portable device, such as a digital audio player of the iPod® type or a USB memory stick. It reads the audio files which are transmitted to your audio equipment and played via the vehicle's speakers. You can manage these files using the steering mounted controls or the audio system.

i When a USB port is used, the portable device charges automatically. For more information on using this equipment, refer to the "Audio equipment and telematics" section.

Auxiliary socket



It permits the connection of a portable device, such as a digital audio player of the iPod® type, to listen to your music files using the vehicle's speakers. The management of the files is done using your portable device.

i For more information on the use of this equipment, refer to the "Audio equipment and telematics" section.

230 V / 50 Hz power socket



A 230 V / 50 Hz socket (maximum power: 120 W) is fitted in the rear storage box.

This socket works with the engine running, as well as in STOP mode with Stop & Start.

- ☞ Open the central storage box,
- ☞ Check that the warning lamp is on green,
- ☞ Connect your multimedia or other electrical device (telephone charger, laptop computer, CD-DVD player, baby food warmer...).

In the event of a fault with the socket, the green warning lamp flashes.

Have it checked by a PEUGEOT dealer or a qualified workshop.

! Connect only one device at a time to the socket (no extension or multi-way connector).
Connect only devices with class II insulation (shown on the device).
Do not use a device with a metal case.
As a safety measure, when electrical consumption is high and when required by the vehicle's electrical system (particular weather conditions, electrical overload...), the current supply to the socket will be cut off; the green warning lamp goes off.

i The different "ports and sockets" can be either not available, an option or standard, depending on the trim level of the vehicle.

Rear armrest



☞ Lower the rear armrest for a more comfortable position.

It may be fitted with cup holders and also gives access to the ski flap.

Ski flap

Facility for storing and transporting long objects.

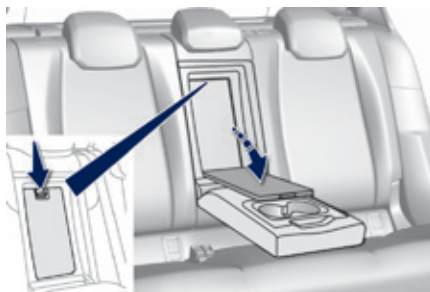

Opening

- ☞ Lower the armrest.
- ☞ Press the flap opening control.
- ☞ Lower the flap.
- ☞ Load the objects from inside the boot.

Do not leave the flap open when not transporting long objects.

Boot fittings (saloon)

1. **Rear parcel shelf**
2. **Boot floor**
Raise the floor for access to the storage.
3. **Storage wells**
in which are stowed:
 - the towing eye,
 - the temporary puncture repair kit,
 - the spare wheel, depending on trim level, an option or standard.
4. **Stowing rings**

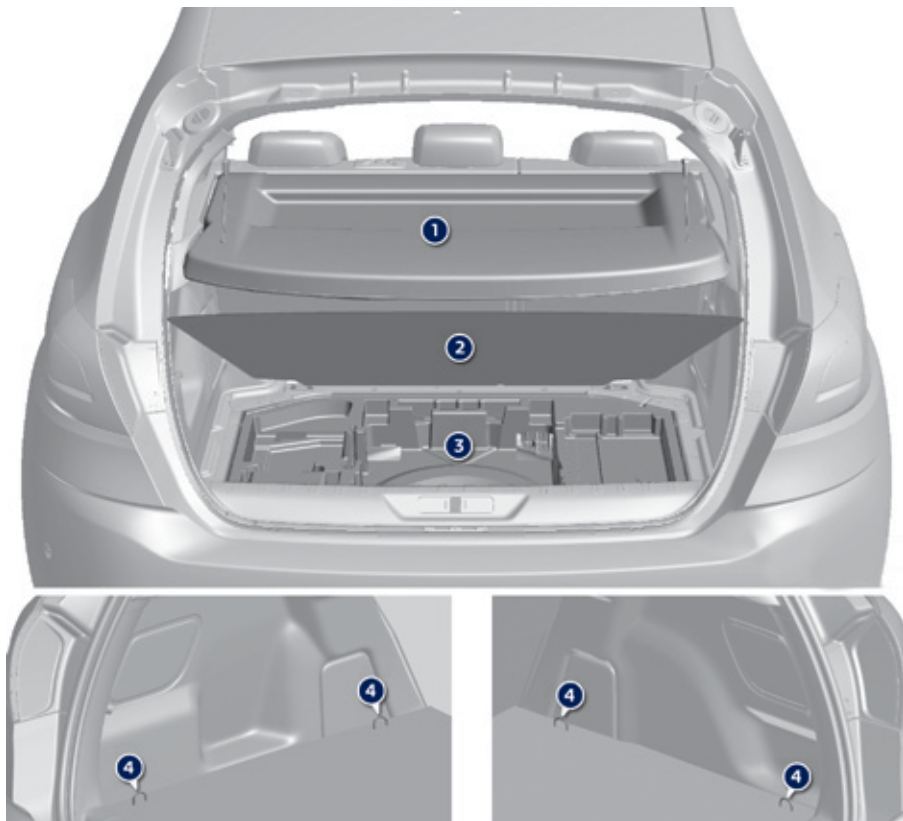

Boot fittings (SW)

1. **Boot lamp**
2. **Rear seat folding controls**
3. **12 V accessory socket (120 W max)**
4. **Removable storage boxes**
Pull on the separations to unclip them.
5. **Storage wells**
where are stowed:
 - the towing eye,
 - the temporary puncture repair kit,
 - the spare wheel, depending on trim level, an option or standard.
6. **Load space cover**
(see corresponding section)

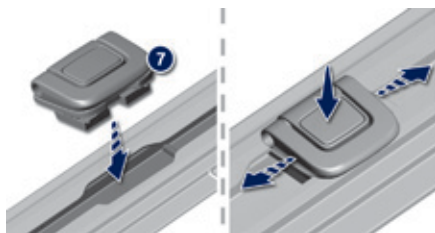

7. Towing eyes

- ☞ Extract the eyes one at a time then slide them into the oblong housing.
- ☞ While pressing the button, move the eye to the desired position.
- ☞ Observe the direction of fitting (rings to the outside of the vehicle).

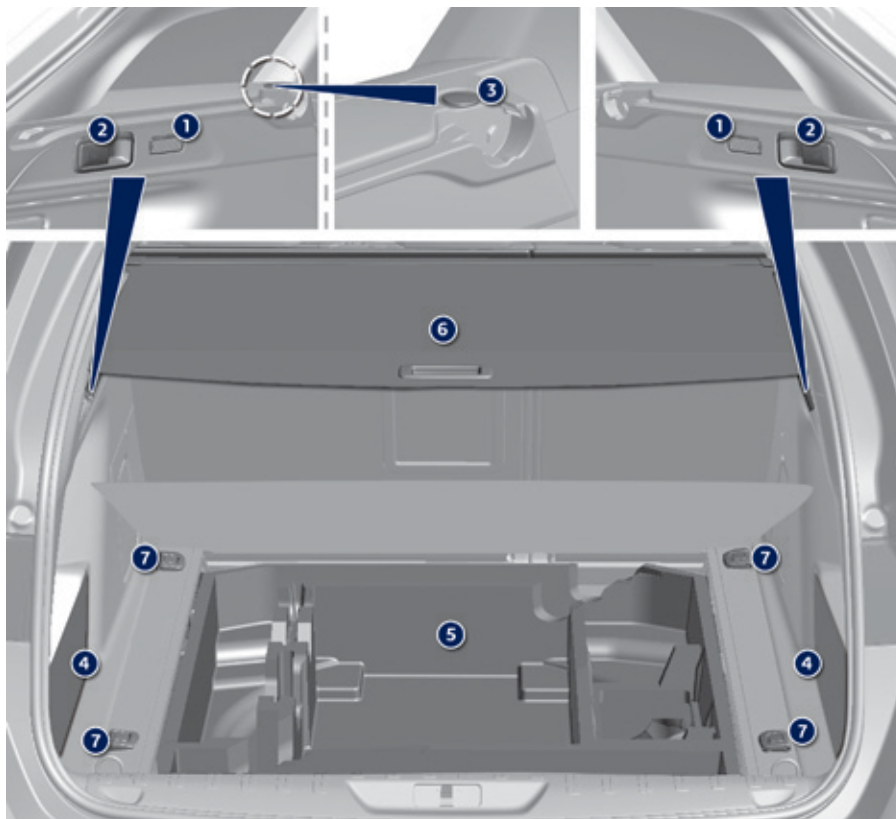

Luggage cover, roller blind (SW)

To reel in

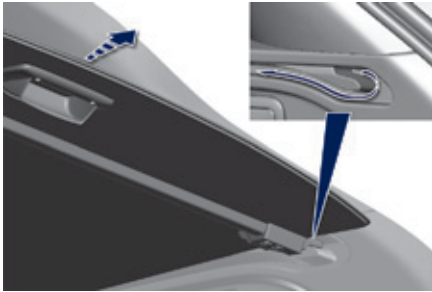

- ☞ Remove the roller guide from the rails in the boot pillars.
- ☞ Release the roller blind, it reels in automatically.

To remove



- ☞ Place a hand on the left **under** the luggage cover.
- ☞ Turn the end of the reel towards the front (clockwise) to release it.
- ☞ Repeat the operation on the right (anti-clockwise).

Storage

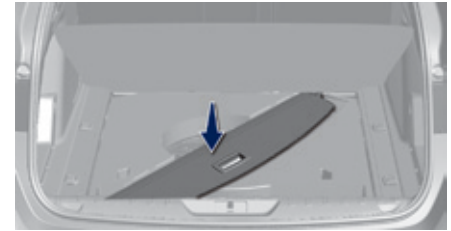

A cut-out in the floor well, under the boot carpet, allows the luggage cover to be stowed diagonally.

To install



- ☞ Position the left and then right hand ends of the luggage cover in their respective housings.
- ☞ Place your hands **on** the roller then turn the assembly to the rear to secure it.
- ☞ Unreel the roller blind until it locks on the rear pillar.

Warning triangle (stowing)

The location for a folded triangle is under the boot floor.

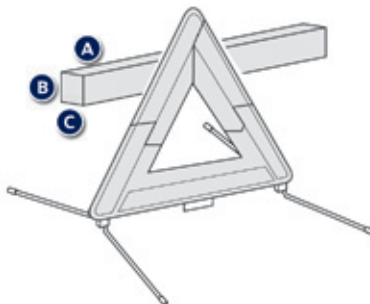
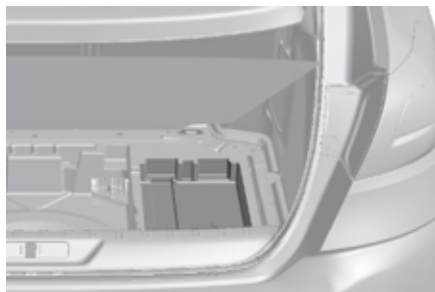

The maximum dimensions of the triangle (once folded) or its storage box must be:

- **A:** length = **44** cm,
- **B:** height = **4** cm,
- **C:** width = **6.5** cm.



Before getting out of your vehicle to assemble the triangle and place it on the road, put on your high visibility vest.



Refer to the manufacturer's instructions for use of the triangle.

Placing the triangle in the road

- ☞ Place the triangle at a distance behind the vehicle, as shown in the table below, according to the type of road and the level of ambient light.

Distance from your vehicle (in metres)		
Road		Motorway
Day	Night	
50 m	80 m	150 m



These are the internationally recognised values. Use the triangle in line with local driving regulations.

The triangle is available as an accessory, contact a PEUGEOT dealer or a qualified workshop.

Heating and Ventilation

System which creates and maintains good conditions of comfort and visibility in the vehicle's passenger compartment.

Air intake

The air circulating in the passenger compartment is filtered and originates either from the outside via the grille located at the base of the windscreen or from the inside in air recirculation mode.

Controls

The incoming air follows various routes depending on the controls selected by the driver, the front passenger and rear passengers, according to the level of equipment.

The temperature control enables you to obtain the level of comfort required by mixing the air of the various circuits.

The air distribution control enables you to select the air vents used in the passenger compartment by the combined use of the associated buttons.

The air flow control enables you to increase or reduce the speed of the ventilation fan. Depending on your vehicle, the controls are accessible in the **"Air conditioning"** menu of the touch screen or are grouped together on control panel on the centre console.

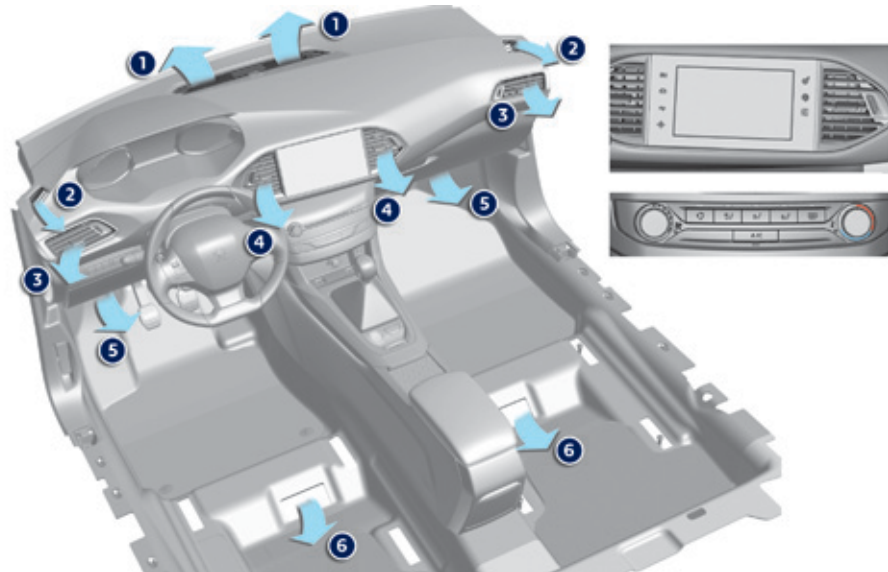

3

Air distribution

1. Windscreen demisting/defrosting vents.
2. Front side window demisting/defrosting vents.
3. Side adjustable air vents.
4. Central adjustable air vents.
5. Air outlets to the front footwells.
6. Air outlets to the rear footwells.

Recommendations for ventilation and air conditioning

- i** In order for these systems to be fully effective, follow the operation and maintenance guidelines below:
- ☞ To obtain an even air distribution, take care not to obstruct the exterior air intake grilles located at the base of the windscreen, the nozzles, the vents and the air outlets, as well as the air extractor located in the boot.
 - ☞ Do not cover the sunshine sensor, located on the dashboard; this is used for regulation of the air conditioning system.
 - ☞ Operate the air conditioning system for at least 5 to 10 minutes, once or twice a month to keep it in perfect working order.
 - ☞ Ensure that the passenger compartment filter is in good condition and have the filter elements replaced regularly.
We recommend the use of a combined passenger compartment filter. Thanks to its special active additive, it contributes to the purification of the air breathed by the occupants and the cleanliness of the passenger compartment (reduction of allergic symptoms, bad odours and greasy deposits).
 - ☞ To ensure correct operation of the air conditioning system, you are also advised to have it checked regularly as recommended in the warranty and maintenance record.
 - ☞ If the system does not produce cold air, switch it off and contact a PEUGEOT dealer or a qualified workshop.

When towing the maximum load on a steep gradient in high temperatures, switching off the air conditioning increases the available engine power and so improves the towing ability.

-  If after an extended stop in sunshine, the interior temperature is very high, first ventilate the passenger compartment for a few moments.
Put the air flow control at a setting high enough to quickly change the air in the passenger compartment.
The air conditioning system does not contain chlorine and does not present any danger to the ozone layer.

- i** The condensation created by the air conditioning results in a discharge of water under the vehicle which is perfectly normal.

i Stop & Start

The heating and air conditioning systems only work when the engine is running. To maintain a comfortable temperature in the passenger compartment, you can temporarily deactivate the Stop & Start system (see the corresponding section).

Heating / Ventilation



Temperature adjustment



Turn the dial from blue (cold) to red (hot) to adjust the temperature to your requirements.

Air flow adjustment



Turn the dial to obtain a comfortable air flow.

Manual air conditioning

The air conditioning system only operates with the engine running.



3

i If you put the air flow control in the **minimum** position (system off), the temperature is no longer controlled. However, a slight flow of air can still be felt, resulting from the movement of the vehicle.

Air distribution adjustment



Windscreen and side windows.



Central and side vents.



Footwells.

The air distribution can be adapted by adding the corresponding buttons.

Air conditioning On / Off



The air conditioning is designed to operate effectively in all seasons, with the windows closed.

It enables you to:

- lower the temperature, in summer,
- increase the effectiveness of the demisting in winter, above 3°C.

Switching on

- ☞ Press this button, its indicator lamp comes on.

i The air conditioning does not operate when the air flow adjustment is set to off.

To obtain cool air more quickly, you can use interior air recirculation for a few moments. Then return to the intake of exterior air.

Switching off

- ☞ Press this button again, its indicator lamp goes off.

Switching off may result in some discomfort (humidity, misting).

Manual air conditioning (Touch screen)

The air conditioning system operates with the engine running.



Press the button for the "**Air conditioning**" menu to display the system controls page.

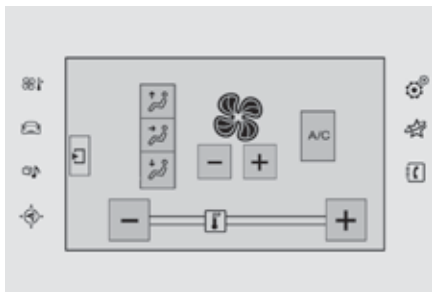

Temperature adjustment



Press one of these buttons to reduce or increase the value.

Air flow adjustment



Press one of these buttons to increase or decrease the speed of the air booster fan.

The air flow symbol (a fan) fills progressively according to the quantity of air wanted. By reducing the air flow to minimum, you are stopping ventilation.

i Avoid driving too long without ventilation (risk of misting and deterioration of air quality).

Air distribution adjustment

These buttons are used to arrange the distribution of air in the passenger compartment by combining several air outlets.



Windscreen.



Central and side vents.



Footwells.

The air distribution can be adapted by using several buttons: illumination of the indicator lamp confirms the presence of fan boosted air in the direction indicated, the indicator lamp off indicates the absence of fan boosted air in the direction indicated.

For a uniform distribution of air in the passenger compartment, the three buttons can be activated simultaneously.

Air conditioning On / Off

A/C

The air conditioning is designed to operate effectively in all seasons, with the windows closed.

It enables you to:

- lower the temperature, in summer,
- increase the effectiveness of the demisting in winter, above 3°C.

Switching on

A/C

Press this button, its indicator lamp comes on.

i The air conditioning does not operate when the air flow adjustment is set to off.

To obtain cool air more quickly, you can use interior air recirculation for a few moments. Then return to the intake of exterior air.

Switching off

A/C

Press this button again, its indicator lamp goes off.

Switching off may result in some discomfort (humidity, misting).

Dual-zone digital air conditioning (Touch screen)

This air conditioning system operates with the engine running, but the ventilation and its controls are available with the ignition on.

Operation of the air conditioning and regulation of temperature, air flow and air distribution in the passenger compartment are automatic according to the temperature in the passenger compartment and the temperature setting.



Press the button for the **"Air conditioning"** menu to display the controls for the air conditioning system.

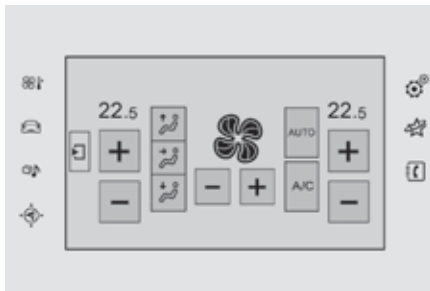

Temperature adjustment

The driver and front passenger can each set the temperature.



- ☞ Press one of these buttons to increase the value.
- ☞ Press one of these buttons to decrease the value.

The value indicated corresponds to a level of comfort and not to a temperature in degrees Centigrade or Fahrenheit (depending on the units chosen).

A setting around 21 provides an optimum level of comfort. Depending on your requirements, a setting between 18 and 24 is normal.

In addition, it is recommended that you avoid a difference between the left and right setting of more than 3.

Automatic comfort programme

AUTO  Press the **"AUTO"** button to activate or deactivate the automatic mode of the air conditioning system.

When the indicator lamp in the button is on, the air conditioning system operates automatically: the system manages the temperature, air flow and air distribution in the passenger compartment in an optimum way according to the comfort level you have selected.

 It is possible to modulate the intensity of the automatic comfort programme by choosing one of three mode settings offered in a secondary page of the **"Air conditioning"** menu.



To change the current setting, shown by the green indicator lamp, press the button for the desired mode:



"Soft": provides soft and quiet operation by limiting air flow.



"Normal": offers the best compromise between a comfortable temperature and quiet operation (default setting).



"Fast": provides strong and effective air flow.

This setting is associated with AUTO mode only. However, on deactivation of AUTO mode, the indicator for the last setting remains on. Changing the setting does not reactivate AUTO mode if deactivated.

i In cold conditions and when the engine is cold, to limit distribution of cold air in the passenger compartment, the air flow will change gradually until the comfort setting is reached. On entering the vehicle, if the interior temperature is much colder or warmer than the comfort value setting, there is no need to alter the value displayed in order to reach more quickly the required level of comfort. The system compensates automatically and corrects the temperature difference as quickly as possible.

Resuming manual control

You can manually adjust one or more settings, while retaining automatic control of the other functions:

- air flow,
- air distribution.

As soon as you modify a setting, the indicator lamp in the "AUTO" button goes off.

- ☞ Press the "AUTO" button again to activate the automatic comfort programme again.
- AUTO

Air flow adjustment



- ☞ Press one of these buttons to increase or decrease the speed of the booster fan.

The air flow symbol (a fan) is filled in progressively in relation to the quantity of air wanted.

By reducing the air flow to minimum, you are stopping ventilation.

"OFF" is displayed alongside the fan.

! Avoid driving for too long with the ventilation off (risk of misting and deterioration of air quality).

Air distribution adjustment

You can modulate the distribution of air in the passenger compartment using these three buttons.

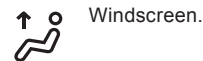

Windscreen.



Footwells.



Centre and side vents.

Each press on a button activates or deactivates the function. The indicator lamp is on when the button is activated. For a uniform distribution in the passenger compartment, all three buttons can be pressed simultaneously.

In AUTO mode, the indicator lamps in all three buttons are off.

Air conditioning On/Off

A/C The air conditioning is designed to operate efficiently in all seasons, with the windows closed.

It allows you:

- in summer, to lower the temperature,
- in winter, above 3 °C, to improve demisting.

Switching on

☞ Press the **"A/C"** button to activate the air conditioning
When the indicator lamp under the button is on, the air conditioning function is activated.

The air conditioning cannot operate when the air flow is set to off.

Switching off

☞ Press the **"A/C"** button again to deactivate the air conditioning
When the indicator lamp under the button is off, the air conditioning function is deactivated.

Ventilation with "ignition on" function

With the ignition on, you can use the ventilation system and have access to the **"Air conditioning"** menu to adjust the **air flow** and **air distribution** in the passenger compartment.

This function is available for a few minutes, depending on the state of charge of the battery of your vehicle.

i This function does not activate the air conditioning.
You can make use of the residual heat in the engine to warm the passenger compartment using the temperature setting buttons.

"Mono" function

The comfort setting for the passenger's side can be indexed to the driver's comfort setting (mono-zone).

From the secondary page of the **"Air conditioning"** menu:



☞ Press this button to activate / deactivate the "Mono" function.
The indicator lamp in the button is on when the function is activated.

The function is deactivated automatically when the passenger uses their temperature setting buttons.

Air intake / Air recirculation



The intake of exterior air avoids misting of the windscreen and side windows.

The recirculation of interior air insulates the passenger compartment from exterior odours and smoke.

i This allows hot or cold air to be delivered quickly when required.



☞ Press this button to recirculate the interior air. Its indicator lamp comes on.



☞ Press the button again to allow fresh air into the passenger compartment. Its indicator lamp goes off.

i Return to exterior air intake as soon as possible to prevent deterioration of the air quality and the formation of mist.

Front demist - defrost



These markings on the control panel indicate the control positions for rapid demisting or defrosting of the windscreen and side windows.

With manual air conditioning



- ☞ Put the air flow, temperature and distribution controls to the dedicated marked position.
- ☞ Press the **"A/C"** button for air conditioning; the indicator lamp in the button comes on.

With manual or dual-zone digital air conditioning

(with the touch screen)



- ☞ Press this button to demist or defrost the windscreen and side windows as quickly as possible.

The system automatically manages the air conditioning, air flow and air intake, and provides optimum distribution towards the windscreen and side windows.

- ☞ To stop, press this button again or on **"AUTO"**.

The system reverts to the previous settings.

i With Stop & Start, when demisting has been activated, the STOP mode is not available.

Rear screen demist - defrost

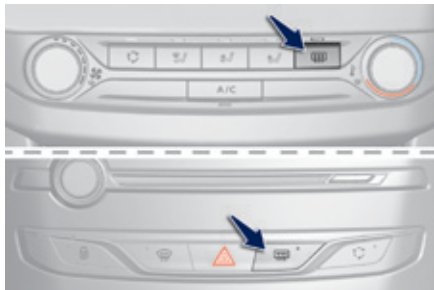

Switching on



- ☞ Press this button to demist/defrost the rear screen and (depending on version) the door mirrors. The indicator lamp associated with the button comes on.

Switching off

The demisting/defrosting switches off automatically to prevent an excessive consumption of current.



- ☞ It is possible to stop the demisting/defrosting operation before it is switched off automatically by pressing the button again. The indicator lamp associated with the button switches off.



Switch off the heating of the rear screen and door mirrors as soon as you judge it possible, as reducing the consumption of electrical current reduces fuel consumption.



The rear screen demist - defrost can only operate when the engine is running.

Starting-switching off the engine, remote control

Put the gear lever into neutral.

Ignition switch

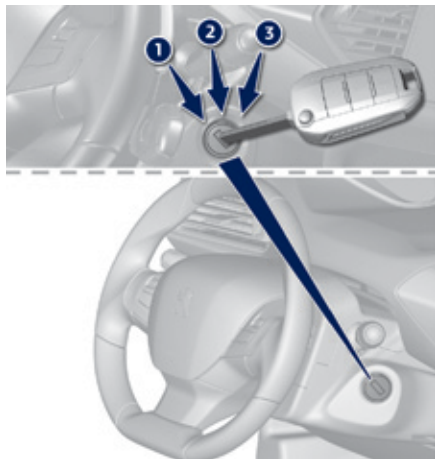

1. **Stop** position.
2. **Ignition on** position.
3. **Starting** position.

Starting using the key

- ☞ Insert the key in the ignition switch.
The system recognises the starting code.
- ☞ Turn the key fully towards the dashboard to position **3 (Starting)**.
- ☞ When the engine starts, release the key.

Switching off using the key

- ☞ Immobilise the vehicle.
- ☞ Turn the key fully towards you to position **1 (Stop)**.
- ☞ Remove the key from the ignition switch.

! Switching off the engine leads to a loss of braking assistance.

i A heavy object (key fob...), attached to the key and weighing down on its shaft in the ignition switch, could cause a malfunction.

i Key left in the "Ignition on" position

On opening the driver's door, an alert message is displayed, accompanied by an audible signal, to remind you that the key is still in the ignition switch at position **1 (Stop)**.

If the key has been left in the ignition switch at position **2 (Ignition on)**, the ignition will be switched off automatically after one hour.

To switch the ignition back on, turn the key to position **1 (Stop)**, then back to position **2 (Ignition on)**.

Starting and switching off the engine, "Keyless Entry and Starting"

Starting



☞ With the electronic key inside the vehicle, depress the clutch pedal fully and maintain pressure until the engine starts.



☞ Press the "START/STOP" button.

☞ The steering column unlocks and the engine starts more or less immediately. (Read the information on Diesel versions).



For **Diesel vehicles**, in sub-zero temperatures the engine will not start until the pre-heater warning lamp has gone off. If this warning lamp comes on after pressing the "START/STOP" button, press down on the brake or clutch pedal until the warning lamp goes off, without pressing the "START/STOP" button again, until the engine starts and runs.



The presence in the recognition zone of the electronic key of the "Keyless Entry and Starting" system is essential. For reasons of safety, do not leave this zone while the engine is running. A message is displayed if the electronic key is not detected in the zone. Move the electronic key into the zone to be able to start the engine.



If one of the starting conditions is not met, a reminder message appears in the instrument panel screen. In some circumstances, it is necessary to turn the steering wheel slightly while pressing the "START/STOP" button to assist unlocking of the steering; a message warns you when this is needed.

Switching off

- ☞ Immobilise the vehicle.



- ☞ With the electronic key inside the vehicle, press the "START/STOP" button.

The engine stops and the steering column is locked.

i If the vehicle is not immobilised, the engine will not stop.

Ignition on position (accessories)



Pressing the "START/STOP" button, with no action on the pedals, allows the ignition to be switched on and so activate the ancillary equipment.



- ☞ Press the "START/STOP" button, the instrument panel comes on but the engine does not start.

- ☞ Press the button again to switch off the ignition and so allow the vehicle to be locked.

i If you use the accessory position for too long, the system automatically goes into economy mode to avoid the risk of a flat battery.

Emergency starting



When the electronic key is in the recognition zone and your vehicle does not start after pressing the "START/STOP" button:

- ☞ Insert the electronic key in the reader.
- ☞ Fully declutch.
- ☞ Press the "START/STOP" button. The engine starts.

Emergency switch-off



In the event of an emergency only, the engine can be switched off without conditions. To do this, press and hold the "START/STOP" button for about 3 seconds.

In this case the steering column locks as soon as the vehicle stops.

Remote control not recognised



If the electronic key is no longer in the recognition zone when you close a door or when you (later) request switching off the engine, a message appears in the instrument panel.



- ☞ Press and hold the "START/STOP" button for about 3 seconds if you want to force switching off the engine.

i Key left in reader

You are warned by a message if the electronic key is still in the reader on opening the driver's door.

Anti-theft protection

Electronic engine immobiliser

The keys contain an electronic chip which has a secret code. When the ignition is switched on, this code must be recognised in order for starting to be possible.

This electronic engine immobiliser locks the engine management system a few minutes after the ignition is switched off and prevents starting of the engine by anyone who does not have the key.

In the event of a malfunction, you are informed by a message in the instrument panel screen. In this case, your vehicle does not start; contact a PEUGEOT dealer as soon as possible.



! For reasons of safety and theft protection, do not leave your electronic key in the vehicle, even when you are close to it.

It is recommended that you keep it on your person: in a pocket, bag, ...

Manual parking brake



Application

- ☞ With your foot on the brake pedal, pull the parking brake lever up to immobilise your vehicle.

Release

- ☞ With your foot on the brake pedal, pull the parking brake lever up gently, press the release button then lower the lever fully.



When the vehicle is being driven, this warning lamp coming on, accompanied by an audible signal and a message, indicates that the parking brake is still on or has not been fully released.



When parking on a slope, direct your wheels against the kerb, apply the parking brake, engage a gear and switch off the ignition.



Pressing the brake pedal facilitates the application and release of the manual parking brake.

Electric parking brake

Automatic operation



The system allows the application of the parking brake on switching off the engine and release as the vehicle moves off.

Indicator lamp



This indicator lamp comes on in the instrument panel and in the control lever to confirm the application of the parking brake.



It goes off to confirm the release of the parking brake.

The driver can take over at any time to apply or release the parking brake, by operating the control lever.



- By briefly **pulling** the control lever to apply the brake,



- By briefly **pushing** the control lever, while pressing the foot brake, to release.



The indicator lamp in the control lever flashes during manual application or release.



In the event of a battery failure, the electric parking brake no longer works. As a safety measure, if the parking brake is not applied, immobilise the vehicle by engaging a gear or placing a chock at one of the wheels. Contact a PEUGEOT dealer or a qualified workshop.



Never leave a child alone inside the vehicle with the ignition on, as they could release the parking brake.



When towing, parking on a steep slope, or if your vehicle is heavily laden, turn the wheels towards the kerb and engage a gear. For towing, your vehicle is approved for parking on slopes of up to 12%.

Automatic operation

Automatic release

Ensure first that the engine is running and the driver's door is properly closed.

The electric parking brake **releases automatically and progressively** when you press the accelerator:

- ☞ Fully depress the clutch pedal, engage 1st or reverse gear; press the accelerator pedal and let up the clutch pedal.



The complete release of the parking brake is confirmed by the brake indicator lamp and the **P** indicator lamp in the control lever going off, accompanied by the display of the message "Parking brake released".



- ! When stationary with the engine running, do not depress the accelerator pedal unnecessarily, you risk releasing the parking brake.

Automatic application

With the vehicle stationary, the parking brake is **automatically applied when the ignition is switched off**.



Application of the parking brake is confirmed by illumination of the brake indicator lamp and the **P** indicator lamp in the control lever, accompanied by the display of the message "Parking brake applied".



With the engine stalled or in STOP mode of Stop & Start, automatic application does not take place.



With automatic operation, you can manually apply or release the parking brake using the control lever.

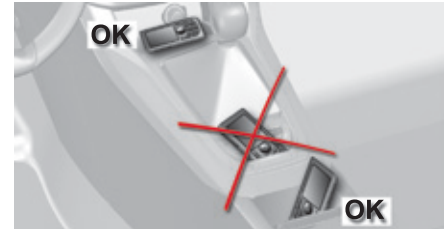

The area in front of the electric parking brake control is not intended for the storage of objects.

4

Manual operation

Manual release

With the ignition on or the engine running, to release the parking brake:

- ☞ press the brake pedal,
- ☞ briefly push the control lever.

The complete release of the parking brake is confirmed by the brake indicator lamp and the **P** indicator lamp in the control lever going off, accompanied by the display of the message "Parking brake released" and an audible signal until the doors are closed.

- i** If you push the control lever without pressing the brake pedal, the parking brake will not be released and a message is displayed.

Manual application

With the vehicle stationary: briefly pull the control lever.

Confirmation of the instruction is signaled by flashing of the indicator lamp in the control lever.



Application of the parking brake is confirmed by illumination of the brake indicator lamp and the



P indicator lamp in the control lever, accompanied by the display of the message "Parking brake applied".

Label on door panel

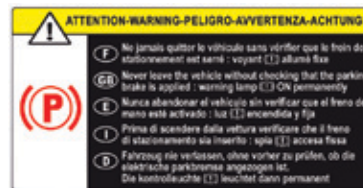

- i** Before leaving the vehicle, check that parking brake is applied: the indicator lamps in the instrument panel and the control lever must be on fixed, not flashing.
If the parking brake is not applied, there is an audible signal and a message is displayed on opening the driver's door.

Immobilisation of the vehicle (special cases)

In some situations, you may need to operate the parking brake manually.

Engine running

To immobilise the vehicle with the engine running, briefly pull the control lever.



Application of the parking brake is confirmed by illumination of the brake indicator lamp and the **P** indicator lamp in the control lever, accompanied by the display of the message "Parking brake applied".



Without applying the parking brake (ice)

! In very cold conditions, it is recommended that the parking brake not be applied (risk of freezing). To immobilise your vehicle, engage a gear or fit a chock to one of the wheels.

- ☞ Switch off the engine.
Release of the parking brake is confirmed by illumination of the indicator lamps in the instrument panel and the control lever.
- ☞ Switch on the ignition again, without starting the engine.

- ☞ Release the parking brake manually by pushing the control lever while keeping your foot on the brake.



The complete release of the parking brake is confirmed by the brake indicator lamp and the **P** indicator lamp in the control lever going off, accompanied by the display of the message "Parking brake released".



- ☞ Switch off the ignition.

4

Deactivating automatic operation

In some situations, such as very cold weather or towing (caravan, recovery), it may be necessary to deactivate automatic operation of the system.

- ☞ Start the engine.
- ☞ Apply the parking brake with the control lever, if it is released.
- ☞ Take your foot off the brake pedal.
- ☞ Push and hold the control lever in the release direction for at least 10 seconds and no more than 15 seconds.
- ☞ Release the control lever.
- ☞ Press and hold the brake pedal.
- ☞ Pull the control lever in the apply direction for 2 seconds.



Deactivation of the automatic functions is confirmed by illumination of this indicator lamp in the instrument panel.

- ☞ Release the control lever and the brake pedal.

From this point the parking brake can only be applied and released manually using the control lever.

Repeat this procedure to reactivate automatic operation.

Reactivation of automatic operation is confirmed by the indicator lamp in the instrument panel going off.

Emergency braking



The emergency braking should only be used in an exceptional situation.

In the event of a failure of the main service brake or in an exceptional situation (e.g. driver taken ill, under instruction, etc) a continuous pull on the control lever will brake the vehicle. Braking takes place while the control lever is being pulled. It is interrupted if the control lever is released.

The ABS and DSC systems provide stability of the vehicle during emergency braking.

If the emergency braking malfunctions, the message "Parking brake control faulty" will be displayed.











If a failure of the ABS and DSC systems, signalled by the illumination of one or both warning lamps in the instrument panel, then stability of the vehicle is no longer guaranteed. In this event, stability must be assured by the driver by repeating alternate "pull-release" actions on the control lever until the vehicle is immobilised.

Operating faults

The various alert situations are described in the table below.

In the event of a fault with the electric parking brake it is recommended that you contact a PEUGEOT dealer or a qualified workshop without delay.

Situations	Consequences
Display of the message "Parking brake fault" and the following warning lamps: SERVICE	<ul style="list-style-type: none"> - Automatic release is not available. - If you attempt an automatic release, a help message is displayed on acceleration when the parking brake is applied, prompting you to use manual release.
Display of the message "Parking brake fault" and of the following warning lamps: SERVICE 	<ul style="list-style-type: none"> - Back-up braking does not have full power. - If automatic release is not available, a help message is displayed on acceleration when the parking brake is applied, prompting you to use manual release.
Display of the message "Parking brake fault" and of the following warning lamps: SERVICE 	<ul style="list-style-type: none"> - Automatic application is not available: use the control lever. - The electric parking brake can only be used manually. - If automatic release is also not available, a help message is displayed on acceleration when the parking brake is applied, prompting you to use manual release.
Display of the message "Parking brake fault" and of the following warning lamps: SERVICE 	<ul style="list-style-type: none"> - If manual application and release do not work, the control lever is faulty. - The automatic functions must be used in all circumstances: they are automatically reactivated in the event of failure of the control lever. - You can no longer immobilise the vehicle with the engine running.

Situations	Consequences
<p>Display of the message "Parking brake fault" and of the following warning lamps:</p> <p>SERVICE  </p>	<p>The parking brake is faulty, the manual and automatic functions may not operate.</p> <p>When stationary, to immobilise your vehicle:</p> <ul style="list-style-type: none"> - Pull and hold the control lever for about 7 to 15 seconds, until the warning lamp comes on in the instrument panel. <p>If this procedure does not work, you should make your vehicle safe:</p> <ul style="list-style-type: none"> - Park on a level surface. - Engage a gear. - If possible, fit a wheel chock. <p>Call on a PEUGEOT dealer or a qualified workshop.</p>
<p>Display of the message "Parking brake fault" and of the following warning lamps:</p> <p>SERVICE   </p>	<ul style="list-style-type: none"> - The parking brake does not have its full performance to securely hold the vehicle in all situations. <p>You should make your vehicle safe:</p> <ul style="list-style-type: none"> - Park on a level surface. - Engage a gear. - If possible, fit a wheel chock. <p>Call on a PEUGEOT dealer or a qualified workshop.</p> <p>The flashing of the P warning lamps on starting the vehicle indicates that the parking brake is not correctly applied.</p> <p>As soon as possible, stop the vehicle and try to completely release the parking brake, using the control lever, with your foot on the brake pedal.</p>
<p>Display of the message "Battery fault" and the following warning lamp:</p> <p></p>	<ul style="list-style-type: none"> - The state of charge of the battery is very low and requires immobilisation of the vehicle in a safe place. - Once the battery is completely discharged, the controls do not operate: to release the parking brake, call on a PEUGEOT dealer or a qualified workshop.

Hill start assist

System which keeps your vehicle immobilised temporarily (approximately 2 seconds) when starting on a gradient, the time it takes to move your foot from the brake pedal to the accelerator pedal. This system is either not available or is standard.

It only operates when:

- the vehicle is completely stationary, with your foot on the brake pedal,
- particular conditions on a slope are met,
- with the driver's door closed.

This hill start assist system cannot be deactivated.

! Do not leave the vehicle while it is being held in the hill start assist phase. If you need to get out of the vehicle with the engine running, apply the parking brake manually then ensure that the parking brake indicator lamp (and the **P** indicator lamp in the electric parking brake control lever) are on fixed (not flashing).

Operation



On an ascending slope, with the vehicle stationary, the vehicle is held for a momentarily when you release the brake pedal:

- if you are in first gear or neutral with a manual gearbox,
- if you are in position **D** or **M** with an automatic gearbox.

On a descending slope, with the vehicle stationary and reverse gear engaged, the vehicle is held momentarily when you release the brake pedal.

Operating fault



If a fault in the system occurs, this warning lamp comes on accompanied by a message. Contact a PEUGEOT dealer or a qualified workshop to have the system checked.

5-speed manual gearbox

Engaging reverse gear



- ☞ With clutch pedal fully down, place the gear lever in neutral.
- ☞ Push the gear lever to the right then backwards.

! Only engage reverse gear when the vehicle is stationary with the engine at idle.

- i** As a safety precaution and to facilitate starting of the engine:
- always select neutral,
 - press the clutch pedal.

6-speed manual gearbox

Engaging 5th or 6th gear

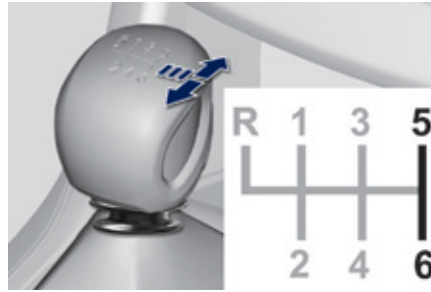

- ☞ Move the lever fully to the right to engage 5th or 6th gear.

! Failure to follow this advice may cause permanent damage to the gearbox (engagement of 3rd or 4th gear by mistake).

Engaging reverse gear

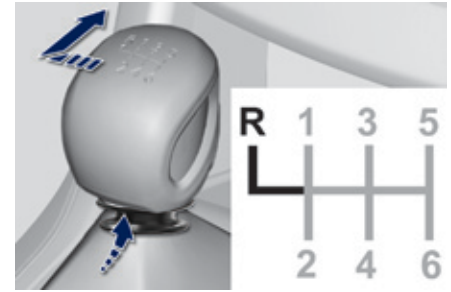

- ☞ Raise the ring under the knob and move the gear lever to the left then forwards.

! Only engage reverse gear when the vehicle is stationary with the engine at idle.

- i** As a safety precaution and to facilitate starting of the engine:
- always select neutral,
 - press the clutch pedal.

Gear shift indicator

System which reduces fuel consumption by advising the driver to change up.

Operation

Depending on the driving situation and your vehicle's equipment, the system may advise you to skip one (or more) gear(s). You can follow this instruction without engaging the intermediate gears.

The gear engagement recommendations must not be considered compulsory. In fact, the configuration of the road, the amount of traffic and safety remain determining factors when choosing the best gear. Therefore, the driver remains responsible for deciding whether or not to follow the advice given by the system.

This function cannot be deactivated.

Example:



- You are in third gear.



- You press the accelerator pedal.

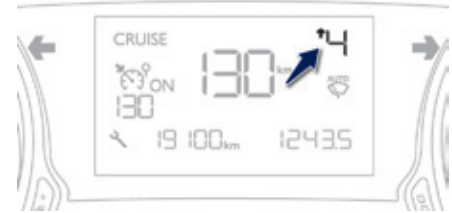

- The system may suggest that you engage a higher gear.

The information appears in the instrument panel in the form of an arrow.
On vehicles with manual gearbox, the arrow can be accompanied by the recommended gear.

- i** The system adapts its gear change recommendation according to the driving conditions (slope, load, ...) and the demands of the driver (power, acceleration, braking, ...).
The system never suggests:
- engaging first gear,
 - engaging reverse gear,
 - engaging a lower gear.

Automatic gearbox

Six speed automatic gearbox which offers a choice between the comfort of fully automatic operation, enhanced by sport and snow programmes, or manual gear changing.

Four driving modes are offered:

- **automatic** operation for electronic management of the gears by the gearbox,
- **sport** programme for a more dynamic style of driving,
- **snow** programme to improve driving when traction is poor,
- **manual** operation for sequential changing of the gears by the driver.

Gear lever



1. "S" (sport) programme switch.
2. "❄️" (snow) programme switch.

Gear selection gate

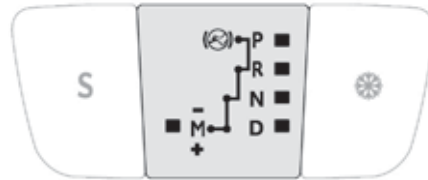

P. Park.

- Immobilisation of the vehicle, parking brake on or off.
- Starting the engine.

R. Reverse.

- Reversing manoeuvres, vehicle stationary, engine at idle.

N. Neutral.

- Immobilisation of the vehicle, parking brake on.
- Starting the engine.

D. Automatic operation.

M.+ / - Manual operation

Sequential changing of the six gears.

- ☞ Pull backwards to change up through the gears.

or

- ☞ Push forwards to change down through the gears.

Steering mounted controls



Pull on the **right hand** steering mounted control paddle to change up.

Pull on the **left hand** steering mounted control paddle to change down.

i The steering mounted control paddles cannot be used to select neutral or to select or come out of reverse.

Displays in the instrument panel

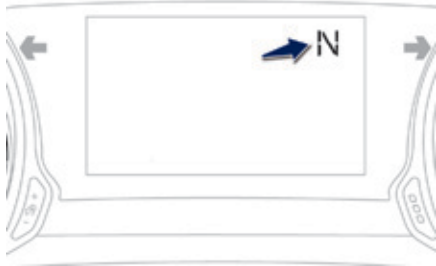

When you move the lever in the gate to select a position, the corresponding symbol appears in the instrument panel.

- P.** Park
- R.** Reverse
- N.** Neutral
- D.** Drive (Automatic driving)
- S.** Sport programme
- *** Snow programme
- 1 to 6.** Gear engaged during manual operation
- .** Invalid value during manual operation

Moving off

- ☞ With your foot on the brake, select position **P** or **N**.
- ☞ Start the engine.

If this procedure is not followed, an audible signal is heard, accompanied by a message in the instrument panel screen.

- ☞ With the engine running, press the brake pedal.
- ☞ Release the parking brake, unless it is programmed to automatic mode.
- ☞ Select position **R**, **D** or **M**,
- ☞ Gradually release the brake pedal.

The vehicle moves off.

- i** If position **N** is engaged inadvertently while driving, allow the engine to return to idle then engage position **D** to accelerate.

- !** When the engine is running at idle, with the brakes released, if position **R**, **D** or **M** is selected, the vehicle moves even without the accelerator being pressed. When the engine is running, never leave children in the vehicle without supervision. When carrying out maintenance with the engine running, apply the parking brake and select position **P**.

Automatic operation

☞ Select position **D** for **automatic** changing of the six gears.

The gearbox then operates in auto-adaptive mode, without any intervention on the part of the driver. It continuously selects the most suitable gear according to the style of driving, the profile of the road and the load in the vehicle.

For maximum acceleration without touching the lever, press the accelerator pedal down fully (kick down). The gearbox changes down automatically or maintains the gear selected until the maximum engine speed is reached. On braking, the gearbox changes down automatically to provide efficient engine braking.

If you release the accelerator sharply, the gearbox will not change to a higher gear for safety reasons.



Never select position **N** while the vehicle is moving.

Never select positions **P** or **R** unless the vehicle is completely stationary.

Sport and snow programmes

These two special programmes supplement the automatic operation in very specific conditions of use.

Sport "S"

☞ Press the "**S**" switch, after starting the engine.

The gearbox automatically favours a dynamic style of driving.



S appears in the instrument panel.

If you vehicle is equipped with the "Dynamic function", refer to the section covering this, which is part of sport mode.

Snow "❄"

☞ Press the "❄" switch, after starting the engine.

The gearbox adapts to driving on slippery roads.

This programme improves starting and drive when traction is poor.



❄ appears in the instrument panel.

Return to automatic operation

☞ At any time, press the button selected (**S** or "❄") again at any time to quit the programme engaged and return to auto-adaptive mode.

Creep function (moving without using the accelerator)

This function provides great flexibility in manoeuvring the vehicle at low speed (when parking, in traffic jams, ...).

With the engine at idle, parking brake released and position **D**, **M** or **R** selected, the **vehicle moves** as soon as you take your foot off the brake pedal (even without pressing the accelerator).

For your safety, this function will be activated only if you press the brake pedal when changing from forward drive to reverse.

It is deactivated on opening the driver's door. Closing the door then pressing the brake or accelerator pedal, reactivates the function.



Never leave children inside the vehicle without supervision when the engine is running.

Manual operation

- ☞ Select position **M** for **sequential** changing of the six gears.
- ☞ Pull the lever towards the **+** sign to change up a gear.
- ☞ Push the lever towards the **-** sign to change down a gear.

It is only possible to change from one gear to another if the vehicle speed and engine speed permit; otherwise, the gearbox will operate temporarily in automatic mode.



D disappears and the gears engaged appear in succession in the instrument panel.

If the engine speed is too low or too high, the gear selected flashes for a few seconds, then the actual gear engaged is displayed.

It is possible to change from position **D** (automatic) to position **M** (manual) at any time. When the vehicle is stationary or moving very slowly, the gearbox selects gear **M1** automatically.

The sport and snow programmes do not operate in manual mode.

Invalid value during manual operation



This symbol is displayed if a gear is not engaged correctly (selector between two positions).

Stopping the vehicle

Before switching off the engine, you can engage position **P** or **N** to place the gearbox in neutral.

In both cases, apply the parking brake to immobilise the vehicle, unless it is programmed to automatic mode.

- i** If the lever is not in position **P**, when the driver's door is opened or approximately 45 seconds after the ignition is switched off, there is an audible signal and a message appears.

- ☞ Return the lever to position **P**; the audible signal stops and the message disappears.

Operating fault

SERVICE

When the ignition is on, a message appears in the instrument panel screen to indicate a gearbox fault.

In this case, the gearbox switches to back-up mode and is locked in 3rd gear. You may feel a substantial knock when changing from **P** to **R** and from **N** to **R**. This will not cause any damage to the gearbox. Do not exceed 60 mph (100 km/h), local speed restrictions permitting.

Have it checked by a PEUGEOT dealer or a qualified workshop.



You risk damaging the gearbox:

- if you press the accelerator and brake pedals at the same time,
- if you force the lever from position **P** to another position when the battery is flat.



To reduce fuel consumption when stationary for long periods with the engine running (traffic jam...), position the gear lever at **N** and apply the parking brake, unless it is programmed in automatic mode.

Dynamic function

In sport mode (with an automatic gearbox), this function conditions:

- the visual ambience, with specific back-lighting for the instrument panel,
- the acoustic ambience of the engine,
- power assistance for the steering, acceleration,
- the automatic gearbox,
- information to the driver in the instrument panel on dynamic settings.

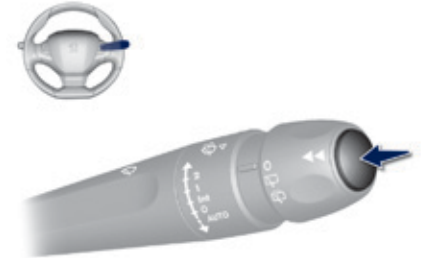

i This function is only available when Park Assist is not selected and snow mode in the automatic gearbox is not selected.

If Park Assist is switched on, this automatically deactivates the function.

Activation

- ☞ Press and hold the button until the back-lighting in the instrument panel changes. The LED in the button stays on.

i If the LED flashes, activation is not possible (for example if Park Assist or snow mode is selected) and so the back-lighting returns to its normal mode. If the LED continues flashing for a long time, contact a PEUGEOT dealer or a qualified workshop.

i The telemetry data (longitudinal and lateral acceleration, power produced, turbocharger pressure, ...) are given as an indication only.

Display

- ☞ Press the end of the wiper control stalk to display in the instrument panel the different information on dynamic settings.

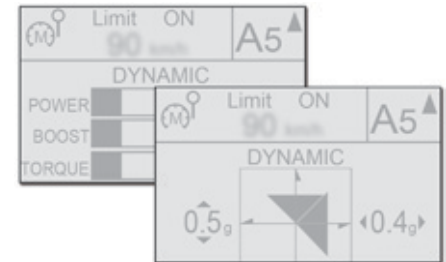

- ☞ Press repeatedly to go from one screen to another.

Stop & Start

The Stop & Start system puts the engine temporarily into standby - STOP mode - during stops in the traffic (red lights, traffic jams, or other...). The engine restarts automatically - START mode - as soon as you want to move off. The restart takes place instantly, quickly and silently. Perfect for urban use, the Stop & Start system reduces fuel consumption and exhaust emissions as well as the noise level when stationary.

Operation

Going into engine STOP mode



The "ECO" warning lamp comes on in the instrument panel and the engine goes into standby automatically:

- **With a manual gearbox**, at speeds below 12 mph (20 km/h) or vehicle stationary (depending on the engine), when you place the gear lever in neutral, and you release the clutch pedal.
- **With an automatic gearbox**, vehicle stationary, when you press the brake pedal or place the gear selector lever in position **N**.

Stop & Start time counter

(minutes / seconds or hours / minutes)



If your vehicle is fitted with Stop & Start, a time counter calculates the time spent in STOP mode during a journey.

It resets to zero every time the ignition is switched on.



For your comfort, during parking manoeuvres, STOP mode is not available for a few seconds after coming out of reverse gear. STOP mode does not affect the functionality of the vehicle, such as for example, braking, power steering...



Never refuel with the engine in STOP mode; you must switch off the ignition with the button.

Special cases: STOP mode not available

STOP mode is not invoked principally when:

- the vehicle is on a steep slope (up or down),
- the driver's door is open,
- the driver's seat belt is not fastened,
- the vehicle has not exceeded 6 mph (10 km/h) since the last engine start by the driver,
- the electric parking brake is applied or being applied,
- the engine is needed to maintain a comfortable temperature in the passenger compartment,
- demisting is active,
- some special conditions (battery charge, engine temperature, braking assistance, ambient temperature...) where the engine is needed to assure control of a system.



In this case, the "ECO" warning lamp flashes for a few seconds then goes off.

This operation is perfectly normal.

Going into engine START mode

ECO The "ECO" warning lamp goes off and the engine starts automatically:

- **With a manual gearbox**, when you **fully** depress the clutch pedal.
- **With an automatic gearbox**:
 - gear selector in position **D** or **M**, when you release the brake pedal,
 - or gear selector in position **N** and brake pedal released, when you place the gear selector in position **D** or **M**,
 - or when you engage reverse.

Special cases: START invoked automatically

START mode is invoked automatically when:

- you open the driver's door,
- you unfasten the driver's seat belt,
- the speed of the vehicle exceeds 15 mph (25 km/h) or 2 mph (3 km/h) (depending on the engine) with a manual gearbox,
- the speed of the vehicle exceeds 2 mph (3 km/h) with an automatic gearbox,
- the electric parking brake is being applied,
- some special conditions (battery charge, engine temperature, braking assistance, ambient temperature...) where the engine is needed for control of a system.

ECO In this case the "ECO" warning lamp flashes for a few seconds, then goes off.

This operation is perfectly normal.

Deactivation



At any time, press the "ECO OFF" switch to deactivate the system. This is confirmed by the switch warning lamp coming on accompanied by a message.

! If the system has been deactivated in STOP mode, the engine restarts immediately.

Reactivation

Press the **"ECO OFF"** switch again.
The system is active again; this is confirmed by the switch warning lamp going off, accompanied by a message.

i The system is reactivated automatically at every new engine start by the driver.

Operating fault



In the event of a fault with the system, this warning lamp comes on continuously.
Have it checked by a PEUGEOT dealer or a qualified workshop.

In the event of a fault in STOP mode, the vehicle may stall.

All of the instrument panel warning lamps come on.

Depending on version, an alert message may also be displayed, asking you to place the gear lever in position **N** and put your foot on the brake pedal.

You must switch off the ignition, then start the engine again.

Maintenance

! Before doing anything under the bonnet, deactivate the Stop & Start system to avoid any risk of injury resulting from automatic operation of START mode.

This system requires a 12 V battery with a special specification and technology (reference numbers available from PEUGEOT dealers).
Fitting a battery not listed by PEUGEOT introduces the risk of malfunction of the system.

For charging, use a 12 V charger and do not reverse the polarity.

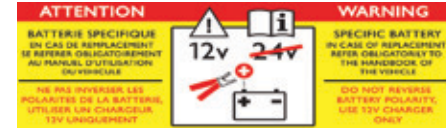

! The Stop & Start system makes use of advanced technology. For any work on the system go to a qualified workshop with the skills and equipment required, which a PEUGEOT dealer is able to provide.

Memorising speeds

Touch screen

This function allows speeds to be saved, which can then be offered to set the two systems: the speed limiter (to limit the speed of the vehicle) or the cruise control (for a vehicle cruising speed).

You can memorise up to six speed settings for each of the two systems. By default, some speeds are already memorised.

Memorisation

☞ Go to the "Driving assistance" menu.



☞ Select the "Speed settings".



☞ Select the system for which you want to memorise speeds:



- speed limiter or



- cruise control.

☞ Choose the speed setting you want to modify.



☞ Enter the new value using the numerical keypad and confirm.

☞ Confirm to save the modification and quit the menu.



This button allows you return to the factory settings.

! For safety reasons, the driver must carry out these operations when stationary.

Speed limiter

Once the programmed speed limit is reached, additional pressure on the accelerator pedal has no effect.

System which prevents the vehicle from exceeding the speed programmed by the driver.

The speed limiter is **switched on** manually: it requires a programmed speed of at least 20 mph (30 km/h).

The speed limiter is **paused** by operation of the control.

The programmed speed can be exceeded temporarily by pressing the accelerator firmly beyond the point of resistance.

To return to the programmed speed, simply release the accelerator pedal until the vehicle returns to the programmed speed limit.

i The programmed speed remains in the memory when the ignition is switched off.

! The speed limiter cannot, in any circumstances, replace the need to observe speed limits, nor can it replace the need for vigilance and responsibility on the part of the driver.

Steering mounted controls

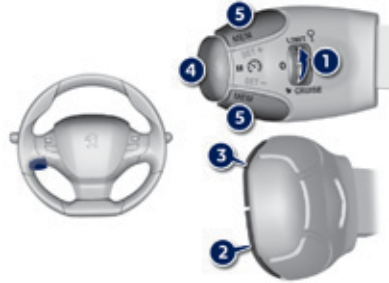

The controls are grouped together at the steering wheel.

1. Speed limiter mode selection wheel.
2. Value decrease button.
3. Value increase button.
4. Speed limiter on / pause button.
5. List of memorised speeds display button.

! For more information on the list of memorised speeds, refer to the "Memorising speeds" section.

Displays in the instrument panel

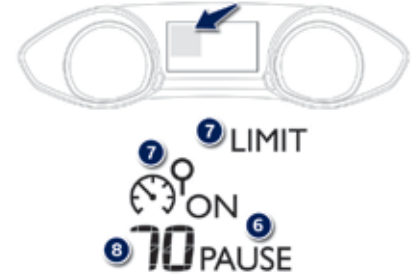

The information is grouped together in the instrument panel.

6. Speed limiter on / pause indication.
7. Speed limiter mode selection indication.
8. Speed value setting.

4

Switching on / Pause



- ☞ Turn wheel **1** to the **"LIMIT"** position: the speed limiter mode is selected but is not switched on (Pause).
- ☞ Switch the speed limiter back on by pressing button **4**, if the speed displayed is suitable (by default, the last speed programmed).
- ☞ You can temporarily stop the the speed limiter by pressing button **4** again: the display confirms that it has been stopped (Pause).

Adjusting the speed limit setting



- You do not have to switch the speed limiter on in order to set the speed.
- Once the function is selected, you can modify the speed setting by:
- using buttons **2** and **3**, increasing or decreasing the speed displayed:
 - ☞ by successive short presses, to modify by + or - ½ mph (1 km/h),
 - ☞ by a maintained press, to modify in steps of + or - 3 mph (5 km/h).

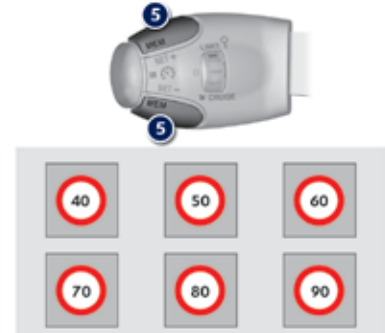

- a press on button **5**:
 - ☞ the six speeds memorised, displayed in the touch screen,
 - ☞ choosing a speed: it is displayed in the instrument panel.
- The selection screen closes after a few moments.

Temporarily exceeding the programmed speed

☞ Press **firmly** on the accelerator pedal, going beyond the **point of resistance**, to exceed the programmed speed limit.

The speed limiter is deactivated temporarily and the displayed programmed speed flashes. An audible signal accompanies the flashing of the programmed speed when exceeding the speed is not due to an action by the driver (steep hill...).

As soon as the vehicle's speed returns to the programmed value, the limiter operates again: the display of the programmed speed becomes steady again.

Switching off

☞ Turn wheel **1** to the **"0"** position. The display of information related to the speed limiter disappears.

Operating fault

Flashing of the dashes indicates a fault with the speed limiter.

Have it checked by a PEUGEOT dealer or a qualified workshop.



On sharp acceleration, as when descending a steep hill, the speed limiter will not be able to prevent the vehicle from exceeding the programmed speed.

The limiter is temporarily deactivated and the displayed programmed speed flashes.

An audible signal accompanies the flashing of the programmed speed when exceeding the speed is not due to an action by the driver.

The use of mats not approved by PEUGEOT may interfere with the operation of the speed limiter.

To avoid any risk of jamming of the pedals:

- ensure that the mat is positioned correctly,
- do not fit one mat on top of another.

Cruise control

System which automatically maintains the speed of the vehicle at the value programmed by the driver, without any action on the accelerator pedal.

The cruise control is **switched on** manually: it requires a minimum vehicle speed of 25 mph (40 km/h).

As well as the engagement of at least third or fourth gear (depending on engine) on a manual gearbox.

As well as the engagement of at least second gear (depending on engine) on an automatic gearbox.

The cruise control is **paused** manually or by pressing the brake or clutch pedal or on triggering of the ESC system for safety reasons.

It is possible to exceed the programmed speed temporarily by pressing the accelerator pedal. To return to the programmed speed, simply release the accelerator pedal until the programmed cruise speed is reached again.

i Switching off the ignition cancels any programmed speed value.

! The cruise control system cannot, in any circumstances, replace the need to observe speed limits, nor can it replace the need for vigilance and responsibility on the part of the driver. You are advised to keep your feet near the pedals at all times.

Steering mounted controls



The controls of this system are grouped together at the steering wheel.

1. Cruise control mode selection wheel.
2. Decrease value or speed setting on the fly button.
3. Increase value or speed setting on the fly button.
4. Cruise control pause / resume button.
5. Memorised speeds display button.

i For more information on the list of memorised speeds, refer to the "Memorising speeds" section.

Displays in the instrument panel



The information is grouped together in the instrument panel.

6. Cruise control pause / resume indication.
7. Cruise control mode selection indication.
8. Speed value setting.

Switching on



- ☞ Turn wheel **1** to the **"CRUISE"** position: the cruise control mode is selected but is not switched on (Pause).
 - ☞ Press button **2** or **3**: your vehicle's current speed becomes the cruise speed (selected on the fly).
- The cruise control is activated (ON).

Modification of the initial speed setting



- If the cruise control is switched on, you can then modify the initial speed in one of the following ways:
- using buttons **2** or **3**:
 - ☞ by successive short presses, to modify the speed by + or - 1 mph (km/h),
 - ☞ by a long press, to modify the speed in steps of + or - 5 mph (km/h),

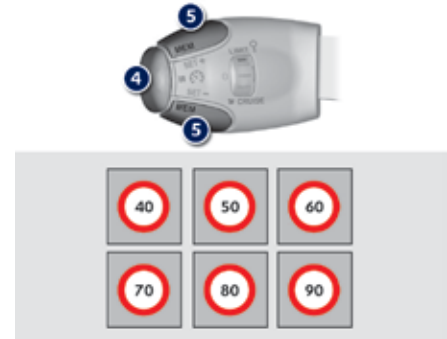

- pressing button **5**:
 - ☞ the six memorised speeds are displayed in the touch screen,
 - ☞ choose a value: it is displayed in the instrument panel.

The selection screen closes after a few moments.

The modification is then accepted.

Pause

Once switched on, you can pause the cruise control at any time by pressing button **4**: the screen confirms the pause.

Exceeding the programmed speed

If the programmed speed is exceeded, the displayed speed flashes.

Once the vehicle returns to the programmed speed, the display becomes steady again.

Switching off

- ☞ Turn wheel 1 to the "0" position.
The display of information related to the cruise control disappears.

Operating fault

Flashing of the dashes indicates a fault with the cruise control.

Have it checked by a PEUGEOT dealer or a qualified workshop.



- ! When the cruise control is switched on, be careful if you maintain the pressure on one of the programmed speed changing buttons: this may result in a very rapid change in the speed of your vehicle.
Do not use the cruise control on slippery roads or in heavy traffic.
On a steep descent, the cruise control will not be able to prevent the vehicle from exceeding the programmed speed.
On steep climbs or when towing, the programmed speed may not be reached or maintained.
The use of mats not approved by PEUGEOT may interfere with the operation of the cruise control.
To avoid any risk of jamming of the pedals:
 - ensure that the mat is positioned correctly,
 - never fit one mat on top of another.

Active cruise control

This system allows the vehicle's speed to be maintained at a value set by the driver.

In addition it allows (when circumstances permit) an inter-vehicle time that you have selected (around 2 seconds by default and at each activation of the system) to be maintained.

Principles of operation

Using a radar with a range of about 100 metres, located at the front of the vehicle, this system detects a vehicle running in front of your vehicle.

It automatically adapts the speed of your vehicle to that of the vehicle in front.

If the vehicle in front is running more slowly, the system progressively reduces the speed of your vehicle using just engine braking (as if the driver had pressed the "-" button).

If your vehicle is too close to, or approaching too quickly the vehicle in front, the cruise control is automatically deactivated. The driver is then alerted by an audible signal, accompanied by a message.

If the vehicle in front accelerates or changes lane, the active cruise control progressively accelerates your vehicle to return to the programmed speed.

If the driver operates a direction indicator to overtake a slower vehicle, the active cruise control allows your vehicle to temporarily approach the vehicle in front to assist the overtaking manoeuvre, though never exceeding the programmed speed.

i The active cruise control operates by day and at night, in fog or moderate rainfall.

i The activation of this system deactivates the display of inter-vehicle time.

! The system does not act on the braking system, but works only with engine braking.
The regulation range is limited: there will no longer be any adjustment of speed if the difference between the programmed speed setting and the speed of the vehicle in front becomes too high.

! If the difference between the programmed speed setting and the speed of the vehicle in front is too great, the speed cannot be adjusted: the cruise control is automatically deactivated.

4

General points

The active cruise control is **switched on** manually, it requires that the speed of the vehicle be between 25 mph (40 km/h) and 90 mph (150 km/h).

As well as the engagement of at least third or fourth gear (depending on engine) on a manual gearbox.

As well as the engagement of at least second gear (depending on engine) on an automatic gearbox.

If the cruise speed setting is above 90 mph (150 km/h), the active cruise control switches to normal cruise control mode (without automatic adjustment of the safety inter-vehicle distance).

The active cruise control can be **paused** manually with the control, or automatically:

- by pressing the brake or clutch pedal,
- in the event of operation of the ESP, for safety reasons,
- in the event of an action of the electric parking brake control,
- when an inter-vehicle time threshold is reached (calculated according to the relative speeds of your vehicle and the vehicle in front and the inter-vehicle time setting chosen),
- when the distance between your vehicle and the one in front becomes too small,
- when the speed of the vehicle in front is too low,
- when the speed of your vehicle becomes too low.

! The active cruise control cannot in any circumstances replace the observation of speed limits, nor the the vigilance and responsibility of the driver. It is recommended that you always keep your feet close to the pedals.

i Switching off the ignition cancels any programmed value, and the inter-vehicle time is reset to 2 seconds.

Steering mounted controls



The controls for this system are grouped together on the steering wheel.

1. Cruise control mode selection wheel.
2. Button for reducing the cruise value setting or for setting the cruise value on the fly.
3. Button for increasing the cruise value setting or for setting the cruise value on the fly.
4. Button for pausing / resuming the cruise control.
5. Button for displaying the list of memorised speeds and for adjusting the inter-vehicle time.

i For more information on the list of memorised speeds, refer to the "Memorising speeds" section.

Displays in the instrument panel



The information is grouped together in the instrument panel.

6. Indication of cruise control pause/resume.
7. Indication of selection of cruise control mode, or vehicle speed adjustment phase.
8. Cruise speed setting.

Switching on



4

- ☞ Turn the wheel **1** to the "**CRUISE**" position: cruise control mode is selected, but not started (Pause).
- ☞ Press one of the buttons **2** or **3**: the current speed of your vehicle becomes the cruise speed setting (set on the fly). The cruise control is activated (ON). The inter-vehicle time is set at 2 seconds.

Modification of the cruise control speed only

Buttons 2 (SET+) and 3 (SET-)

If the cruise control is on, you can modify the speed:

- ☞ by successive short presses, to modify by steps of + or - 1 mph (km/h),
- ☞ by a maintained press, to modify in steps of + or - 5 mph (km/h).

As a precaution, it is recommended that you select a cruise speed setting close to the current speed of your vehicle.

Modification of the cruise control speed and/or the inter-vehicle time

Button 5 (MEM)

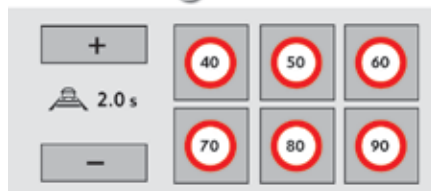

Press button 5, the six memorised speeds and the inter-vehicle time setting are displayed in the touch screen.

- ☞ Choose a speed setting: it is displayed in the instrument panel,
- ☞ press or the "+" or "-" button to choose a new inter-vehicle time setting between 2.5 seconds and 1 second.

The selection screen closes after a few moments. The modifications are then accepted.

i In the event of the presence of a vehicle detected by the radar, if the speed selected is much higher than the speed of that vehicle, the system is not activated and the alert message "Activation not possible, conditions unsuitable" is displayed until driving conditions are safe to allow activation of the system.

Exceeding the programmed speed





It is possible to exceed the programmed speed temporarily by depressing the accelerator pedal. Simply release the accelerator pedal to return to the programmed speed.





If the programmed speed is unintentionally exceeded, descending a steep hill for example, the speed setting in the instrument panel flashes as a warning.

Driving situations and associated alerts

The following table describes the alerts and the messages displayed for the different driving situations.

The display of these alerts is not sequential.

Symbol	Display in the instrument panel	Associated message	Comments
			No vehicle detected: the system operates as a conventional cruise control.
			Detection of a vehicle, at the limit of the range of the radar: the system operates as a conventional cruise control.

Symbol	Display in the instrument panel	Associated message	Comments
		"SPEED ADJUSTED"	<p>Detection of a vehicle that is too close or running at a speed lower than your vehicle's cruise speed setting.</p> <p>The system uses engine braking to slow your vehicle (within a limit of 20 mph (30 km/h)) and then hold it at the speed of the vehicle in front so as to observe the programmed inter-vehicle time.</p> <p>When automatically slowing down behind a vehicle, your true speed may be higher than the "adjusted speed" displayed.</p>
		"Cruise control paused".	<p>If the system exceeds the limit of speed adjustment possible by the system and in the absence of any reaction by the driver (operation of the direction indicator, change of lane, reduction of the speed of the vehicle), the system is automatically paused.</p> <p>The display of the deactivation message is accompanied by an audible signal.</p>

! When the active cruise control is automatically paused, it can only be reactivated when safe conditions are restored. The message "Activation not possible, conditions unsuitable" is displayed while reactivation is not possible. When the conditions allow, it is recommended that the function be reactivated by pressing button **2** (SET+) or **3** (SET-), which will make the current speed of your vehicle the new cruise speed setting, rather than by pressing button **4** (on/pause) which reactivates the cruise control using the old cruise speed setting, which may be very different from the current speed of your vehicle.

Limits of operation

The speed regulation range is limited to a maximum difference of 20 mph (30 km/h) between the speed setting and the speed of the vehicle in front.

Above this, the system goes into pause if the safe distance becomes too low.

The active cruise control uses only engine braking to slow the vehicle. Consequently the vehicle loses speed slowly, as when releasing the accelerator pedal.

The system is paused automatically:

- if the vehicle in front slows down to much or too suddenly, and the driver does not brake,
- if a vehicle comes between your vehicle and the vehicle in front,
- if the system does not slow the vehicle enough to continue to maintain a safe distance, for example when descending a steep hill.

As the radar's field of view is quite narrow, it is possible that the system may not detect:



- vehicles of reduced width, such as motorcycles, for example,



- vehicles not running in the middle of the lane,



- vehicles entering a corner,
- vehicles changing lane at the last moment.

The cruise control does not take account of:

- stationary vehicles,
- vehicles driving in the opposite direction.

Operating fault

In the event of a fault with the active cruise control, you are alerted by an audible signal and display of the message message "Driving aid functions fault".

Have the system checked by a PEUGEOT dealer or a qualified workshop.

The use of mats not approved by PEUGEOT may interfere with the operation of the active cruise control.

To avoid any risk of jamming the pedals:

- ensure that mats are positioned correctly,
- never fit one mat on top of another.



i The operation of the radar, located in the front bumper, may be disturbed in certain weather conditions, for example: with accumulations of snow, ice, mud, ...
Clean the front bumper, removing the snow, mud, ...

! When the cruise control is working, take care if making a maintained press on one of the cruise control programmed speed modification buttons: this can lead to a very quick change in the speed of your vehicle.
Do not use the active cruise control on slippery surfaces or in heavy traffic. When descending a steep hill, the cruise control may not be able to prevent the vehicle from exceeding the programmed speed.
When ascending a steep hill or when towing, it might not be possible to attain or maintain the programmed speed.

Display of inter-vehicle time

Using a radar located at the front of the vehicle, this system helps the driver maintain a safe distance between their vehicle and the one in front, by displaying the inter-vehicle time in the instrument panel.

It is the time interval, expressed in seconds, that separates two vehicles in line. The recommended safe value is about 2 seconds: refer to the legislation or highway code in force in your country.

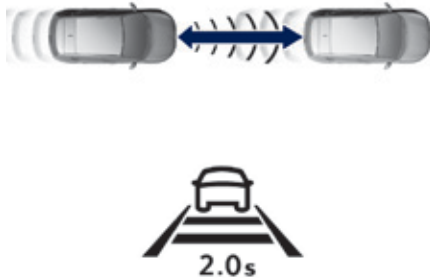

- i** The system is active in a speed range between 42 and 93 mph (70 and 150 km/h). Stationary vehicles and certain other road users (such as bicycles for example) are not detected. The system displays inter-vehicle time values of between 3 seconds and 0.5 of a second. Below 0.5 of a second, the value displayed is maintained at this level, even if the true inter-vehicle time is less.

- !** The measurement is displayed for information only: the system takes no action on the vehicle. This system does not in any circumstances replace the vigilance and responsibility of the driver who must remain in control of their vehicle at all times. The system is not designed for urban use nor during more dynamic driving (bends, acceleration, harsh braking...) but rather when driving at stable speed.

Activation / deactivation

Activation of the system is done in the "**Driving assistance**" menu, with the engine running.



- ☞ Press this button, the indicator lamp comes on.



The state of the system is memorised when the ignition is switched off.



- i** Activation of the active cruise control automatically deactivates the system.

4

Displays

Once the system has been activated and the speed conditions are met, a symbol is displayed in the instrument panel.

Symbol	Associated message	Comments
		No vehicle detected by the radar.
		A vehicle is detected but the inter-vehicle time is more than 3 seconds. No value is displayed.
		A vehicle is detected. The inter-vehicle time is 3 seconds or less. The minimum value displayed is 0.5 seconds, even if the true inter-vehicle time is lower.

Symbol	Associated message	Comments
	<p>"SYSTEM INACTIVE: Speed unsuitable"</p>	<p>If the speed of your vehicle is outside the operating range. Where the speed is not suitable, a message is displayed while the speed is outside limits (below 42 mph (70 km/h) or above 93 mph (150 km/h), approximately). However, when decelerating, the system is deactivated below 27 mph (45 km/h).</p>
	<p>"System deactivated"</p>	<p>On deactivating the function, in "DRIVING" display mode.</p>
	<p>"SYSTEM INACTIVE: Visibility reduced"</p>	<p>The system switches to standby automatically if the sensor does not detect the vehicle in front correctly (very difficult weather conditions, sensor out of adjustment, ...).</p>

Operating limits

The vehicle being followed may not be detected in certain conditions such as, for example:

- when turning,
- when changing lane,
- when the vehicle in front is out of the range of the sensor (maximum range: around 100 m).

Operating fault

SERVICE In the event of a fault with the system, this warning lamp is displayed accompanied by a message.

Have the system checked by a PEUGEOT dealer or a qualified workshop.

i At the first use of the system after repair, a message may be displayed indicating that the system is initialising. The system is not available while this is in progress. As soon as the message disappears the system is operational again. If the message does not disappear, contact a PEUGEOT dealer or a qualified workshop.



i The operation of the radar, located in the front bumper, may be disturbed in certain weather conditions, for example: with accumulations of snow, ice, mud, ...
Clean the front bumper, removing the snow, mud, ...

Emergency collision alert system and emergency collision braking system

Emergency collision alert

System providing a warning to the driver that their vehicle is at risk of collision with the vehicle in front.



i This system operates from 20 mph (30 km/h), only when other vehicles are running in the same direction as your vehicle; the system does not detect stationary objects. A radar is fitted at the front of the vehicle.

! This system has been designed to improve driving safety. The driver must constantly monitor the traffic conditions, to assess the distance and relative speed of other vehicles. The collision risk alert system can never replace the vigilance and responsibility of the driver.

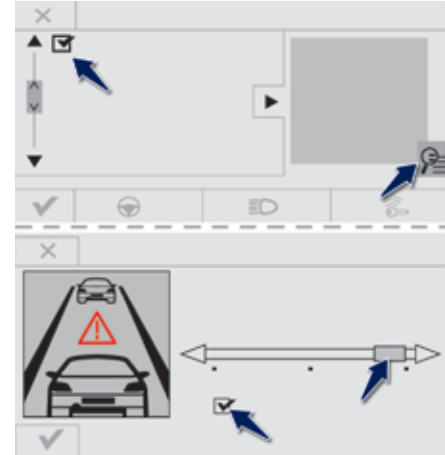

4

The emergency collision alert system can be activated or deactivated by the driver. From the secondary page of the "**Driving assistance**" menu:

- ☞ Select the "**Vehicle settings**" menu.
- ☞ Check the "**Collision risk alert and auto braking**" line and confirm.

Setting the thresholds for the alert

The alert thresholds determine how you want to be alerted to the presence of a vehicle running in front of you.

You can choose from three thresholds:

- 1: "Distant", to be given an early alert (cautious driving).
- 2: "Normal".
- 3: "Close", to be given a later alert (sporty driving).



From the secondary page of the "**Driving assistance**" menu:

- ☞ Select the "**Vehicle settings**" menu.
- ☞ Check the "**Collision risk alert and auto braking**" line.



- ☞ Press on the magnifying glass.

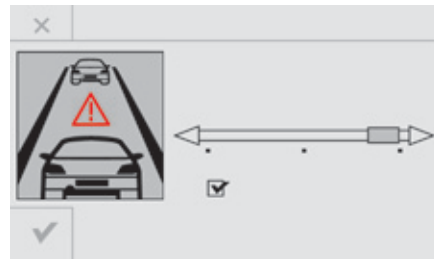

- ☞ Modify the alert threshold and press on "**Finish**" to memorise the threshold and leave the menu.
- ☞ Press on "**Confirm**" to save the change.

Alerts

According to the collision risk detected by the system and the alert threshold chosen, different levels of alert can be given.



Level 1: visual alert only (orange) indicating that the vehicle in front is very close. The message "**Vehicle close**" is displayed.

This level of alert is based on the inter-vehicle time between your vehicle and the one in front.



Level 2: visual (red) and audible alerts indicating that a collision is imminent. The message "**Brake!**" is displayed.

This level of alert is based on a time before collision. It takes account of the vehicle dynamics, the speed of your vehicle and the speed of the vehicle in front, the driving conditions, the situation with your vehicle (cornering, pedals pressed, etc.) to trigger the alert at the right moment.



The emergency collision alert system does not replace the vigilance and responsibility of the driver.



The change from one level of alert to the next takes place if the driving conditions do not change (speed unchanged, no change of lane...)



If the speed of your vehicle is too high when approaching another vehicle, the first level of alert may not be displayed: the level 2 alert may be displayed directly.

On the other hand, the level 1 alert is never displayed with the "close" triggering threshold 3.

Severe weather conditions (very heavy rain, accumulations of snow in front of the radar) may interfere with the operation of the system, resulting in the display of this message "**SYSTEM INACTIVE: Reduced visibility**". The system will remain unavailable until the message disappears.

Emergency automatic braking system

Emergency automatic braking is a system that aims to reduce the speed of a frontal collision if the driver does not take action, using radar type detection and acting on the vehicle's braking system.

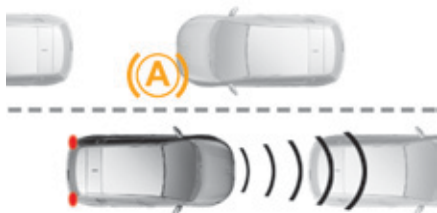

Conditions for activation

Emergency automatic braking only operates in the following conditions:

- engine running
- no fault in the electronic stability system,
- speed at least 12 mph (20 km/h),
- engine speed sufficiently high,
- not in a tight corner.



From the secondary page of the "**Driving assistance**" menu:

- ☞ Select the "**Vehicle settings**" menu.
- ☞ Check the "**Collision risk alert and auto braking**" line.



☞ Press the magnifying glass.

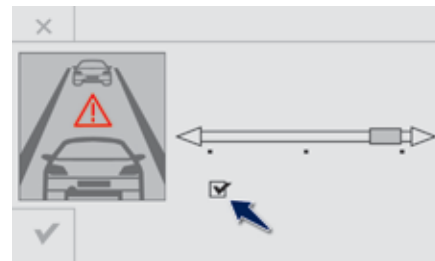

- ☞ Modify the alert threshold and check the "**Auto braking**" line.
- ☞ Press on "**Finish**" to memorise the threshold and leave the menu.
- ☞ Press on "**Confirm**" to save the change.



This warning lamp flashes when your vehicle "starts" to brake but will not in any circumstance completely stop the vehicle.



You should continue to press firmly on the brake pedal until the vehicle comes to a complete stop.



When the emergency collision braking system is not activated, this warning lamp is on fixed.

Operating fault

SERVICE

In the event of a fault, you are alerted by the display of the Service warning lamp, accompanied by a message.
Consult a PEUGEOT dealer or a qualified workshop.



- i The operation of the radar, located in the front bumper, may be disturbed in certain weather conditions, for example: with accumulations of snow, ice, mud, ...
Clean the front bumper, removing the snow, mud, ...

Blind spot sensors



This driving assistance system warns the driver of the presence of another vehicle in the blind spot angle of their vehicle (areas masked from the driver's field of vision), as soon as this presents a potential danger.



A warning lamp appears in the door mirror on the side in question:

- immediately, when being overtaken,
- after a delay of about one second, when overtaking a vehicle slowly.

Operation



Activation of the system is done in the "**Driving assistance**" menu of the touch screen.



Press this button to activate the function; the associated indicator lamp comes on.

This indicator lamp comes on in the instrument panel.

Sensors fitted in the front and rear bumpers monitor the blind spots.



This system is designed to improve safety when driving and is in no circumstances a substitute for the use of the interior rear view mirror and door mirrors. It is the driver's responsibility to constantly check the traffic, to assess the distances and relative speeds of other vehicles and to predict their movements before deciding whether to change lane. The blind spot sensor system can never replace the vigilance and responsibility of the driver.

The alert is given by a warning lamp which comes on in the door mirror on the side in question as soon as a vehicle - car, lorry, bicycle - is detected and the following conditions are fulfilled:

- all the vehicles must be moving in the same direction,
- the speed of your vehicle is between 7 and 87 mph (12 and 140 km/h),
- the difference in speed between your vehicle and the other vehicles must be less than 6 mph (10 km/h),
- the traffic must be flowing normally, in the case of an overtaking manoeuvre, if this is prolonged and the vehicle being overtaken remains in the blind spot,
- you are driving on a straight or slightly curved road,
- your vehicle is not pulling a trailer, a caravan...

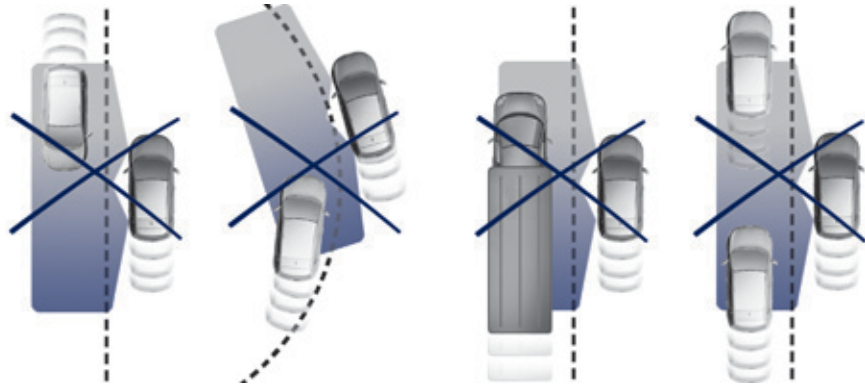

No alert will be given in the following situations:

- in the presence of stationary objects (parked vehicles, barriers, street lamps, road signs...),
- with vehicles moving in the opposite direction,
- driving on a sinuous road or a sharp corner,
- when overtaking (or being overtaken by) a very long vehicle (lorry, coach...) which is at the same time detected at the rear in the blind spot angle and present in the driver's forward field of vision,
- in very heavy traffic: vehicles detected in front and behind are confused with a lorry or a stationary object,
- when overtaking quickly.



To deactivate the system, press this button again; its indicator lamp goes off as well as the associated indicator in the instrument panel.

The state of the system remains in memory on switching off the ignition.

i The system is automatically deactivated when towing with a towbar approved by PEUGEOT.

Operating fault



In the event of a fault, the warning lamp flashes then goes off.

Have it checked by a PEUGEOT dealer or a qualified workshop.

i The system may suffer temporary interference in certain weather conditions (rain, hail...). In particular, driving on a wet surface or moving from a dry area to a wet area can cause false alerts (for example, the presence of a fog of water droplets in the blind spot angle is interpreted as a vehicle). In bad or wintry weather, ensure that the sensors are not covered by mud, ice or snow. Take care not to cover the warning zone in the door mirrors or the detection zones on the front and rear bumpers with adhesive labels or other objects; they may hamper the correct operation of the system.

! **High pressure jet wash**
When washing your vehicle, direct the lance at least 30 cm away from the sensors.

Parking sensors

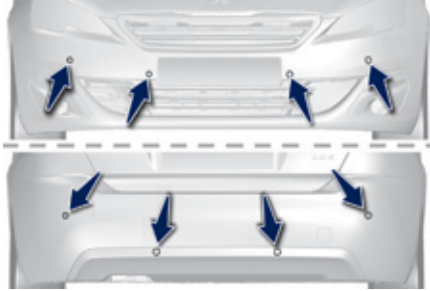

This system indicates the proximity of an obstacle (person, vehicle, tree, gate, etc.) which comes within the field of detection of sensors located in the bumper. Certain types of obstacle (stake, roadworks cone, etc.) detected initially will no longer be detected at the end of the manoeuvre due to the presence of blind spots.

! This function cannot, in any circumstances, take the place of the vigilance and responsibility of the driver.

Rear parking sensors

The system is switched on by engaging reverse gear. This is accompanied by an audible signal. The system is switched off when you come out of reverse gear.



Audible assistance

The proximity information is given by an intermittent audible signal, the frequency of which increases as the vehicle approaches the obstacle. The sound emitted by the speaker (right or left) indicates the side on which the obstacle is located. When the distance between the vehicle and the obstacle becomes less than approximately thirty centimetres, the audible signal becomes continuous.



Visual assistance

This supplements the audible signal by displaying bars in the screen or the instrument panel which move progressively nearer to the vehicle. When the obstacle is near, the "Danger" symbol is displayed.

4

Front parking sensors

In addition to the rear parking sensors, the front parking sensors are triggered when an obstacle is detected in front and the speed of the vehicle is still below 6 mph (10 km/h).

The front parking sensors are interrupted if the vehicle stops for more than three seconds in forward gear, if no further obstacles are detected or when the speed of the vehicle exceeds 6 mph (10 km/h).

i The sound from the speakers (front or rear) indicates whether the obstacle is in front or behind.

Deactivation / Activation of the front and rear parking sensors



The system is deactivated in the "Driving assistance" menu of the touch screen.



i Press this button. The indicator lamp in the button comes on.

Pressing this button again reactivates the function. The indicator lamp in the button goes off.

i The system will be deactivated automatically if a trailer is being towed or a bicycle carrier is fitted (vehicle fitted with a towbar or bicycle carrier recommended by PEUGEOT).

Operating fault

SERVICE

In the event of a malfunction of the system, when reverse gear is engaged this warning lamp is displayed in the instrument panel and/or a message appears, accompanied by an audible signal (short beep).

Contact a PEUGEOT dealer or a qualified workshop.

i In bad weather or in winter, ensure that the sensors are not covered with mud, ice or snow. When reverse gear is engaged, an audible signal (long beep) indicates that the sensors may be dirty. Certain sound sources (motorcycle, lorry, pneumatic drill, etc.) may trigger the audible signals of the parking sensor system.

Reversing camera



The reversing camera is activated automatically when reverse gear is engaged. Depending on version, the image is displayed in the touch screen or the instrument panel.

The reversing camera function may be completed with parking sensors.

- i** The reversing camera cannot in any circumstances be a substitute for the vigilance and responsibility of the driver.

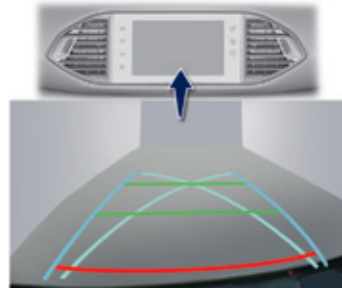

- i** The superimposed representation of guide lines helps with the manoeuvre. They are represented by lines marked "on the ground" and do not allow the position of the vehicle to be determined relative to tall obstacles (for example: other vehicles, ...).

The blue lines represent the general direction of the vehicle (the difference corresponds to the width of your vehicle without the mirrors).

The red lines represent a distance of about 30 cm beyond the edge of your vehicle's rear bumper.

The green lines represent distances of about 1 and 2 metres beyond the edge of your vehicle's rear bumper.

The turquoise blue curves represent the maximum turning circle.

Opening the tailgate causes the display to disappear.

- i** Clean the reversing camera regularly using a soft, dry cloth.

High pressure jet washing

When washing your vehicle, do not direct the lance within 30 cm of the camera lens.

Park Assist

This system provides active assistance with parking, detecting a parking space then controlling the steering to park in the space. It controls the steering while the driver manages the accelerator, brakes, gears and clutch (manual gearbox). During phases of entry into and exit from a parking space, the system provides visual and audible information to the driver in order to make the manoeuvres safe. It may be necessary to move forwards and backwards more than once.

The driver can take control at any time by gripping the steering wheel.

! The Park Assist system cannot in any circumstances replace the care and responsibility of the driver.

The driver must remain in control of their vehicle ensuring that the space remains clear throughout the manoeuvre.

In some circumstances, the sensors may not detect small obstacles located in their blind spots.

i The Park Assist system cannot work with the engine off.

The Park Assist system provides assistance for the following manoeuvres:

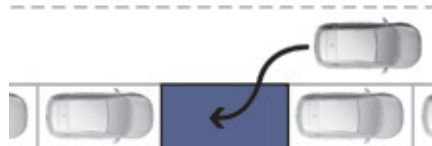

- entry into a parallel parking space

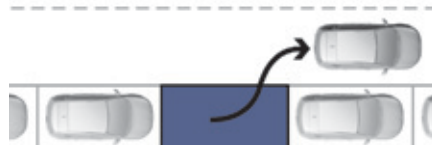

- exiting from a parallel parking space

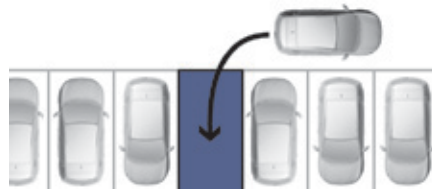

- bay parking

! During a manoeuvre the steering wheel turns quickly; do not hold the steering wheel, do not place your hand between the spokes of the steering wheel and take care with loose and bulky clothing, scarves, handbags... There is a risk of injury.

i When Park Assist is activated, it prevents a change to STOP mode of Stop & Start. In STOP mode, activation of Park Assist restarts the engine.

i The Park Assist system takes control of the power steering for a maximum of 4 manoeuvre cycles. The function is deactivated after these 4 cycles. If you think that your vehicle is not positioned correctly, you should then take control of the steering to carry out the manoeuvre.

! The sequence of manoeuvres and the driving instructions are displayed in the instrument panel.



The assistance is activated: the display of this symbol and a speed limit indicate that the steering manoeuvres are controlled by the system: do not touch the steering wheel.



The assistance is deactivated: the display of this symbol indicates that the steering manoeuvres are no longer controlled by the system: you must take control of the steering.

! You should always check the surroundings of your vehicle before starting a manoeuvre.

i The park sensors function is not available during parking space measurement. It intervenes later when manoeuvring to warn you that your vehicle is approaching an obstacle: the audible signal becomes continuous when the obstacle is less than thirty centimetres away. If you have deactivated the parking sensors, they are automatically reactivated during assisted parking manoeuvres.

! Activation of Park Assist inhibits the blind spot monitoring function.

Operation



Assistance with parallel parking manoeuvres

☞ When you have identified a parking space.



☞ Press this control.

or



☞ Select "**Park Assist**" in the "**Driving assistance**" menu of the touch screen to activate the function.



☞ Limit the speed of the vehicle to a maximum of 12 mph (20 km/h) and select "**Enter parking slot**" in the touch screen.

i To enter a parking space, the system does not identify spaces that are clearly smaller or larger than the vehicle.

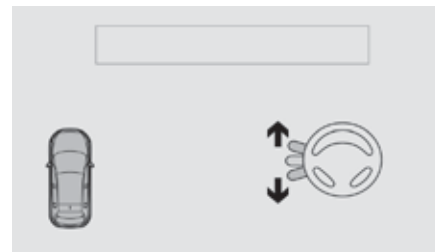

☞ Operate the direction indicator on the parking side chosen to activate the measurement function. You should drive at a distance of between 0.5 m and 1.5 m from the row of parked vehicles.

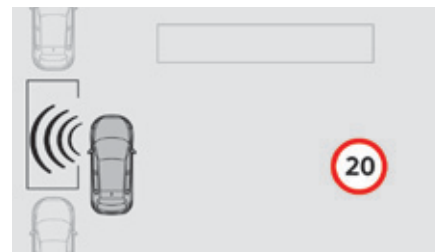

☞ Drive slowly following the instructions until the system finds a free space.

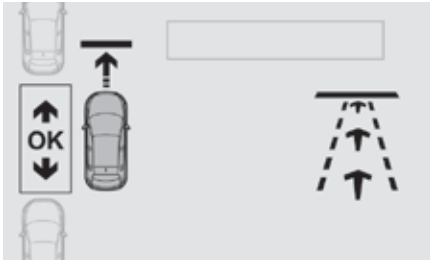

- ☞ Move forwards slowly until a message is displayed, accompanied by an audible signal, asking you to engage reverse gear.



- ☞ Select reverse, release the steering wheel and start moving without exceeding 5 mph (8 km/h).



- ☞ The assisted parking manoeuvre is in progress. Without exceeding 5 mph (8 km/h), move forwards and backwards, aided by the warnings from the "Parking sensors" system, until the indication of the end of the manoeuvre.



- ☞ At the end of the manoeuvre, the operating indicator lamp goes out in the instrument panel, accompanied by a message and an audible signal. The assistance is deactivated: you can take over control.

4



Assistance in exiting from a parallel parking space

- When you want to leave a parallel parking space, start the engine.



- With the vehicle stationary, press this control.

or



- Select "**Park Assist**" in the "**Driving assistance**" menu of the touch screen to activate the function.



- Press on "**Exit parking slot**" in the touch screen.



- Operate the direction indicator for the exit side chosen.
- Engage reverse or forward gear and release the steering wheel.



- The assisted parking manoeuvre is in progress. Without exceeding 3 mph (5 km/h), move forwards and backwards, aided by the warnings from the "Parking sensors" system, until the indication of the end of the manoeuvre.

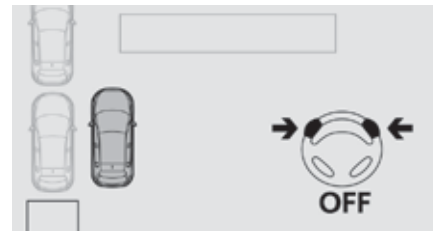

The manoeuvre is complete when the vehicle's front wheels are clear of the parking space. At the end of the manoeuvre, the indicator lamp in the instrument panel goes off, accompanied by a message and an audible signal. The assistance is deactivated: you can take over control.



Assistance with bay parking manoeuvres



- Once you have identified a parking zone, press this control at the steering wheel,

or



- Select **"Park Assist"** in the **"Driving assistance"** menu of the touch screen to activate the function.



This indicator lamp comes on in the instrument panel to confirm the activation of the function.



- Limit the speed of the vehicle to a maximum of 12 mph (20 km/h) and select **"Start parking in a bay"** on the touch screen.



- Operate the direction indicator on the parking side chosen to activate the measurement function. You should drive at a distance of between 0.5 m and 1.5 m from the row of parked vehicles.



- Drive slowly following the instructions until the system finds a free space.

- When several successive bays are found, the vehicle will be directed towards the last one.



- Move forwards slowly until a message is displayed, accompanied by an audible signal, asking you to engage reverse gear.

4



☞ Select reverse, release the steering wheel and start moving without exceeding 5 mph (8 km/h).



☞ The assisted parking manoeuvre is in progress.
Without exceeding 5 mph (8 km/h), follow the instructions displayed in the instrument panel, aided by the warnings from the "Parking sensors" system, until the indication of the end of the manoeuvre.

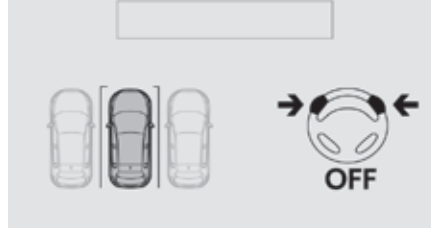

At the end of the manoeuvre, the operating indicator lamp goes out in the instrument panel, accompanied by a message and an audible signal.
The assistance is deactivated: you can take over control.

i During a bay parking manoeuvre, the Park Assist system is automatically deactivated once the rear of the vehicle is within 50 cm of an obstacle.

i During parking and exit from parking manoeuvres, the reversing camera function may come into operation. It facilitates monitoring of the surroundings of the vehicle, by displaying additional information in the instrument panel (see the corresponding section).

Deactivation

The system is deactivated automatically:

- on switching off the ignition,
- if the engine stalls,
- if no manoeuvre is started within 5 minutes of selection of the type of manoeuvre,
- after a prolonged stop of the vehicle during a manoeuvre,
- if the road wheel anti-slip regulation (ASR) is triggered,
- if the speed of the vehicle exceeds the stated limit,
- when the driver interrupts movement of the steering wheel,
- if the driver presses the Park Assist control,
- after 4 manoeuvre cycles,
- on opening the driver's door,
- if one of the front wheels encounters an obstacle.

The operation indicator lamp goes off in the instrument panel and a message is displayed accompanied by an audible signal.

The driver should then take back control of the vehicle's steering.

If the system is deactivated during a manoeuvre, the driver should reactivate it manually to repeat the measurement.

Switching off

The system is switched off automatically:

- when towing a trailer,
- if the driver's door is opened,
- if the speed of the vehicle is above 42 mph (70 km/h).

To switch the system off for a prolonged period, contact a PEUGEOT dealer or a qualified workshop.

Operating faults

SERVICE

In the event of a fault with the system, this warning lamp is displayed in the instrument panel and a message appears, accompanied by an audible signal.



The indicator lamp for the function flashes for a few seconds.

If the fault occurs during the use of the system, the indicator lamp goes off.

STOP

In the event of a fault with the power steering, this warning lamp comes on in the instrument panel accompanied by an alert message.

Contact a PEUGEOT dealer or a qualified workshop.

4

i If the lateral distance between your vehicle and the space is too great, the system may not be able to measure the space. Anything projecting beyond the envelope of the vehicle (long or wide load) is not taken into account by the Park Assist system during a manoeuvre.

! In bad weather or in winter, ensure that the sensors are not covered by road dirt, ice or snow. In the event of a fault, have the system checked by a PEUGEOT dealer or a qualified workshop.

Mirrors

Door mirrors



Each fitted with an adjustable mirror glass providing the lateral rearward vision necessary for overtaking or parking. They can also be folded for parking in confined spaces.

Demisting - Defrosting



Demisting-defrosting of the door mirrors operates with the engine running, by switching on the heated rear screen (refer to the "Rear screen demist-defrost" section).



Adjustment

- ☞ Move control **A** to the right or to the left to select the corresponding mirror.
- ☞ Move control **B** in all four directions to adjust.
- ☞ Return control **A** to the central position.

! The objects observed are, in reality, closer than they appear. Take this into account in order to correctly judge the distance of vehicles approaching from behind.



Folding

- ☞ From outside: lock the vehicle using the electronic key or the Keyless Entry and Starting system.
- ☞ From inside: with the ignition on, pull the control **A** in the central position rearwards.

i If the mirrors are folded using control **A**, they will not unfold when the vehicle is unlocked. Pull again on control **A**.

Unfolding

- ☞ From outside: unlock the vehicle using the electronic key or the Keyless Entry and Starting system.
- ☞ From inside: with the ignition on, pull the control **A** in the central position rearwards.

i The folding and unfolding of the door mirrors using the remote control can be deactivated by a PEUGEOT dealer or a qualified workshop.

If necessary, it is possible to fold the mirrors manually.

Rear view mirror

Adjustable mirror providing a central rearward view.

Equipped with an anti-dazzle system, which darkens the mirror glass and reduces the nuisance to the driver caused by the sun, headlamps from other vehicles...

! As a safety measure, the mirrors should be adjusted to reduce the "blind spot".

Manual day/night model

Adjustment

- ☞ Adjust the mirror so that the glass is directed correctly in the "day" position.

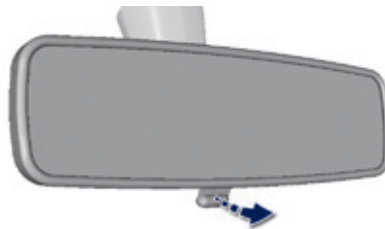

Day / night position

- ☞ Pull the lever to change to the "night" anti-dazzle position.
- ☞ Push the lever to change to the normal "day" position.

Automatic day/night model



By means of a sensor, which measures the light from the rear of the vehicle, this system automatically and progressively changes between the day and night uses.

i In order to ensure optimum visibility during your manoeuvres, the mirror lightens automatically when reverse gear is engaged.

Lighting

System for selection and control of the various front and rear lamps providing the vehicle's lighting and signalling.

Main lighting

There are various lamps on the vehicle:

- sidelamps, to be seen,
- dipped beam headlamps to see without dazzling other drivers,
- main beam headlamps to see clearly when the road is clear.

Additional lighting

Other lamps are installed to fulfil the requirements of particular driving conditions:

- rear foglamps, to better signal the presence of the vehicle in foggy conditions,
- front foglamps, for better visibility in foggy conditions and to improve lighting at intersections and when parking,
- daytime running lamps, to be seen during the day.

Automatic lighting functions

Various automatic lighting functions are also available depending on options:

- guide-me-home lighting (from a distance),
- welcome lighting,
- daytime running lamps,
- automatic illumination of headlamps.

Selection ring for main lighting mode





Turn the ring to position the symbol required facing the mark.



Model without AUTO lighting



Model with AUTO lighting

-  Lighting off.
-  Automatic illumination of headlamps.
-  Sidelamps only.
-  Dipped or main beam headlamps.

Dipping the headlamps



Pull the stalk to switch the lighting between dipped / main beam headlamps.

In the lighting off and sidelamps modes, the driver can switch on the main beam headlamps temporarily ("headlamp flash") by maintaining a pull on the stalk.

Displays

Illumination of the corresponding indicator lamp in the instrument panel confirms the lighting switched on.

Foglamp selection ring

The rear foglamps operate with the sidelamps.

The front foglamps operate with dipped beam (in manual or auto mode).



5



Rear foglamp only

- ☞ To switch it on, turn the ring forwards.
- When the lighting is switched off automatically (with AUTO model), the foglamp and the dipped beam headlamps will remain on.
- ☞ To switch it off, turn the ring rearwards.



Front and rear foglamps

- Rotate and release the ring:
- ☞ forwards a first time to switch on the front foglamps,
 - ☞ forwards a second time to switch on the rear foglamps,
 - ☞ rearwards a first time to switch off the rear foglamps,
 - ☞ rearwards a second time to switch of the front fog lamps.

- When the headlamps switch off with automatic illumination of headlamps (AUTO model) or when the dipped beam headlamps are switched off manually, the foglamps and sidelamps remain on.
- ☞ Turn the ring rearwards to switch off the foglamps, the sidelamps will then switch off.

! In good or rainy weather, both day and night, the front foglamps and the rear foglamps are prohibited. In these situations, the power of their beams may dazzle other drivers. They should only be used in fog or snow. In these weather conditions, it is your responsibility to switch on the foglamps and dipped headlamps manually as the sunshine sensor may detect sufficient light. Do not forget to switch off the front foglamps and the rear foglamps when they are no longer needed.

i **Lighting left on audible signal**

An audible signal when a front door is opened warns the driver that the vehicle's exterior lighting is on, with the ignition off and in manual lighting mode. In this case, switching off the lighting stops the audible signal. With the ignition off, if the dipped headlamps remain on, the vehicle goes into "ECO" mode to avoid discharging the battery.

The lighting goes off when you switch off the ignition, but you can always switch it on again using the lighting control stalk.

i In some weather conditions (e.g. low temperature or humidity), the presence of misting on the internal surface of the glass of the headlamps and rear lamps is normal; it disappears after the lamps have been on for a few minutes.

Daytime running lamps (LEDs)



They come on automatically when the engine is started, when the lighting control stalk is in position "0" or "AUTO".

Manual guide-me-home lighting

Temporarily keeping the dipped beam headlamps on after the vehicle's ignition has been switched off makes the driver's exit easier when the light is poor.



Switching on

- ☞ With the ignition off, "flash" the headlamps using the lighting stalk.
- ☞ A further "headlamp flash" switches the function off.

Switching off

The manual guide-me-home lighting switches off automatically after a set time.

Automatic illumination of headlamps



When a low level of ambient light is detected by a sunshine sensor, the number plate lamps, sidelamps and dipped beam headlamps are switched on automatically, without any action on the part of the driver. They can also come on if rain is detected, at the same time as automatic operation of the windscreen wipers. As soon as the brightness returns to a sufficient level or after the windscreen wipers are switched off, the lamps are switched off automatically.

Activation

- ☞ Turn the ring to the **"AUTO"** position. The activation of the function is accompanied by the display of a message.

Deactivation

- ☞ Turn the ring to another position. Deactivation of the function is accompanied by the display of a message.

Operating fault

SERVICE In the event of a malfunction of the sunshine sensor, the lighting comes on, this warning lamp is displayed

in the instrument panel accompanied by an audible signal and/or a message.

Contact a PEUGEOT dealer or a qualified workshop.

! In fog or snow, the sunshine sensor may detect sufficient light. In this case, the lighting will not come on automatically. Do not cover the sunshine sensor, coupled with the rain sensor and located in the centre of the windscreen behind the rear view mirror; the associated functions would no longer be controlled.

Automatic "guide-me-home" lighting

When the automatic illumination of headlamps function is activated, under low ambient light the dipped beams headlamps come on automatically when the ignition is switched off.

Activation or deactivation, as well as the duration of the guide-me-home lighting, is set in the **"Driving assistance"** menu, then **"Vehicle settings"** in the secondary page.

Exterior welcome lighting

The remote switching on of the lighting makes your approach to the vehicle easier in poor light. It is activated when the lighting control is in the **"AUTO"** position and the level of light detected by the sunshine sensor is low.

Switching on



Press the open padlock on the remote control or one of the front door handles with Keyless Entry and Starting.

The dipped beam headlamps and the sidelamps come on; your vehicle is also unlocked.

Switching off

The exterior welcome lighting switches off automatically after a set time, when the ignition is switched on or on locking the vehicle.

Programming

The activation, deactivation and choice of welcome lighting duration are done in the **"Driving assistance"** menu then **"Vehicle settings"**.

Mirror spotlamps



5

To make your approach to the vehicle easier, these illuminate:

- the zones facing the driver's and passenger's doors,
- the zones forward of the door mirrors and rearward of the front doors.

Switching on

The spotlamps come on:

- when you unlock the vehicle,
- when you switch off the ignition,
- when you open a door,
- when you use the remote control to locate the vehicle.

Switching off

They are timed to go off automatically.

Halogen headlamps

Manual adjustment



To avoid causing a nuisance to other road users, the beams of the halogen headlamps should be adjusted according to the load in the vehicle.

- 0** Driver or driver + front passenger.
- Driver + front passenger + rear passengers.
- 1** 5 people.
- 5 people + a load in the boot.
- 2** Driver + a load in the boot.

i The initial setting is position "0".

"Full LED" headlamps

Automatic adjustment

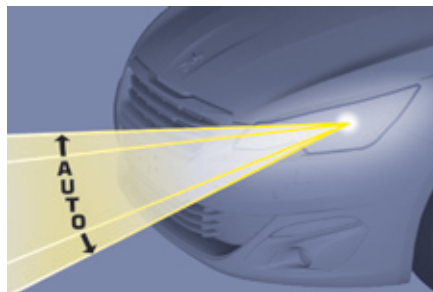

In order to avoid causing a nuisance to other road users, this system corrects the height of the "full LED" headlamps beam automatically, in relation to the load in the vehicle.

SERVICE If a fault occurs, this warning lamp is displayed in the instrument panel, accompanied by an audible signal and a message in the instrument panel screen.

The system then places your headlamps in the lowest position.

! If a fault occurs, do not touch the "full LED" bulbs. Contact a PEUGEOT dealer or a qualified workshop.

i Travelling abroad

If using your vehicle in a country that drives on the other side of the road, the headlamps must be adjusted to avoid dazzling on-coming drivers. Contact a PEUGEOT dealer or a qualified workshop.

Wipers

The vehicle's front and rear wipers are designed to improve the driver's visibility progressively according to the climatic conditions.

Programming

Various automatic wiper control modes are also available according to the following options:

- automatic rain sensitive windscreen wipers,
- rear wiping on engaging reverse gear.

Manual controls

The wipers are controlled directly by the driver.

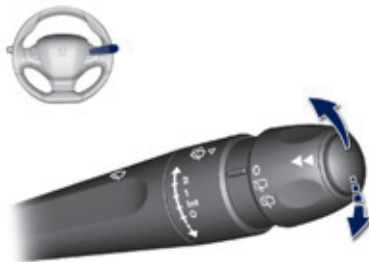

Model with manual wiping (intermittent)



Model with AUTO wiping

Windscreen wipers

Wiping speed control stalk: raise or lower the stalk to the desired position.

- 2** Fast wipe (heavy rain).
 - 1** Normal wipe (moderate rain).
 - Int** Intermittent wipe (proportional to the speed of the vehicle).
 - 0** Park.
 - ↓** Single wipe (press downwards or pull towards you, then release).
- or
- AUTO ↓** Automatic wiping (press down, then release).
 - Single wipe (pull the stalk briefly towards you).

5



Rear wiper

Rear wiper selection ring:



Park.



Intermittent wipe.



Wash-wipe (set duration).

Reverse gear

When reverse gear is engaged, the rear wiper will come into operation automatically if the windscreen wipers are operating.

i This function is activated by default. The automatic function is activated or deactivated via the "**Driving assistance**" menu.

! If a significant accumulation of snow or ice is present, or when using a bicycle carrier on the boot, deactivate the automatic rear wiper.

Windscreen and headlamp wash



☞ Pull the windscreen wiper stalk towards you. The screenwash then the wipers operate for a fixed period.

The headlamp wash is only activated **if the dipped headlamps are on**.

With daytime running lamps, to activate the headlamp wash, position the lighting stalk in the dipped beam position.

i On vehicles fitted with digital air conditioning, any action on the windscreen wash control results in temporary closing of the air intake to avoid odours inside the passenger compartment.

Screenwash/headlamp wash level low

SERVICE In the case of vehicles fitted with headlamp washers, when the fluid reservoir low level is reached this warning lamp comes on in the instrument panel, accompanied by an audible signal and a message.

The warning lamp comes on when the ignition is switched on, or every time the stalk is operated, until the reservoir is refilled. Next time you stop, refill the screenwash / headlamp wash reservoir.

Automatic rain sensitive windscreen wipers

The windscreen wipers operate automatically, without any action on the part of the driver, if rain is detected (sensor behind the rear view mirror), adapting their speed to the intensity of the rainfall.



Switching on

AUTO  Briefly push the control stalk downwards. A wiping cycle confirms that the instruction has been accepted. This warning lamp comes on in the instrument panel and a message is displayed.



Switching off

AUTO  Briefly push the control stalk downwards again, or place the control stalk in another position (Int, 1 or 2). This warning lamp goes off in the instrument panel and a message is displayed.

i The automatic rain sensitive windscreen wipers must be reactivated by pushing the control stalk downwards, if the ignition has been off for more than one minute.

Operating fault

If a fault occurs with the automatic rain sensitive wipers, the wipers will operate in intermittent mode.

Have it checked by PEUGEOT dealer or a qualified workshop.

! Do not cover the rain sensor, linked with the sunshine sensor and located in the centre of the windscreen behind the rear view mirror.

Switch off the automatic rain sensitive wipers when using an automatic car wash. In winter, it is advisable to wait until the windscreen is completely clear of ice before activating the automatic rain sensitive wipers.

Special position of the windscreen wipers



This position permits release of the windscreen wiper blades.

It is used for cleaning or replacement of the blades. It can also be useful, in winter, to detach the blades from the windscreen.

- ☞ Any action on the wiper stalk in the minute after switching off the ignition places the blades vertically on the screen.
- ☞ To park the blades again, switch on the ignition and operate the wiper stalk.

i To maintain the effectiveness of the "flat-blade" type of wiper blades, it is advisable to:

- handle them with care,
- clean them regularly using soapy water,
- avoid using them to retain cardboard on the windscreen,
- replace them at the first signs of wear.

Courtesy lamps



1. Front courtesy lamp
2. Front map reading lamps
3. Rear courtesy lamp
4. Rear map reading lamps

Front - rear courtesy lamps



In this position, the courtesy lamp comes on gradually:

- when the vehicle is unlocked,
- when the electronic key is removed from the reader,
- when opening a door,
- when the remote control locking button is activated, in order to locate your vehicle.

It switches off gradually:

- when the vehicle is locked,
- when the ignition is switched on,
- 30 seconds after the last door is closed.



Permanently off.



Permanent lighting.



Depending on version, you can also switch the courtesy lamp on or off by pressing this button.

Front - rear map reading lamps

- ☞ With the ignition on, press the corresponding switch.



Take care to avoid leaving anything in contact with the courtesy lamps.

5



With the "permanent lighting" mode, the lighting time varies according to the circumstances:

- with the ignition off, approximately ten minutes,
- in energy economy mode, approximately thirty seconds,
- with the engine running, unlimited.

Footwell lighting

Switching on



Its operation is identical to that of the courtesy lamps. The lamps come on when one of the doors is opened.

Interior mood lighting

The dimmed passenger compartment lighting improves visibility in the vehicle when the light is poor.

Switching on



At night, the courtesy lamps and lighting for the interior opening controls on the front doors come on automatically when the sidelamps are switched on.

The interior mood lighting switches off automatically when the sidelamps are switched off.

The brightness of the interior mood lighting can be adjusted in the "**Driving assistance**" menu.

- ☞ Select the "**Vehicle settings**" menu.
- ☞ Check the "**Mood lighting**" line.



Press on the "**magnifying glass**" to adjust the brightness.

Direction indicators



- ☞ Left: lower the lighting stalk passing the point of resistance.
- ☞ Right: raise the lighting stalk passing the point of resistance.

Three flashes of the direction indicators

- ☞ Press briefly upwards or downwards, without going beyond the point of resistance; the direction indicators will flash 3 times.

Hazard warning lamps

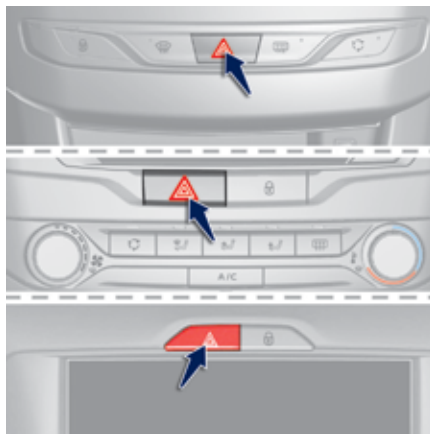

A visual warning by means of the direction indicators to alert other road users to a vehicle breakdown, towing or accident.

- ☞ Press this button, the direction indicators flash.

They can operate with the ignition off.

Automatic operation of hazard warning lamps

When braking in an emergency, depending on the rate of deceleration, as well as when the ABS regulation is invoked or in the event of an impact, the hazard warning lamps come on automatically.

They switch off automatically the first time you accelerate.

- ☞ You can also switch them off by pressing the button.

Emergency or assistance call



This system allows you to make an emergency or assistance call to the emergency services or to the dedicated PEUGEOT service.

i For more information on the use of this function, refer to the "Audio equipment and telematics" section.

Horn

Audible warning system to alert other road users to an imminent danger.

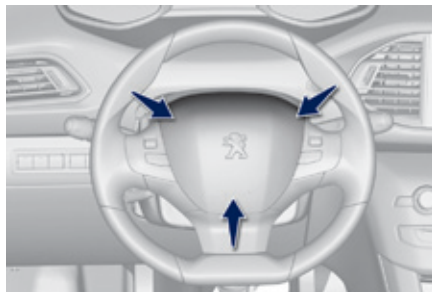

e Press the central part of the multifunction steering wheel.

i Use the horn moderately and only in the following circumstances:

- immediate danger,
- overtaking a cyclist or pedestrian,
- approaching a location lacking visibility.

Tyre under-inflation detection

System which automatically checks the pressure of the tyres while driving.

The system continuously monitors the pressures on the four tyres, once the vehicle is moving.

It compares the information given by the four wheel speed sensors with **reference values, which must be reinitialised every time the tyre pressures are adjusted or a wheel changed.**

The system triggers an alert as soon as it detects a drop in the inflation pressure of one or more tyres.



The under-inflation detection system does not replace the vigilance or the responsibility of the driver. This system does not avoid the need to check the tyre pressures (including the spare wheel) every month as well as before a long journey. Driving with under-inflated tyres impairs road holding, extends braking distances and causes premature tyre wear, particularly under arduous condition (high loading, high speed, long journey).



The inflation pressures defined for your vehicle can be found on the tyre pressure label. See the "Identification markings" section. Tyre pressures should be checked when the tyres are "cold" (vehicle stopped for 1 hour or after a journey of less than 6 miles (10 km) at moderate speeds). Otherwise, add 0.3 bar to the pressures shown on the label.



Driving with under-inflated tyres increases fuel consumption.

Under-inflation alert



This is given by fixed illumination of this warning lamp, accompanied by an audible signal and, depending on equipment, the display of a message.

- ☞ Reduce speed immediately, avoid excessive steering movements and sudden braking
- ☞ Stop the vehicle as soon as it is safe to do so.

! The loss of pressure detected does not always cause visible bulging of the tyre. Do not satisfy yourself with just a visual check.

- ☞ In the event of a puncture, use the temporary puncture repair kit or the spare wheel (depending on equipment),
- or
- ☞ if you have a compressor, such as the one in the temporary puncture repair kit, check the pressures of the four tyres when cold,
- or
- ☞ if it is not possible to make this check immediately, drive carefully at reduced speed.

i The alert is maintained until the system is reinitialised.

Reinitialisation

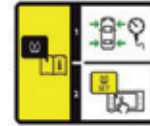

It is necessary to reinitialise the system every time one or more tyre pressure is adjusted, and after changing one or more wheels. A label attached to the middle pillar, driver's side, gives a reminder of this.

! Before reinitialising the system, ensure that the pressures of the four tyres are correct for the use of the vehicle and in line with the recommendations on the tyre pressure label. The under-inflation detection system does not give a warning if a pressure is incorrect at the time of reinitialisation.

Touch screen

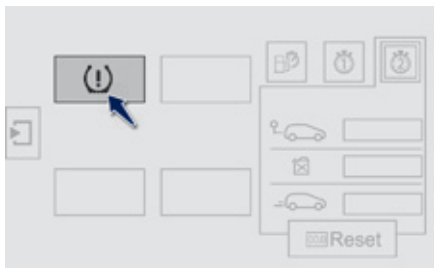

Reinitialisation of the system is done with the ignition on and the vehicle stationary.



From the "**Driving assistance**" menu of the touch screen:



☞ Press "**Under-inflation initialisation**".

☞ Confirm the instruction by pressing "**Yes**", an audible signal and a message confirm the reinitialisation.

i The new pressure settings registered are considered to be reference values by the system.

i Snow chains

The system does not have to be reinitialised after fitting or removing snow chains.

! The under-inflation alert can only be considered reliable if reinitialisation of the system is done with the the four tyre pressures correctly set.

Screen C

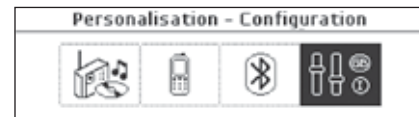

☞ Press the **MENU** button for access to the main menu.

☞ Press the "◀" or "▶" buttons to select the **Personalisation-configuration** menu, then confirm by pressing the **OK** button.



- ☞ Press the "▲" or "▼" button to select the **Define the vehicle parameters** menu, then confirm by pressing the **OK** button.

- ☞ Press the "▲" or "▼" button to select the **Driving assistance** menu, then the **Tyre pressures** menu, then the **Reinitialisation** menu, then confirming by pressing the **OK** button.
An audible signal confirms the reinitialisation.

Screen A Screen A (without audio system)



- ☞ With the ignition on and the vehicle stationary, press this button for about 3 seconds then release it, an audible signal confirms the reinitialisation.

Operating fault



The flashing and then fixed illumination of the under-inflation warning lamp accompanied by illumination of the "service" warning lamp indicates a fault with the system.

In this case, under-inflation monitoring of the tyres is no longer assured. Have the system checked by a PEUGEOT dealer or a qualified workshop.

i Before doing anything to the system, the pressures of the four tyres must be checked and the system reinitialised.

Electronic stability control (ESC)

Electronic Stability Control (ESC) incorporating the following systems:

- the anti-lock braking system (ABS) and the electronic brake force distribution (EBFD),
- the emergency braking assistance,
- the anti-slip regulation (ASR) or traction control,
- the dynamic stability control (DSC).

Definitions

Anti-lock braking system (ABS) and electronic brake force distribution (EBFD)

This system improves the stability and manoeuvrability of your vehicle when braking and provides improved control in corners, in particular on poor or slippery road surfaces.

The ABS prevents wheel lock in the event of emergency braking.

The electronic brake force distribution system manages the braking pressure wheel by wheel.

Emergency braking assistance

In an emergency, this system enables you to reach the optimum braking pressure more quickly and therefore reduce the stopping distance.

It is triggered according to the speed at which the brake pedal is pressed. This is felt by a reduction in the resistance of the pedal and an increase in the effectiveness of the braking.

Anti-slip regulation (ASR)

The ASR system (also known as Traction Control) optimises traction in order to limit wheel slip by acting on the brakes of the driving wheels and on the engine. It also improves the directional stability of the vehicle on acceleration.

Dynamic stability control (DSC)

If there is a difference between the path followed by the vehicle and that required by the driver, the DSC monitors each wheel and automatically acts on the brake of one or more wheels and on the engine to return the vehicle to the required path, within the limits of the laws of physics.

Intelligent traction control system

Depending on version, your vehicle has a system to help driving on snow: **intelligent traction control**.

This system detects situations of difficult surface adhesion that could make it difficult to move off or make progress on deep fresh snow or compacted snow.

In these situations, the **intelligent traction control** limits the amount of wheel slip to provide the best traction and trajectory control for your vehicle.

In extremely severe conditions (deep snow, mud, ...), when it proves impossible to move off, it may be useful to temporarily deactivate the ESP/ASR systems to allow the wheels to spin freely and so allow movement of the vehicle.

The use of snow tyres is strongly recommended on surfaces offering low levels of adhesion.

Operation

Anti-lock braking system (ABS) and electronic brake force distribution (EBFD)



When this warning lamp comes on, accompanied by an audible signal and a message, it indicates that there is a fault with the ABS, which could cause loss of control of the vehicle when braking.



When this warning lamp comes on, coupled with the **STOP** warning lamp, accompanied by an audible signal and a message, it indicates that there is a fault with the electronic brake force distribution (EBFD), which could cause loss of control of the vehicle when braking.
You must stop as soon as it is safe to do so.
In both cases, contact a PEUGEOT dealer or a qualified workshop.



When changing wheels (tyres and rims), make sure that these are approved for your vehicle.
Normal operation of the ABS may make itself felt by slight vibrations of the brake pedal.



In emergency braking, press very firmly without releasing the pressure.



Dynamic stability control (DSC) and anti-slip regulation (ASR)

Activation

These systems are activated automatically each time the vehicle is started.

As soon as they detect a problem of grip or trajectory, these systems act on the operation of the engine and brakes.



This is indicated by flashing of this warning lamp in the instrument panel.

Deactivation

In exceptional conditions (starting a vehicle which is bogged down, stuck in snow, on soft ground...), it may be advisable to deactivate the DSC system, so that the wheels can move freely and regain grip.

But it is recommended that the system be reactivated as soon as possible.



☞ Press the button.



This warning lamp and the indicator lamp in the button come on: the DSC system no longer acts on the operation of the engine.

Reactivation

The system is reactivated automatically each time the ignition is switched back on or from 30 mph (50 km/h).



☞ Press the button again to reactivate it manually.

Operating fault



If this warning lamp comes on, accompanied by an audible signal and a message, this indicates a fault with the system.

Contact a PEUGEOT dealer or a qualified workshop to have the system checked.

! The DSC system offers exceptional safety in normal driving, but this should not encourage the driver to take extra risks or drive at high speed. The correct operation of the system depends on observation of the manufacturer's recommendations regarding the wheels (tyres and rims), the braking components, the electronic components and the assembly and repair procedures used by PEUGEOT dealers. After an impact, have the system checked by a PEUGEOT dealer or a qualified workshop.

Seat belts

Front seat belts



The front seat belts are fitted with a pretensioning and force limiting system. This system improves safety in the front seats in the event of a front or side impact. Depending on the severity of the impact, the pretensioning system instantly tightens the seat belts against the body of the occupants. The pretensioning seat belts are active when the ignition is on. The force limiter reduces the pressure of the seat belt on the chest of the occupant, so improving their protection.

Rear seat belts



The rear seats are each fitted with a seat belt, three-point anchorages with inertia reel and force limiter (except for the centre rear seat).



Fastening

- ☞ Pull the strap, then insert the tongue in the buckle.
- ☞ Check that the seat belt is fastened correctly by pulling the strap.

Unfastening

- ☞ Press the red button on the buckle.
- ☞ Guide the seat belt as it reels in.



Seat belt not fastened / unfastened warning lamps

1. Front and/or rear seat belts not fastened / unfastened warning lamp in the instrument panel.
2. Front left seat belt warning lamp.
3. Front right seat belt warning lamp.
4. Rear right seat belt warning lamp.
5. Rear centre seat belt warning lamp.
6. Rear left seat belt warning lamp.



From approximately 12 mph (20 km/h), the warning lamp(s) flash for two minutes accompanied by an audible signal. Once these two minutes have elapsed, the warning lamp(s) remain on until the driver or one or more passengers fasten their seat belt.

Front and rear seat belt warning lamps



On switching on the ignition, warning lamp 1 comes on in the instrument panel and the corresponding warning lamp (2 to 6) comes on in red in the passenger's seat belt and front airbag warning lamp display if the corresponding seat belt is not fastened or is unfastened.

i If a rear seatbelt is not fastened, the corresponding warning lamp (4 to 6) comes on for about 30 seconds.

i The driver must ensure that passengers use the seat belts correctly and that they are all restrained securely before setting off. Wherever you are seated in the vehicle, always fasten your seat belt, even for short journeys. Do not interchange the seat belt buckles as they will not fulfil their role fully. The seat belts are fitted with an inertia reel permitting automatic adjustment of the length of the strap to your size. The seat belt is stowed automatically when not in use. Before and after use, ensure that the seat belt is reeled in correctly. The lower part of the strap must be positioned as low as possible on the pelvis. The upper part must be positioned in the hollow of the shoulder. The inertia reels are fitted with an automatic locking device which comes into operation in the event of a collision, emergency braking or if the vehicle rolls over. You can release the device by pulling firmly on the strap and releasing it so that it reels in slightly.

In order to be effective, a seat belt must:

- be tightened as close to the body as possible,
- be pulled in front of you with a smooth movement, checking that it does not twist,
- be used to restrain only one person,
- not bear any trace of cuts or fraying,
- not be converted or modified to avoid affecting its performance.

In accordance with current safety regulations, for all repairs on your vehicle, go to a qualified workshop with the skills and equipment needed, which a PEUGEOT dealer is able to provide.

Have your seat belts checked regularly by a PEUGEOT dealer or a qualified workshop, particularly if the straps show signs of damage.

Clean the seat belt straps with soapy water or a textile cleaning product, sold by PEUGEOT dealers.

After folding or moving a seat or rear bench seat, ensure that the seat belt is positioned and reeled in correctly.

Recommendations for children

Use a suitable child seat if the passenger is less than 12 years old or shorter than one and a half metres. Never use the same seat belt to secure more than one person. Never allow a child to travel on your lap.

In the event of an impact

Depending on the nature and seriousness of the impact, the pretensioning device may be deployed before and independently of the airbags. Deployment of the pretensioners is accompanied by a slight discharge of harmless smoke and a noise, due to the activation of the pyrotechnic cartridge incorporated in the system.

In all cases, the airbag warning lamp comes on.

Following an impact, have the seat belts system checked, and if necessary replaced, by a PEUGEOT dealer or a qualified workshop.

Airbags

System designed to maximise the safety of the occupants (with the exception of the rear centre passenger) in the event of violent collisions.

The airbags supplement the action of the force-limiting seat belts (with the exception of the centre rear passenger).

If a collision occurs, the electronic detectors record and analyse the front and side impacts sustained in the impact detection zones:

- in the case of a serious impact, the airbags are deployed instantly and contribute towards better protection of the occupants of the vehicle (with the exception of the rear centre passenger); immediately after the impact, the airbags deflate rapidly so that they do not hinder visibility or the exit of the occupants,
- in the case of a minor or rear impact or in certain roll-over conditions, the airbags will not be deployed; the seat belt alone contributes towards ensuring your protection in these situations.

! **The airbags do not operate when the ignition is switched off.**

This equipment will only deploy once. If a second impact occurs (during the same or a subsequent accident), the airbag will not be deployed again.

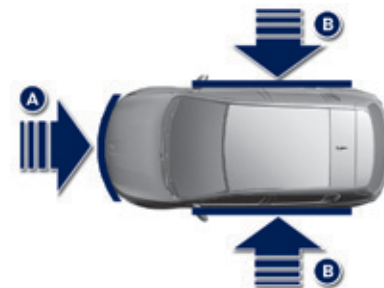

Impact detection zones

- A. Front impact zone.
- B. Side impact zone.

i Deployment of the airbag(s) is accompanied by a slight emission of smoke and a noise, due to the activation of the pyrotechnic cartridge incorporated in the system. This smoke is not harmful, but sensitive individuals may experience slight irritation. The noise of the detonation may result in a slight loss of hearing for a short time.

Front airbags

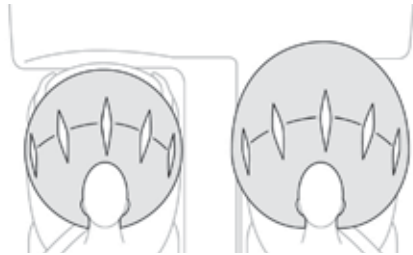

System which protects the driver and front passenger in the event of a serious front impact in order to limit the risk of injury to the head and thorax.

The driver's airbag is fitted in the centre of the steering wheel; the front passenger's airbag is fitted in the dashboard above the glove box.

Deployment

The airbags are deployed, except the passenger's front airbag if it is deactivated, in the event of a serious front impact to all or part of the front impact zone **A**, in the longitudinal centreline of the vehicle on a horizontal plane and directed from the front to the rear of the vehicle.

The front airbag inflates between the thorax and head of the front occupant of the vehicle and the steering wheel, driver's side, and the dashboard, passenger's side to cushion their forward movement.



Deactivating the passenger's front airbag

Only the passenger's front airbag can be deactivated.

- ☞ **With the ignition off**, insert the key in the passenger airbag deactivation switch.
- ☞ Turn it to the **"OFF"** position.
- ☞ Remove the key keeping the switch in the new position.



When the ignition is on, this warning lamp comes in the seat belt display screen. It stays on while the airbag is deactivated.

! To assure the safety of your child, the passenger's front airbag must be deactivated when you install a "rear facing" child seat on the front passenger seat. Otherwise, the child would risk being seriously injured or killed if the airbag were deployed.

Reactivating the passenger's front airbag

When you remove the child seat, **with the ignition off**, turn the switch to the **"ON"** position to reactivate the airbag and so assure the safety of your front passenger in the event of an impact.



When the ignition is switched on, this warning lamp comes on in the seat belt display screen for approximately one minute to signal that the front airbag is activated.

Operating fault



If this warning lamp comes on in the instrument panel, accompanied by an audible warning and a message, contact a PEUGEOT dealer or a qualified workshop to have the system checked. The airbags may no longer be deployed in the event of a serious impact.



If this warning lamp flashes, contact a PEUGEOT dealer or a qualified workshop. The passenger's front airbag may no longer be deployed in the event of a serious impact.



In the event of a fault, identified by at least one of the two airbag warning lamps, do not install a child seat or seat an adult on the front passenger seat. Have it checked by a PEUGEOT dealer or qualified workshop.

Lateral airbags



System which protects the driver and front passenger in the event of a serious side impact in order to limit the risk of injury to the chest, between the hip and the shoulder. Each lateral airbag is fitted in the seat backrest frame, door side.

Deployment

The lateral airbags are deployed unilaterally in the event of a serious side impact applied to all or part of the side impact zone, perpendicular to the longitudinal centreline of the vehicle on a horizontal plane and directed from the outside towards the inside of the vehicle.

The lateral airbag inflates between the hip and shoulder of the front occupant of the vehicle and the corresponding door trim panel.

Curtain airbags

System which protects the driver and passengers (with the exception of the rear centre passenger) in the event of a serious side impact in order to limit the risk of injury to the side of the head.

Each curtain airbag is built into the pillars and the upper passenger compartment area.

Deployment

The curtain airbag is deployed at the same time as the corresponding lateral airbag in the event of a serious side impact applied to all or part of the side impact zone **B**, perpendicular to the longitudinal centreline of the vehicle on a horizontal plane and directed from the outside towards the inside of the vehicle.

The curtain airbag inflates between the front or rear occupant of the vehicle and the windows.

Operating fault



If this warning lamp comes on in the instrument panel, accompanied by an audible signal and a message, contact a PEUGEOT dealer or a qualified workshop to have the system checked. The airbags may no longer be deployed in the event of a serious impact.

! In the event of a minor impact or bump on the side of the vehicle or if the vehicle rolls over, the airbags may not be deployed. In the event of a rear or front collision, none of the lateral airbags is deployed.

! For the airbags to be fully effective, observe the following safety rules:

Sit in a normal upright position.

Wear a correctly adjusted seat belt.

Do not leave anything between the occupants and the airbags (a child, pet, object...). This could hamper the operation of the airbags or injure the occupants.

After an accident or if the vehicle has been stolen or broken into, have the airbag systems checked.

All work on the airbag system must be carried out by a PEUGEOT dealer or a qualified workshop.

Even if all of the precautions mentioned are observed, a risk of injury or of minor burns to the head, chest or arms when an airbag is deployed cannot be ruled out. The bag inflates almost instantly (within a few milliseconds) then deflates within the same time discharging the hot gas via openings provided for this purpose.

Front airbags

Do not drive holding the steering wheel by its spokes or resting your hands on the centre part of the wheel.

Passengers must not place their feet on the dashboard.

If possible, do not smoke as deployment of the airbags can cause burns or the risk of injury from a cigarette or pipe.

Never remove or pierce the steering wheel or hit it violently.

Lateral airbags

Use only approved covers on the seats, compatible with the deployment the lateral airbags. For information on the range of seat covers suitable for your vehicle, you can contact a PEUGEOT dealer.

Refer to the "Accessories" section.

Do not fix or attach anything to the seat backs (clothing...). This could cause injury to the chest or arms if the lateral airbag is deployed.

Do not sit with the upper part of the body any nearer to the door than necessary.

Curtain airbags

Do not fix or attach anything to the roof. This could cause injury to the head if the curtain airbag is deployed.

If fitted on your vehicle, do not remove the grab handles installed on the roof, they play a part in securing the curtain airbags.

General points relating to child seats

Although one of PEUGEOT main criteria when designing your vehicle, the safety of your children also depends on you.

For maximum safety, please observe the following recommendations:

- in accordance with European regulations, **all children under the age of 12 or less than one and a half metres tall must travel in approved child seats suited to their weight**, on seats fitted with a seat belt or ISOFIX mountings*,
- **statistically, the safest seats in your vehicle for carrying children are the rear seats**,
- **a child weighing less than 9 kg must travel in the "rearward facing" position both in the front and in the rear.**

- i** **PEUGEOT recommends** that children should travel on the **rear seats** of your vehicle:
- **"rearward-facing"** up to the age of 3,
 - **"forward-facing"** over the age of 3.

* The rules for carrying children are specific to each country. Refer to the legislation in force in your country.

Child seat at the rear

"Rearward facing"

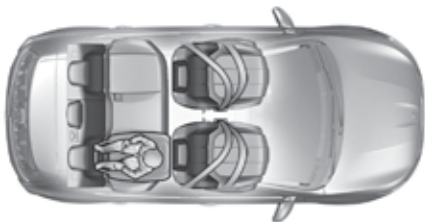

When a "rearward facing" child seat is installed **on a rear passenger seat**, move the vehicle's front seat forwards and straighten the backrest so that the "rearward facing" child seat does not touch the vehicle's front seat.

"Forward facing"

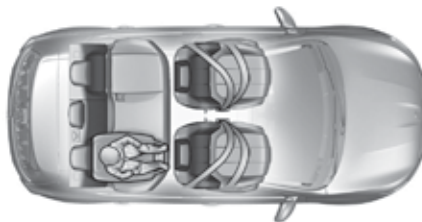

When a "forward facing" child seat is installed **on a rear passenger seat**, move the vehicle's front seat forwards and straighten the backrest so that the legs of the child in the "forward facing" child seat do not touch the vehicle's front seat.

- i** Ensure that the seat belt is correctly tensioned.
For child seats with a support leg, ensure that this is in firm contact with the floor. If necessary, adjust the front seat of the vehicle.

Centre rear seat

A child seat with a support leg must never be installed on the **centre rear passenger seat**.

Child seat in the front*

"Rearward facing"



When a "rearward facing" child seat is installed on the **front passenger seat**, adjust the seat to the fully back and highest position, with the backrest straightened.

The passenger airbag must be deactivated.

Otherwise, **the child would risk being seriously injured or killed if the airbag were to inflate.**

"Forward facing"



When a "forward facing" child seat is installed on the **front passenger seat**, adjust the vehicle's seat to the fully back and highest position with seat backrest straightened and leave the passenger's airbag activated.



Passenger seat in the fully back and highest position.

- i** Ensure that the seat belt is correctly tensioned.
For child seats with a support leg, ensure that the support leg is in firm and stable contact with the floor. If necessary, adjust the passenger seat.

* Refer to the legislation in force in your country before carrying your child in this seating position.

Deactivating the passenger's front airbag

! Never install a rearward facing child restraint system on a seat protected by an active front airbag. This could cause the death of the child or serious injury.

The warning label present on both sides of the passenger's sun visor repeats this advice. In line with current legislation, the following tables contain this warning in all of the languages required.



Passenger airbag OFF



i For information on deactivating the passenger's front airbag, refer to the "Airbags" section.

AR	لا يجب أبدا تركيب نظام لإجلال الطفل الوجه باتجاه الورا على مقعد سيارة مجهز بوسادة امان هوائية أمامية مغلقة، فقد يؤدي هذا إلى التسبب بموت الطفل أو بإصابات خطيرة لديه .
BG	НИКОГА НЕ инсталирайте детско столче на седалка с АКТИВИРАНА предна ВЪЗДУШНА ВЪЗГЛАВНИЦА. Това можеда причини СМЪРТ или СЕРИОЗНО НАРАНЯВАНЕ на детето.
CS	NIKDY neumistujte dětské zádržné zařízení orientované směrem dozadu na sedadlo chráněné AKTIVOVANÝM čelním AIRBAGEM. Hrozí nebezpečí SMRTI DÍTĚTE nebo VÁŽNĚHO ZRANĚNÍ.
DA	Brug aldrig en bagudvendt barnestol på et sæde der er beskyttet af en aktiv airbag. Død eller alvorlig skade på barnet kan forekomme.
DE	Verwenden Sie NIEMALS einen Kindersitz oder Babyschale gegen die Fahrtrichtung bei AKTIVIERTEM Airbag, TOD oder ERNSTHAFTE VERLETZUNGEN können die Folge sein.
EL	Μη χρησιμοποιείτε ΠΟΤΕ παιδικό κάθισμα με την πλάτη του προς το εμπρός μέρος του αυτοκινήτου, σε μια θέση που προστατεύεται από ΜΕΤΩΠΙΚΟ αερόσακο που είναι ΕΝΕΡΓΟΣ. Αυτό μπορεί να έχει σαν συνέπεια το ΘΑΝΑΤΟ ή το ΣΟΒΑΡΟ ΤΡΑΥΜΑΤΙΣΜΟ του ΠΑΙΔΙΟΥ
EN	NEVER use a rearward facing child restraint on a seat protected by an ACTIVE AIRBAG in front of it, DEATH or SERIOUS INJURY to the CHILD can occur
ES	NO INSTALAR NUNCA EL SISTEMA DE RETENCIÓN PARA NIÑOS DE ESPALDAS AL SENTIDO DE LA CIRCULACIÓN SOBRE UN ASIENTO PROTEGIDO CON UN COJÍN INFLABLE FRONTAL (AIRBAG) ACTIVADO. ESTO PUEDE CAUSAR LA MUERTE DEL BEBE O HERIRLO GRAVEMENTE.
ET	Ärge kasutage kunagi lapse turvatooli seljaga sõidusuunas sõiduki istmel mis on kaitstud AKTIVEERITUD TURVAPADJAGA. See võib põhjustada lapsele RASKEID VIGASTUSI või SURMA.
FI	ÄLÄ KOSKAAN aseta lapsen turvaistuinta selkä ajosuuntaan istuimelle, jonka edessä suojana on käyttöön aktivoitu TURVATYÖNY. Sen laukeaminen voi aiheuttaa LAPSEN KUOLEMAN tai VAKAVAN LOUKKAANTUMISEN.
FR	NE JAMAIS installer de système de retenue pour enfants faisant face vers l'arrière sur un siège protégé par un COUSSIN GONFLABLE frontal ACTIVE. Cela peut provoquer la MORT de l'ENFANT ou le BLESSER GRAVEMENT
HR	NIKADA ne postavljati dječju sjedalicu leđima u smjeru vožnje na sjedalo zaštićeno UKLJUČENIM prednjim ZRAČNIM JASTUKOM. To bi moglo uzrokovati SMRT ili TEŠKU OZLJEDU djeteta.
HU	SOHA ne használjon menetiránynak háttal beszerelt gyermekülést olyan ülésen, amely AKTIVÁLT ÁLLAPOTÚ (BEKAPCSOLT) FRONTLEGZSÁKKAL van védve. Ez a gyermek halálát vagy súlyos sérülését okozhatja.
IT	NON installare MAI seggiolini per bambini posizionati in senso contrario a quello di marcia su un sedile protetto da un AIRBAG frontale ATTIVATO. Ciò potrebbe provocare la MORTE o FERITE GRAVI al bambino.

LT	NIEKADA neįrenkite vaiko prilaikymo priemonės su atgal atgretžtu vaiku ant sėdynės, kuri saugoma VEIKIANČIOS priekinės ORO PAGALVĖS. Išsiskleidus oro pagalvei vaikas gali būti MIRTINAI arba SUNKIAI TRAUMUOTAS.
LV	NAV PIĒLAUJAMS uzstādīt uz aizmuguri vērstu bērnu sēdekļi priekšējā pasažiera vietā, kurā ir AKTIVIZĒTS priekšējais DROŠĪBAS GAISA SPĪLVENS. Tas var izraisīt BĒRNA NĀVI vai radīt NOPIETNUS IEVAINOJUMUS.
MT	Qatt m'ghandek thalli tifel/tifla marbut f'siggu dahru lejn l-Airbag attiva, ghalix tista' tikkawza korriment serju jew anke mewt lit-tifel/tifla
NL	Plaats NOOIT een kinderzitje met de rug in de rijrichting op een zitplaats waarvan de AIRBAG is INGESCHAKELD. Bij het afgaan van de airbag kan het KIND ERNSTIG OF DODELIJK GEWOND raken.
NO	Installer ALDRI et barnesete med ryggen mot kjøretretningen i et sete som er beskyttet med en frontal AKTIVERT KOLLISJONSPUTE, BARNET risikerer å bli DREPT eller HARDT SKADET.
PL	NIGDY nie instalować fotelika dziecięcego w pozycji "tyłem do kierunku jazdy" na siedzeniu wyposażonym w CZOŁOWĄ PODUSZKĘ POWIETRZNAJĄ w stanie AKTYWNYM. W przeciwnym razie dziecko narażone będzie na ŚMIERĆ lub BARDZO POWAŻNE OBRAŻENIA CIAŁA w momencie wyzwolenia poduszki powietrznej
PT	NUNCA instale um sistema de retenção para crianças de costas para a estrada, num banco protegido por um AIRBAG frontal ACTIVADO. Esta instalação poderá provocar FERIMENTOS GRAVES ou a MORTE da CRIANÇA.
RO	Nu instalati NICIODATA un sistem de retinere pentru copii, dispus cu spatele in directia de mers, pe un loc din vehicul protejat cu AIRBAG frontal ACTIVAT. Aceasta ar putea provoca MOARTEA COPILULUI sau RANIREA lui GRAVA.
RU	ВО ВСЕХ СЛУЧАЯХ ЗАПРЕЩАЕТСЯ использовать обращенное назад детское удерживающее устройство на сиденье, защищенном ФУНКЦИОНИРУЮЩЕЙ ПОДУШКОЙ БЕЗОПАСНОСТИ, установленной перед этим сиденьем. Это может привести к ГИБЕЛИ РЕБЕНКА или НАНЕСЕНИЮ ЕМУ СЕРЬЕЗНЫХ ТЕЛЕСНЫХ ПОВРЕЖДЕНИЙ
SK	NIKDY nepoužívajte na prednom sedadle chránenom AKTÍVNYM AIRBAGOM detské zadržívacie zariadenie umiestnené v proti smere jazdy. Môže to spôsobiť SMŤ, alebo VÁŽNE ZRANENIE DIEŤATA.
SL	NIKOLI ne nameščajte otroškega sedeža s hrbtom v smeri vožnje, če je VARNOSTNA BLAZINA pred sprednjim sopotnikovim sedežem AKTIVIRANA. Takšna namestitve lahko povzročijo SMRT OTROKA ali HUDE POŠKODBE.
SR	NIKADA ne koristite dečje sedišta koje se okreće unazad na sedištu zaštićenim AKTIVNIM VAZDUŠNIM JASTUKOM ispred njega, jer mogu nastupiti SMRT ili OZBILJNA POVREDA DETETA.
SV	Använd ALDRIG en bakåtvänd barnstol i ett säte skyddat av en AKTIV AIRBAG framför det. Det kan orsaka ALLVARLIGA eller DÖDLIGA skador på barnet.
TR	KESİNLİKLE HAVA YASTIĞI AKTİF olan ön koltuğa yüzü arkaya dönük bir çocuk koltuğu yerleştirmeyiniz. Bu ÇOCUĞUN ÖLMESİNE veya ÇOK AĞIR YARALANMASINA sebep olabilir.

Child seats recommended by PEUGEOT

PEUGEOT offers a complete range of recommended child seats which are secured using a **three point seat belt**.

Group 0+: from birth to 13 kg



L1

"RÖMER Baby-Safe Plus"

Installed in the rearward facing position.

Groups 2 and 3: from 15 to 36 kg



L4

"KLIPPAN Optima"

From 22 kg (approximately 6 years), the booster is used on its own.



L5







"RÖMER KIDFIX"

Can be fitted to the vehicle's ISOFIX mountings.

The child is restrained by the seat belt.

Locations for child seats secured with the seat belt

In accordance with the European regulation, this table indicates the options for the installation of child seats secured using the seat belt and universally approved (a) in relation to the weight of the child and the seat in the vehicle.

Weight of the child / indicative age					
Seat		Less than 13 kg (groups 0 (b) and 0+) Up to 1 year approx	From 9 to 18 kg (group 1) From 1 to 3 years approx	From 15 to 25 kg (group 2) From 3 to 6 years approx	From 22 to 36 kg (group 3) From 6 to 10 years approx
Front passenger seat (c) - with height adjustment - without height adjustment (straightening the backrest)		U (R)	U (R)	U (R)	U (R)
		U (R)	U (R)	U (R)	U (R)
Saloon					
Outer rear seats (d)		U	U	U	U
Centre rear seat (d)		U (1)	U (1)	U	U
SW					
Outer rear seats (d)		U	U	U	U
Centre rear seat (d)		X	X	X	X

U: seat suitable for the installation of a child seat secured using the seat belt and universally approved "rearward facing" and/or "forward facing".

U(R): as for **U**, the vehicle seat must be adjusted to the lowest position with 11 operations of the seat height adjuster and intermediate longitudinal position.

X: seat not suitable for the installation of a child seat of the weight group indicated.

- (a) universal child seat: child seat which can be installed in all vehicles using the seat belt.
 - (b) group 0: from birth to 10 kg. Infant car seats and "car cots" cannot be installed on the front passenger seat.
 - (c) consult the legislation in force in your country before installing your child on this seat.
 - (d) to install a child seat on a rear seat, rearward or forward facing, move the front seat forward, then straighten the backrest to allow enough room for the child seat and the child's legs.
- (1) a child seat with support leg must never be installed on the centre rear passenger seat.

i Remove and stow the head restraint before fitting a child seat with a backrest to a passenger seat. Refit the head restraint when the child seat is removed.

"ISOFIX" mountings

Your vehicle has been approved in accordance with the **latest ISOFIX regulations**.
The seats shown below are fitted with regulation ISOFIX mountings.

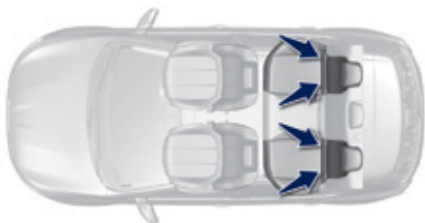

Saloon

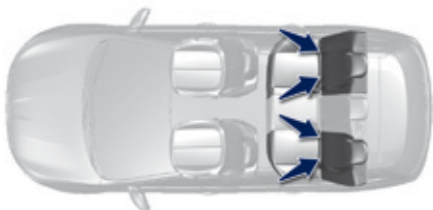

SW



There are three rings for each seat.

- Two rings **A**, located between the vehicle seat back and cushion, indicated by an ISOFIX marking.

- i** These rings are located behind covers. For access to them:
- ☞ Pull forwards to unclip the cover and pivot it upwards.

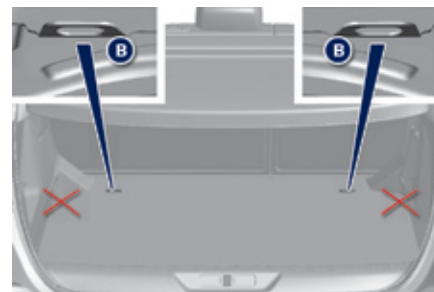

- A ring **B** located in the boot (indicated by a marking), referred to as the **TOP TETHER** for fixing the upper strap.

The TOP TETHER is used to secure the upper strap of child seats that have them. This limits the forward tipping of the child seat in the event of a frontal impact.

The TOP TETHER is located on the boot floor behind the seat backrest.

! Do not use the luggage net rings (saloon) or lashing rings (SW), located at the edges of the boot floor.

This ISOFIX mounting system provides fast, reliable and safe fitting of the child seat in your vehicle.

The **ISOFIX child seats** are fitted with two latches which are easily secured on the two rings **A**.

Some also have an **upper strap** which is attached to ring **B**.

To secure the child seat to the top tether:

- Remove and stow the head restraint before installing the child seat on the vehicle seat (refit it when the child seat is removed).
- Pass the child seat upper strap over the top of the seat backrest, centred between the holes for the head restraint rods.
- Attach the upper strap to the ring **B**.
- Tighten the upper strap.

! The incorrect installation of a child seat in a vehicle compromises the child's protection in the event of an accident.

Observe strictly the fitting instructions provided with the child seat.

For information regarding the ISOFIX child seats which can be installed in your vehicle, refer to the table showing the locations for installing ISOFIX child seats.

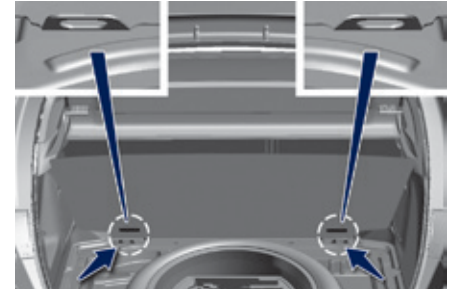

If your vehicle has a spare wheel of the same size as the four wheels, follow the procedure below:

- ☞ Pass the strap and buckle over the boot floor (in the slot).
- ☞ Raise the boot floor.
- ☞ Lift out the upper storage box, located alongside the wheel.
- ☞ Attach the buckle to the **TOP TETHER** ring.
- ☞ Refit the storage box and boot floor.

ISOFIX child seats recommended by PEUGEOT

"RÖMER Baby-Safe Plus and its Baby-Safe Plus ISOFIX base" (size category: E)

Group 0+: from birth to 13 kg



Installed "rearward facing" using an ISOFIX base which is attached to the rings **A**. The base has a support leg, adjustable for height, which sits on the vehicle's floor. This seat can be secured with a seat belt. In this case, only the shell is used and attached to the vehicle's seat by the three-point seat belt.

Baby P2C Midi and its ISOFIX base (size categories: D, C, A, B, B1)

Group 1: from 9 to 18 kg



Installed "rearward facing" using an ISOFIX base which is attached to the rings **A**. The base has a support leg, adjustable for height, which sits on the vehicle's floor. This child seat can also be used "forward facing". This seat can **not** be secured with a seat belt. We recommend that you use the seat in the "rearward facing" position up to the age of 3 years.

i Follow the instructions for fitting child seats contained in the seat manufacturer's installation guide.

RÖMER Duo Plus ISOFIX (size category **B1**)

Group 1: from 9 to 18 kg



Is installed in the forward facing position.
Is attached to the rings **A** and the upper ring **B**, referred to as the Top Tether, using an upper strap.
Three seat body angles: sitting, reclining, lying down.

i This seat can be used on seats not fitted with ISOFIX mountings.
In this case, it must be attached to the vehicle's seat using the three-point seat belt.
Adjust the front seat of the vehicle so that the child's feet do not touch the backrest.

FAIR G 0/1 S and its base **RWF B ISOFIX** (size category **C**)

Group 0+ and 1: from birth to 18 kg







Is installed "rearward facing".
Is installed using an ISOFIX base attached to the rings **A**.
6 seat body angles.
Use the **type B** ISOFIX base **rearward facing (RWF)**.
This child seat can also be used in the "forward facing" position
on seating positions not fitted with ISOFIX mountings.
In this case, the child seat body must be attached to the seat of the vehicle
by the three point seat belt.

i Follow the instructions for fitting child seats contained in the seat manufacturer's installation guide.

Locations for ISOFIX child seats

In accordance with European Regulations, this table indicates the options for installing ISOFIX child seats on seats in the vehicle fitted with ISOFIX mountings.

In the case of universal and semi-universal ISOFIX child seats, the ISOFIX size category, determined by a letter from **A** to **G**, is indicated on the child seat next to the ISOFIX logo.

	Weight of the child / indicative age									
	Less than 10 kg (group 0) Up to approx. 6 months		Less than 10 kg (group 0) Less than 13 kg (group 0+) Up to approx. 1 year			From 9 to 18 kg (group 1) From approx. 1 to 3 years				
Type of ISOFIX child seat	Infant carrier		"rearward facing"			"rearward facing"		"forward facing"		
ISOFIX size category	F	G	C	D	E	C	D	A	B	B1
Front passenger seat 	Not ISOFIX									
Saloon										
Outer rear seats 	IL-SU (1+2)	IL-SU (3)	IL-SU (1)	IL-SU (3)	IL-SU (1)	IL-SU (3)	IL-SU (1)	IUF IL-SU		
Centre rear seat 	Not ISOFIX									
SW										
Outer rear seats 	IL-SU (1+2)	IL-SU (3)	IL-SU (1)	IL-SU (3)	IL-SU (1)	IL-SU (3)	IL-SU (1)	IUF IL-SU		
Centre rear seat 	Not ISOFIX									

IUF: seat suitable for the installation of an Isofix Universal seat, "Forward facing" secured using the upper strap.

IL-SU: seat suitable for the installation of an Isofix Semi-Universal seat either:

- "rear facing" fitted with an upper strap or a support leg,
- "forward facing" fitted with a support leg,
- an infant car seat fitted with an upper strap or a support leg.

X: seat not suitable for the installation of a child seat for the weight group indicated.

- (1) move a seat without height adjustment forwards by 1 notch from the mid position forwards and backwards A seat with height adjustment must be in the highest position.
- (2) the installation of an infant carrier on one of the outer seats makes use of the other two seats impossible.
- (3) a seat with height adjustment must be placed in the highest position. Move the seat without height adjustment forward by 5 notches from the mid-position forwards and backwards.

 For advice on securing of the upper strap, refer to the "ISOFIX mountings" section.

 Remove and stow the head restraint before fitting a child seat with a backrest to a passenger seat. Refit the head restraint when the child seat is removed.

Advice

! Child seats

The incorrect installation of a child seat in a vehicle compromises the child's protection in the event of an accident.

Check that there is no seat belt or seat belt buckle under the child seat as this could destabilise it.

Remember to fasten the seat belts or the child seat harnesses **keeping the slack** in relation to the child's body **to a minimum**, even for short journeys.

For the installation of a child seat using a seat belt, ensure that this is well tensioned on the child seat and that it is holding the child seat firmly against the seat of your vehicle. If your front passenger seat is adjustable, move it forward if necessary. At the rear seats, always leave sufficient space between the front seat and:

- a rearward facing child seat,
- the feet of a child seated in a forward facing child seat.

For this, move the front seat forward and if necessary straighten its backrest.

For optimum installation of the "forward facing" child seat, ensure that the back of the child seat is as close as possible to the backrest of the vehicle's seat, or in contact if possible.

The head restraint must be removed before installing a child seat with a backrest on the passenger seat.

Ensure that the head restraint is stowed or attached securely so that it is not thrown around the vehicle in the event of sharp braking.

Refit the head restraint as soon as the child seat is removed.

Children at the front

The legislation on carrying a child on the front passenger seat is specific to each country. Refer to the legislation in force in your country.

Deactivate the passenger's airbag when a "rearward facing" child seat is installed on the front seat. Otherwise, the child would risk being seriously injured or killed if the airbag were deployed.

Installing a booster cushion

The chest part of the seat belt must be positioned on the child's shoulder without touching the neck.

Ensure that the lap part of the seat belt passes correctly over the child's thighs. PEUGEOT recommends the use of a booster seat which has a back, fitted with a seat belt guide at shoulder level.

As a safety precaution, do not leave:

- one or more children alone and unsupervised in a vehicle,
- a child or an animal in a vehicle which is exposed to the sun, with the windows closed,
- the keys within reach of children inside the vehicle.

To prevent accidental opening of the doors, use the "Child lock".

Take care not to open the rear windows by more than one third.

To protect young children from the rays of the sun, fit side blinds on the rear windows.

Child lock

This mechanical system prevents opening of the rear door using its interior control.

The control is located on the edge of each rear door and locking is independent for each door.



Locking

- ☞ Using the integral ignition key, turn the control as far as it will go:
 - to the left on the left-hand rear door,
 - to the right on the right-hand rear door.

Unlocking

- ☞ Using the integral ignition key, turn the control as far as it will go:
 - to the right on the left-hand rear door,
 - to the left on the right-hand rear door.

Temporary puncture repair kit

Complete system consisting of a compressor and a sealant cartridge which permits **temporary repair** of a tyre so that you can drive to the nearest garage.

It is designed to repair most punctures which could affect the tyre, located on the tyre tread or shoulder.

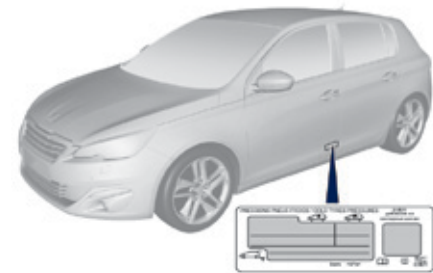
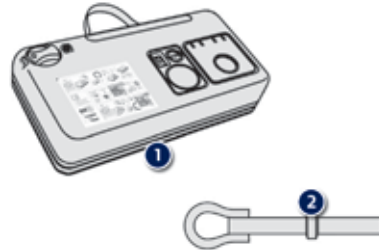

Access to the kit



This kit is installed in the storage box, under the boot floor.

List of tools

These tools are specific to your vehicle and can vary according to equipment. Do not use them for other purposes.

1. 12 V compressor.
Contains a sealant cartridge for the temporary repair of a tyre and can also be used for adjusting tyre pressures.
2. Removable towing eye.
See the "Towing the vehicle" section.

The tyre inflation pressures are given on this label.

! The vehicle's electric system allows the connection of a compressor for long enough to inflate a tyre after a puncture repair or for inflating a small inflatable accessory.

Description of the kit



- A. "Sealant" or "Air" position selector.
- B. On "I" / off "O" switch.
- C. Deflation button.
- D. Pressure gauge (in bar and p.s.i.).
- E. Compartment housing:
 - a cable with adaptor for 12 V socket,
 - various inflation adaptors for accessories, such as balls, bicycle tyres...

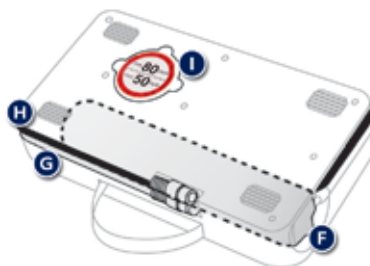

- F. Sealant cartridge.
- G. White pipe with cap for repair.
- H. Black pipe for inflation.
- I. Speed limit sticker.

i The speed limit sticker I must be affixed to the vehicle's steering wheel to remind you that a wheel is in temporary use. Do not exceed a speed of 50 mph (80 km/h) when driving with a tyre repaired using this type of kit.

Repair procedure

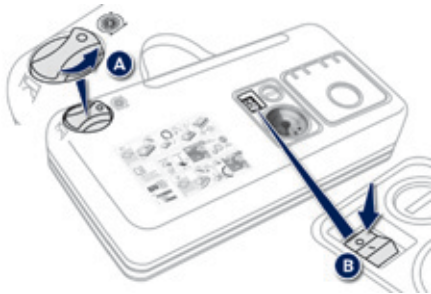

1. Sealing

- ☞ Switch off the ignition.
- ☞ Turn the selector **A** to the "sealant" position.
- ☞ Check that the switch **B** is in position "O".



i Avoid removing any foreign bodies which have penetrated into the tyre.

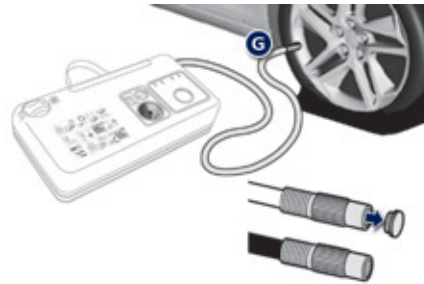

- ☞ Uncoil the white pipe **G** fully.
- ☞ Unscrew the cap from the white pipe.
- ☞ Connect the white pipe to the valve of the tyre to be repaired.

! Take care, this product is harmful (e.g. ethylene-glycol, colophony...) if swallowed and causes irritation to the eyes. Keep this product out of the reach of children.



- ☞ Connect the compressor's electric plug to the vehicle's 12 V socket.
- ☞ Start the vehicle and leave the engine running.

! Do not start the compressor before connecting the white pipe to the tyre valve: the sealant product would be expelled through the pipe.

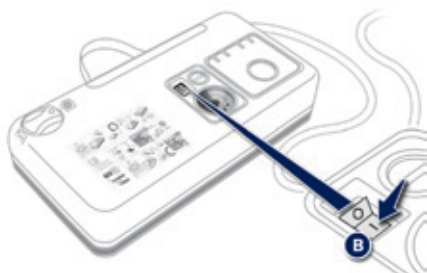

- ☞ Switch on the compressor by moving the switch **B** to position "I" until the tyre pressure reaches 2.0 bars. The sealant is injected into the tyre under pressure; do not disconnect the pipe from the valve during this operation (risk of splashing).

i If after around 5 to 7 minutes the pressure is not attained, this indicates that the tyre is not repairable; contact a PEUGEOT dealer or a qualified workshop for assistance.

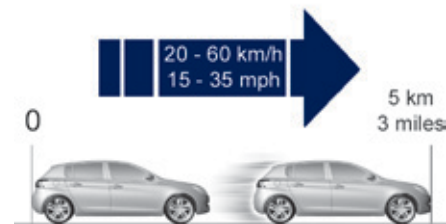

- ☞ Remove the kit and screw the cap back on the white pipe.
- ☞ Take care to avoid staining your vehicle with traces of fluid. Keep the kit to hand.
- ☞ Drive immediately for approximately three miles (five kilometres), at reduced speed (between 15 and 35 mph (20 and 60 km/h)), to plug the puncture.
- ☞ Stop to check the repair and the tyre pressure using the kit.



2. Inflation

- ☞ Turn the selector **A** to the "air" position.
- ☞ Uncoil the black pipe **H** fully.
- ☞ Connect the black pipe to the valve of the wheel.



- ☞ Connect the compressor's electric plug to the vehicle's 12 V socket.
- ☞ Start the vehicle again and leave the engine running.



As soon as possible, go to a PEUGEOT dealer or a qualified workshop. You must inform the technician that you have used this kit. After inspection, the technician will advise you on whether the tyre can be repaired or if it must be replaced.

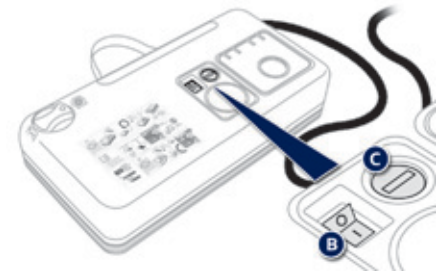

- ☞ Adjust the pressure using the compressor (to inflate: switch **B** in position "I"; to deflate: switch **B** in position "O" and press button **C**), in accordance with the vehicle's tyre pressure label (located on the left hand door aperture).
- A loss of pressure indicates that the puncture has not been fully plugged; contact a PEUGEOT dealer or qualified workshop for assistance.
- ☞ Remove and stow the kit.
 - ☞ Drive at reduced speed (50 mph [80 km/h] max) limiting the distance travelled to approximately 120 miles (200 km).

Removing the cartridge



- ☞ Stow the black pipe.
- ☞ Detach the angled base from the white pipe.
- ☞ Support the compressor vertically.
- ☞ Unscrew the cartridge from the bottom.

! Beware of discharges of fluid.
The expiry date of the fluid is indicated on the cartridge.
The sealant cartridge is designed for single use; even if only partly used, it must be replaced.
After use, do not discard the cartridge into the environment, take it to an authorised waste disposal site or a PEUGEOT dealer.
Do not forget to obtain a new sealant cartridge, available from PEUGEOT dealers or from a qualified workshop.

Checking tyre pressures / inflating accessories



You can also use the compressor, without injecting any product, to:

- check or adjust the pressure of your tyres,
- inflate other accessories (balls, bicycle tyres...).

- ☞ Turn the selector **A** to the "Air" position.
 - ☞ Uncoil the black pipe **H** fully.
 - ☞ Connect the black pipe to the valve of the wheel or accessory.
- If necessary, fit one of the adaptors supplied with the kit first.



- ☞ Connect the compressor's electrical connector to the vehicle's 12 V socket.
- ☞ Start the vehicle and let the engine run.
- ☞ Adjust the pressure using the compressor (to inflate: switch **B** in position "I"; to deflate: switch **B** in position "O" and press button **C**), according to the vehicle's tyre pressure label or the accessory's pressure label.
- ☞ Remove the kit then stow it.

Changing a wheel

Procedure for changing a faulty wheel for the spare wheel using the tools provided with the vehicle.

Access to the tools



The tools are installed in the boot under the floor.

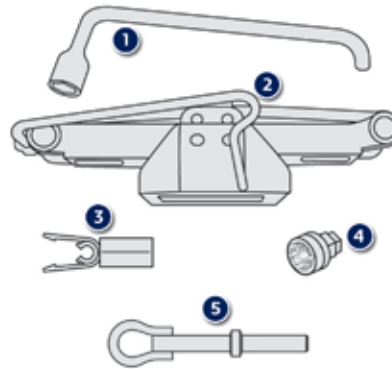

3. "Bolt cover" tool.
For removing the bolt protectors (covers) on alloy wheels.
4. Socket for the security bolts (located in the glove box).
For adapting the wheelbrace to the special "security" bolts.
5. Towing eye.
See "Towing the vehicle".

List of tools

These tools are specific to your vehicle and can vary according to the level of equipment. Do not use them for other purposes.

1. Wheelbrace.
For removing the wheel trim and removing the wheel bolts.
2. Jack with integral handle.
For raising the vehicle.

i Wheel with trim

When refitting the wheel, refit the trim starting by placing its notch facing the valve and press around its edge with the palm of your hand.

Access to the spare wheel

The spare wheel is located in the boot under the floor.

According to country, the spare wheel may be steel, alloy or of the "space-saver" type.

To gain access to it, refer to the "Access to the tools" section.

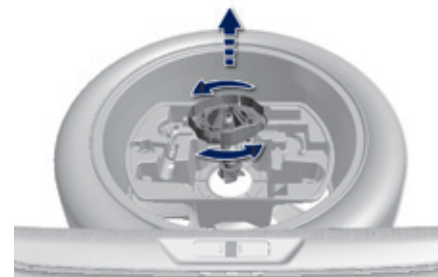

Taking out the wheel

- ☞ Unscrew the (coloured) central bolt.
- ☞ Raise the spare wheel towards you from the rear.
- ☞ Take the wheel out of the boot.

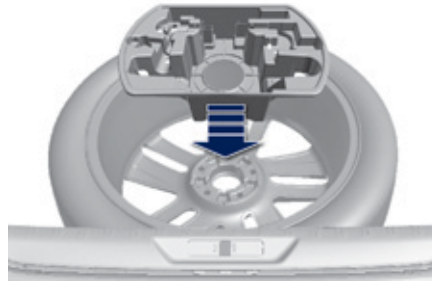
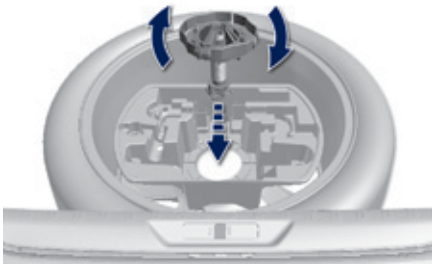

Putting the wheel back in place

- ☞ Put the wheel back in its housing.
- ☞ Unscrew the (coloured) central bolt by a few turns then put it in place in the centre of the wheel.
- ☞ Tighten fully until the central bolt clicks to retain the wheel correctly.
- ☞ Put the box back in place in the centre of the wheel and clip it.
- ☞ Put the polystyrene storage box back in place.

Removing a wheel

i Parking the vehicle

Immobilise the vehicle where it does not block traffic: the ground must be level, stable and not slippery.

Apply the parking brake unless it has been programmed to automatic mode, switch off the ignition and engage first gear to block the wheels.

Check that the braking warning lamp and the **P** warning lamp in the parking brake control lever come on.

The occupants must get out of the vehicle and wait where they are safe. Never go underneath a vehicle raised using a jack; use an axle stand.

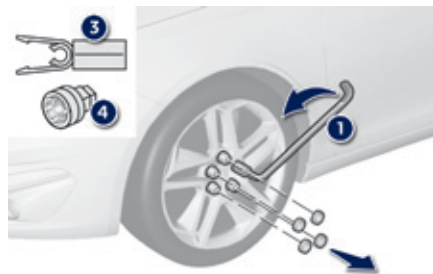

List of operations

- ☞ Remove the bolt cover from each of the bolts using the tool **3** (according to equipment).
- ☞ Fit the security socket **4** on the wheelbrace **1** to slacken the security bolt (if fitted).
- ☞ Slacken the other bolts using the wheelbrace **1** only.



- ☞ Position the foot of the jack on the ground, ensuring that it is directly below the jacking point **A** or **B** used.



- ☞ Extend the jack **2** until its head comes into contact with **A** or **B** (the head of the jack positioned centrally on contact surface of the jacking point on the body).



- ☞ Raise the vehicle until there is sufficient space between the wheel and the ground to admit the spare (not punctured) wheel easily.
- ☞ Remove the bolts and store them in a clean place.
- ☞ Remove the wheel.

Fitting a wheel

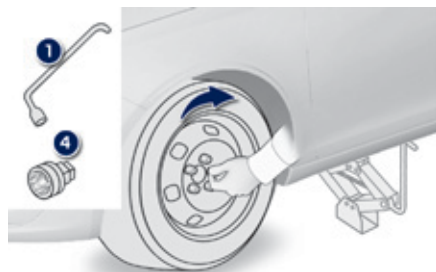

i Fitting the "space-saver" spare wheel

If your vehicle is fitted with alloy wheels, when tightening the bolts on fitting, it is normal to notice that the washers do not come into contact with the "space-saver" spare wheel. The wheel is secured by the conical surface of each bolt.

List of operations

- ☞ Put the wheel in place on the hub.
- ☞ Screw in the bolts fully by hand.
- ☞ Pre-tighten the security bolt using the wheelbrace 1 fitted with the security socket 4 (according to equipment).
- ☞ Pre-tighten the other bolts using the wheelbrace 1 only.
- ☞ Lower the vehicle fully.
- ☞ Fold the jack 2 and detach it.

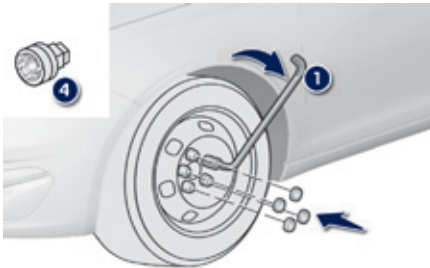

- ☞ Tighten the security bolt using the wheelbrace **1** fitted with the security socket **4** (according to equipment).
- ☞ Tighten the other bolts using the wheelbrace **1** only.
- ☞ Refit the bolt covers on each of the bolts (according to equipment).
- ☞ Store the tools in the box.

i After changing a wheel

To store the punctured wheel in the boot correctly, first remove the central cover. When using the "space-saver" type spare wheel, do not exceed 50 mph (80 km/h).

Have the tightening of the bolts and the pressure of the spare wheel checked by a PEUGEOT dealer or a qualified workshop without delay.

Have the punctured wheel repaired and refitted to the vehicle as soon as possible.

If your vehicle has tyre under-inflation detection, check the tyre pressures then refer to the corresponding section.

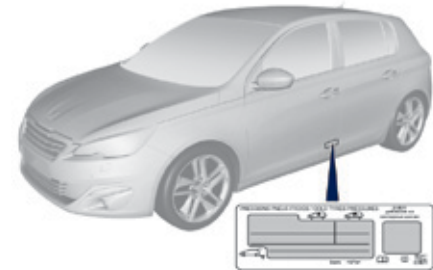

The tyre inflation pressures are given on this label.

Snow chains

In wintry conditions, snow chains improve traction as well as the behaviour of the vehicle when braking.

i The snow chains must be fitted only to the front wheels. They must never be fitted to "space-saver" type spare wheels.





Use only the chains designed to be fitted to the type of wheel fitted to your vehicle:

Original tyre size	Type of chain.
195/65 R15	9 mm links
205/55 R16	
225/45 R17	
225/40 R18	K-Summit K23

You can also use non-slip tyre covers. For more information on snow chains, contact a PEUGEOT dealer or a qualified workshop.

i Take account of the legislation in force in your country on the use of snow chains and the maximum running speed authorised.

Advice on installation

-  If you have to fit the chains during a journey, stop the vehicle on a flat surface on the side of the road.
-  Apply the parking brake and position any wheel chocks to prevent movement of your vehicle.
-  Fit the chains following the instructions provided by the manufacturer.
-  Move off gently and drive for a few moments, without exceeding 30 mph (50 km/h).
-  Stop your vehicle and check that the snow chains are correctly tightened.

i Avoid driving on roads that have been cleared of snow, to avoid damaging your vehicle's tyres and the road surface. It is recommended that before you leave, you practise fitting the snow chains on a level and dry surface. If your vehicle is fitted with alloy wheels, check that no part of the chain or its fixings is in contact with the wheel rim.

Changing a bulb

Front lamps



Model with halogen headlamps

1. Dipped beam headlamps (H7-55W).
2. Main beam headlamps (HB3).
3. Direction indicators (PY21-21W).
4. Daytime running lamps / sidelamps (light emitting diodes - LEDs).

For H7 type bulbs with lugs... take care to observe their correct installation so as to ensure the best lighting performance.



Model with "full LED" technology headlamps

1. Daytime running lamps / sidelamps (light emitting diodes - LEDs).
2. Dipped beam headlamps (light emitting diodes - full LEDs).
3. Main beam headlamps (light emitting diodes - full LEDs).
4. Direction indicators (PY21-21W).



Front fog lamps (H11)

! The headlamps are fitted with polycarbonate glass with a protective coating:

- ☞ **do not clean them using a dry or abrasive cloth, nor with a detergent or solvent product,**
- ☞ use a sponge and soapy water or a pH neutral product,
- ☞ when using a high pressure washer on persistent marks, do not keep the lance directed towards the lamps or their edges for too long, so as not to damage their protective coating and seals.

Changing a bulb should only be done after the headlamp has been switched off for a few minutes (risk of serious burns).

- ☞ Do not touch the bulb directly with your fingers, use a lint-free cloth.

It is imperative to use only anti-ultraviolet (UV) type bulbs to avoid damaging the headlamp.

Always replace a failed bulb with a new bulb with the same type and specification.

i In some weather conditions (e.g. low temperature or humidity), the presence of misting on the internal surface of the glass of the headlamps and rear lamps is normal; it disappears after the lamps have been on for a few minutes.



Daytime running lamps / sidelamps

For the replacement of this type of LED lamp and lighting guides, contact a PEUGEOT dealer or a qualified workshop.

A replacement kit for the LEDs is available from PEUGEOT dealers.

Tips for removing the headlamp (halogen model)

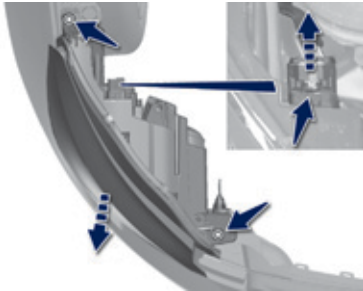

To allow the headlamp to be moved forward a few centimetres for access to the bulbs, proceed as follows:

- ☞ Move the orange clip towards the rear then while pressing on the black part (located above the orange clip) pull on the connector.
- ☞ Remove the two screws holding the lamp.
- ☞ Disengage the rear pin then the front centre piece.
- ☞ Move the lamp forwards.

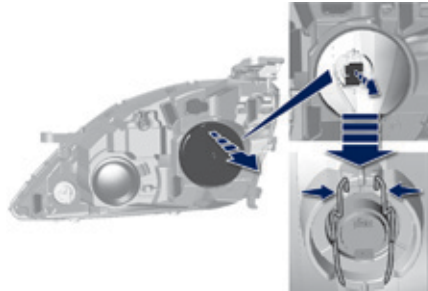

Dipped beam headlamps (halogen model)

- ☞ Remove the protective plastic cover by pulling on the tab.
- ☞ Disconnect the bulb connector.
- ☞ Disengage the two springs (press then move them outwards).
- ☞ Extract the bulb by pulling and change it.

For reassembly, carry out these operations in reverse order.

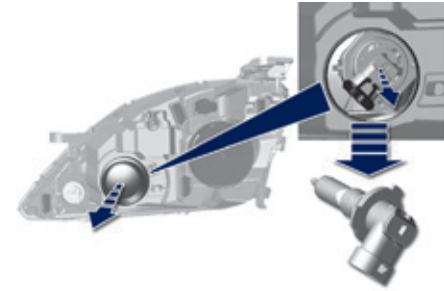

Main beam headlamps (halogen model)

- ☞ Remove the protective plastic cover by pulling on the tab.
- ☞ Turn the connector (with its bulb) towards the top (1/4 turn).
- ☞ Remove the bulb by pulling it out and change it.

For reassembly, carry out these operations in reverse order.

! Be aware that the area behind the right-hand headlamp (facing forwards) may be hot, with the risk of burns (overflow pipe).

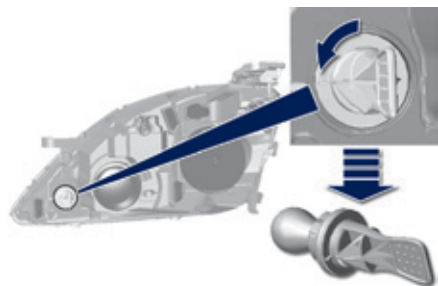

Direction indicators (halogen model)

- ☞ Unscrew the bulb holder (1/4 turn).
- ☞ Remove the bulb holder.
- ☞ Change the failed bulb.

For reassembly, carry out these operations in reverse order.

i Faster flashing of a direction indicator warning lamp (left or right) indicates a failed bulb on that side.



Daytime running lamps / sidelamps ("full LED" technology model)

For the replacement of this type of "full LED" light emitting diode lamps, contact a PEUGEOT dealer or a qualified workshop.

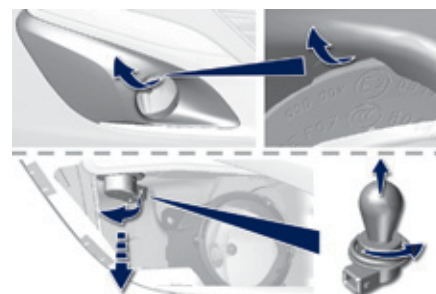

Direction indicators ("full LED" technology model)

i Faster flashing of a direction indicator warning lamp (left or right) indicates a failed bulb on that side.

The direction indicator bulb is located below the front lamp.

- ☞ Unclip the finisher by pulling at the top (cut-out).
- ☞ Unscrew the bulb holder (1/4 turn).
- ☞ Change the failed bulb.

For reassembly, carry out these operations in reverse order.

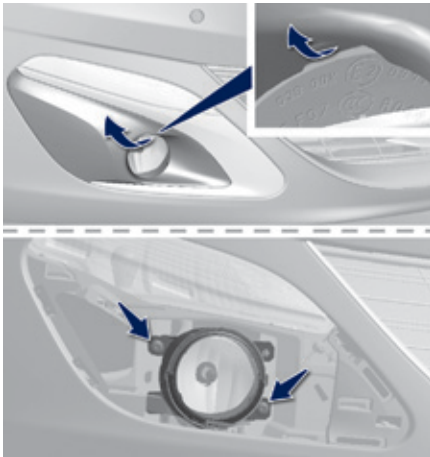

Front foglamps

- ☞ Unclip the finisher by pulling at the top (cut-out).
- ☞ Remove the two screws to remove the unit from its housing.

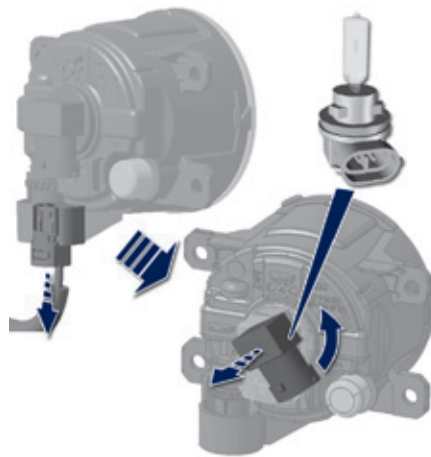

- ☞ Disconnect the connector.
- ☞ Unscrew the bulb holder (1/4 turn).
- ☞ Remove the bulb holder.
- ☞ Change the failed bulb.

For reassembly, carry out these operations in reverse order, pressing on the finisher to refit it.

Door mirror spotlamps



You should contact a PEUGEOT dealer or a qualified workshop for the replacement of the light emitting diode - LED.

Integrated direction indicator side repeaters

You should contact a PEUGEOT dealer or a qualified workshop for the replacement of these bulbs.

Rear lamps (saloon)

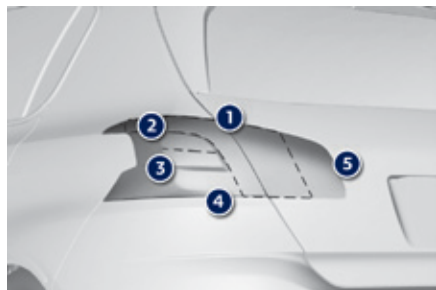

1. Sidelamps (light emitting diodes - LEDs).
2. Reversing lamps (W16W).
3. Direction indicators (PY21W amber).
4. Brake lamps (light emitting diodes - LEDs).
5. Foglamps (P21W).

i Light emitting diodes-LEDs

For replacement, contact a PEUGEOT dealer or qualified workshop.



Reversing lamps, direction indicators (on the wings)

- ☞ Open the tailgate then remove the access cover.

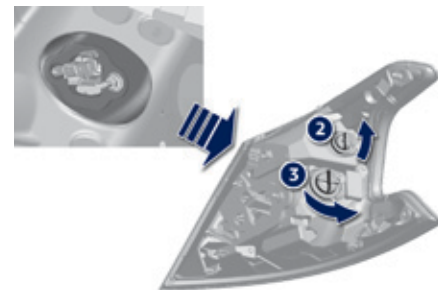

- ☞ Disconnect the lamp connector.
- ☞ Remove the lamp fixing nut.
- ☞ Carefully remove the lamp unit from outside.
- ☞ Unscrew the bulb holder (a quarter of a turn) and change the bulb.

For reassembly, carry out these operations in reverse order.

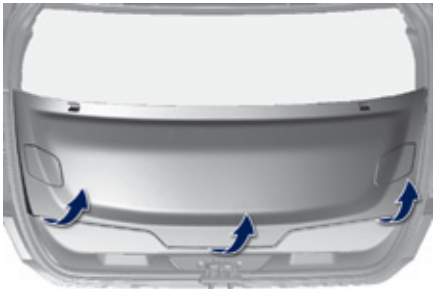

Foglamp (tailgate)

- ☞ Open the tailgate and then remove the large plastic cover



- ☞ Unclip the left and right access covers.
- ☞ Remove the screws located in each opening.
- ☞ Unclip the boot trim for access to the lamp connector.
- ☞ Disconnect the lamp connector.
- ☞ Remove the lamp fixing nut.
- ☞ Carefully remove the lamp from the outside.
- ☞ Unscrew the bulb holder (a quarter of a turn) and change the bulb.

For reassembly, carry out these operations in reverse order.

Rear lamps (SW)

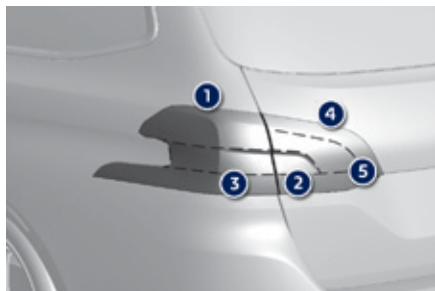

1. Sidelamps (light emitting diodes - LEDs).
2. Direction indicators (PY21W amber).
3. Brake lamps (light emitting diodes - LEDs).
4. Reversing lamps (W16W).
5. Foglamps (P21W).

i Light emitting diodes-LEDs

For replacement, contact a PEUGEOT dealer or qualified workshop.



Direction indicators (on the wings)

- ☞ Open the tailgate then remove the access cover.
- ☞ Remove the two lamp fixing nut (pipe spanner or socket recommended).
- ☞ Disengage the retaining clip, carefully removing the lamp unit from outside.

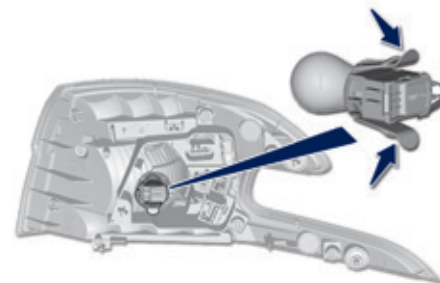

- ☞ Disconnect the lamp connector.
- ☞ Remove the sealing foam.
- ☞ Unclip the bulb holder by pressing on the two tongues.
- ☞ Replace the bulb.

For reassembly, carry out these operations in reverse order.

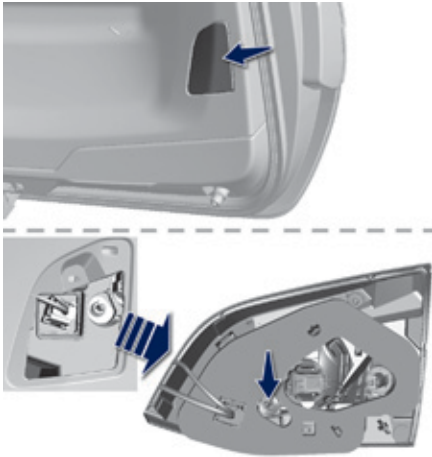

Reversing lamp, rear foglamp (tailgate)

- ☞ Open the tailgate and then remove the access cover.
- ☞ Remove the lamp fixing nut.

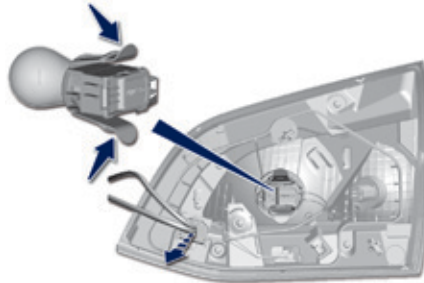

- ☞ Carefully remove the lamp from the outside.
- ☞ Disconnect the lamp connector.
- ☞ Foglamp: unclip the bulb holder by pressing on the two tongues then replace the bulb.
- ☞ Reversing lamp: turn the bulb holder a quarter of a turn then replace the bulb.

For reassembly, carry out these operations in reverse order.



Third brake lamp (light emitting diodes-LED)

For the replacement of this type of lamp, contact a PEUGEOT dealer or a qualified workshop.

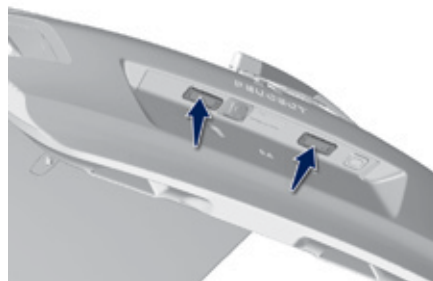

Number plate lamps (W5W)

- ☞ Insert a thin screwdriver into one of the cutouts in the the lens.
- ☞ Push it outwards to unclip it.
- ☞ Remove the lens.
- ☞ Change the faulty bulb.

To refit, press on the lens to clip it in place.

Changing a fuse

Access to the tools

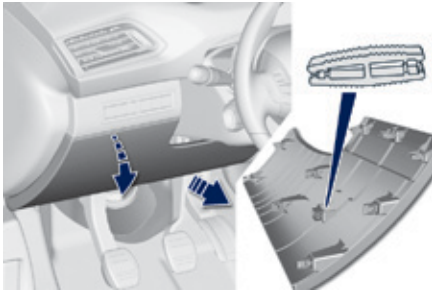

The extraction tweezers are fitted to the back of the dashboard fusebox cover.

- ☞ Unclip the cover by pulling at the top left, then right.
- ☞ Disengage the cover completely and turn it over,
- ☞ Remove the tweezers from the back of the cover to which it is fitted.

Changing a fuse

Before changing a fuse:

- ☞ the cause of the failure must be identified and rectified,
- ☞ all electrical consumers must be switched off,
- ☞ the vehicle must be immobilised with the ignition off,
- ☞ identify the failed fuse using the tables and layout drawings in the following pages.

To replace a fuse, you must:

- ☞ use the special tweezers to extract the fuse from its housing and check the condition of its filament,
- ☞ always replace the failed fuse with a fuse of the same rating (same colour); using a different rating could cause faults (risk of fire).

If the fuse fails again soon after replacement, have the vehicle's electrical system checked by a PEUGEOT dealer or a qualified workshop.

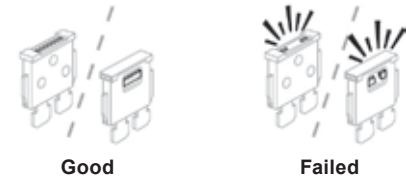

Good

Failed



Tweezer

! The replacement of a fuse not shown in the tables below may cause a serious malfunction of your vehicle. Contact a PEUGEOT dealer or a qualified workshop.

i Installing electrical accessories

Your vehicle's electrical system is designed to operate with standard or optional equipment.

Before installing other electrical equipment or accessories on your vehicle, contact a PEUGEOT dealer or a qualified workshop.

! PEUGEOT will not accept responsibility for the cost incurred in repairing your vehicle or for rectifying malfunctions resulting from the installation of accessories not supplied and not recommended by PEUGEOT and not installed in accordance with its instructions, in particular when the combined consumption of all of the additional equipment connected exceeds 10 milliamperes.

Dashboard fuses



The fusebox is placed in the lower dashboard (left-hand side).

Access to the fuses

- ☞ Unclip the cover by pulling at top left, then right.

Version 1 (FULL)

Fuse N°	Rating (A)	Functions
F15	15	12 V accessory socket.
F16	15	Cigarette lighter.
F17	15	Audio system.
F18	20	Audio system (battery +).

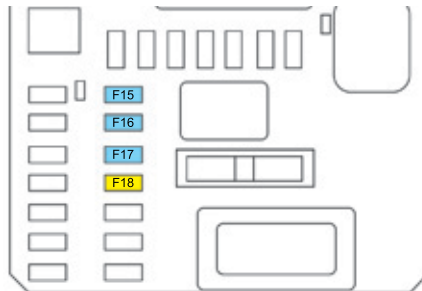

Version 2 (ECO)

Fuse N°	Rating (A)	Functions
F6 A or B	15	Audio system.
F13	10	Cigarette lighter.
F14	10	12 V accessory socket.
F28 A or B	15	Audio system (battery +).

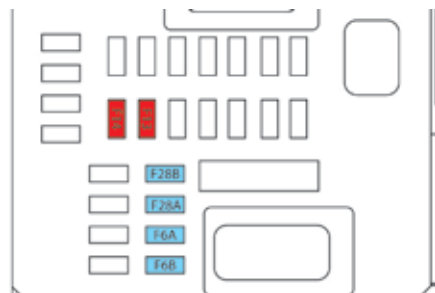

Engine compartment fuses



The fusebox is placed in the engine compartment near the battery.

Access to the fuses

- ☞ Unclip the cover.
- ☞ Change the fuse (see corresponding paragraph).
- ☞ When you have finished, close the cover carefully to ensure correct sealing of the fusebox.

Version 1 (FULL)

Fuse N°	Rating (A)	Functions
F19	30	Front wiper motor.
F20	15	Front and rear screenwash pumps.
F21	20	Headlamp wash.
F22	15	Horn.
F23	15	Right hand main beam headlamp.
F24	15	Left hand main beam headlamp.



Version 2 (ECO)

Fuse N°	Rating (A)	Functions
F16	15	Front foglamps.
F18	10	Right hand main beam headlamp.
F19	10	Left hand main beam headlamp.
F25	40	Headlamp wash relay (aftermarket fitment).
F29	30	Front wiper motor.
F30	80	Pre-heater plugs (Diesel), additional programmable heating (aftermarket fitment), headlamp wash pump.

12 V battery

Procedure for starting the engine using another battery or charging a discharged battery.

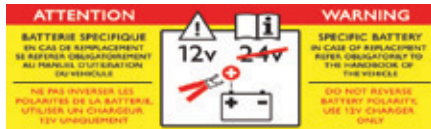

! The presence of this label, in particular with the Stop & Start system, indicates the use of a 12 V lead-acid battery with special technology and specification; the involvement of a PEUGEOT dealer or a qualified workshop is essential when replacing or disconnecting the battery.

i After refitting the battery, the Stop & Start system will only be active after a continuous period of immobilisation of the vehicle, a period which depends on the climatic conditions and the state of charge of the battery (up to about 8 hours).

! Before doing any work

Immobilise the vehicle: apply the parking brake, put the gearbox in neutral, then switch off the ignition. Check that all electrical equipment is switched off.

Access to the battery

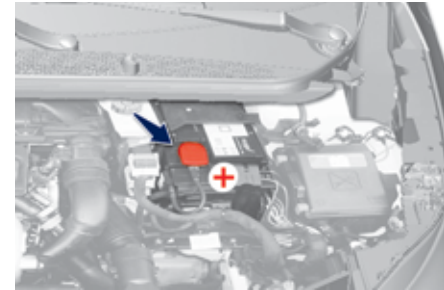

The battery is located under the bonnet.

To gain access to it:

- ☞ open the bonnet using the interior release lever, then the exterior safety catch,
- ☞ secure the bonnet stay,
- ☞ remove the plastic cover on the (+) terminal,
- ☞ if necessary, unclip the fusebox to remove the battery.

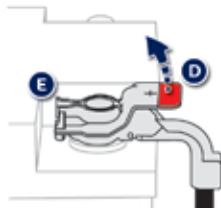

Disconnecting the (+) cable

- ☞ Raise the locking tab **D** fully to release the cable terminal clamp **E**.

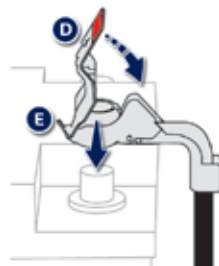

Reconnecting the (+) cable

- ☞ Position the open clamp **E** of the cable on the positive post (+) of the battery.
- ☞ Press vertically on the clamp **E** to position it correctly on the battery.
- ☞ Lock the clamp by spreading the positioning lug and then lowering the tab **D**.

! Do not apply excessive force on the tab as locking will not be possible if the clamp is not positioned correctly; start the procedure again.

Starting using another battery

When your vehicle's battery is discharged, the engine can be started using a slave battery (external or on another vehicle) and jump lead cables.

- ! First check that the slave battery has a nominal voltage of 12 V and a capacity at least equal to that of the discharged battery.
Do not try to start the engine by connecting a battery charger.
Do not disconnect the (+) terminal when the engine is running.

- ☞ Remove the plastic cover from the (+) terminal, if your vehicle has one.
- ☞ Connect the red cable to the positive terminal (+) of the flat battery **A**, then to the positive terminal (+) of the slave battery **B**.
- ☞ Connect one end of the green or black cable to the negative terminal (-) of the slave battery **B** (or earth point on the other vehicle).
- ☞ Connect the other end of the green or black cable to the earth point **C** on the broken down vehicle (or on the engine mounting).
- ☞ Start the engine of the vehicle with the good battery and leave it running for a few minutes.

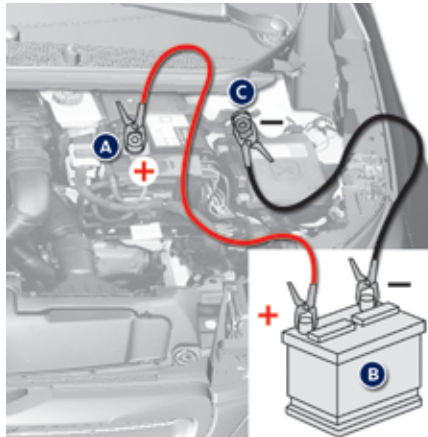

- ☞ Operate the starter on the broken down vehicle and let the engine run
If the engine does not start straight away, switch off the ignition and wait a few moments before trying again.
- ☞ Wait until the engine returns to idle then disconnect the jump lead cables in the reverse order.
- ☞ Refit the plastic cover to the (+) terminal, if your vehicle has one.

i Some functions are not available if the battery is not sufficiently charged.

Before disconnecting the battery

Wait 2 minutes after switching off the ignition before disconnecting the battery.
Close the windows and the doors before disconnecting the battery.

Following reconnection of the battery

Following reconnection of the battery, switch on the ignition and wait 1 minute before starting to permit initialisation of the electronic systems. However, if problems remain following this operation, contact a PEUGEOT dealer or a qualified workshop.

Referring to the corresponding section, you must yourself reinitialise (depending on version):

- the remote control key,
- the electric blind(s),
- ...

Charging the battery using a battery charger

i With Stop & Start, the battery does not have to be disconnected for charging.

- ☞ Disconnect the battery from the vehicle.
- ☞ Follow the instructions for use provided by the manufacturer of the charger.
- ☞ Connect the battery starting with the negative terminal (-).
- ☞ Check that the terminals and connectors are clean. If they are covered with sulphate (whitish or greenish deposit), remove them and clean them.



The batteries contain harmful substances such as sulphuric acid and lead. They must be disposed of in accordance with regulations and must not, in any circumstances, be discarded with household waste.

Take used remote control batteries and vehicle batteries to a special collection point.



It is advisable to disconnect the battery if the vehicle is to be left unused for more than one month.



Protect your eyes and face before handling the battery. All operations on the battery must be carried out in a well ventilated area and away from naked flames and sources of sparks, so as to avoid the risk of explosion or fire. Do not try to charge a frozen battery; the battery must first be thawed out to avoid the risk of explosion. If the battery has been frozen, before charging have it checked by a PEUGEOT dealer or a qualified workshop who will check that the internal components have not been damaged and the casing is not cracked, which could cause a leak of toxic and corrosive acid. Do not reverse the polarity and use only a 12 V charger. Do not disconnect the terminals while the engine is running. Do not charge the batteries without disconnecting the terminals first. Wash your hands afterwards.

Load reduction mode

System which manages the use of certain functions according to the level of charge remaining in the battery.

When the vehicle is being driven, the load reduction function temporarily deactivates certain functions, such as the air conditioning, the heated rear screen...

The deactivated functions are reactivated automatically as soon as conditions permit.

Energy economy mode

System which manages the duration of use of certain functions to conserve a sufficient level of charge in the battery.

After the engine has stopped, you can still use functions such as the audio and telematics system, windscreen wipers, dipped beam headlamps, courtesy lamps, etc. for a maximum combined duration of about forty minutes.

Switching to economy mode

A message then appears in the instrument panel screen indicating that the vehicle has switched to economy mode and the active functions are put on standby.

If a telephone call is being made at this time, it will be maintained for around 10 minutes with the Bluetooth hands-free system of your audio system.

Exiting economy mode

These functions are reactivated automatically next time the vehicle is driven.

In order to restore the use of these functions immediately, start the engine and let it run:

- for less than ten minutes, to use the equipment for approximately five minutes,
- for more than ten minutes, to use the equipment for up to approximately thirty minutes.

Let the engine run for the duration specified to ensure that the battery charge is sufficient.

Do not repeatedly and continuously restart the engine in order to charge the battery.

A flat battery prevents the engine from starting (refer to the "Battery" section).

Changing a wiper blade



Before removing a front wiper blade

- ☞ Within one minute after switching off the ignition, operate the wiper stalk to position the wiper blades vertically on the windscreen.

Removing

- ☞ Raise the corresponding wiper arm.
- ☞ Unclip the wiper blade and remove it.

Fitting

- ☞ Put the corresponding new wiper blade in place and clip it.
- ☞ Fold down the wiper arm carefully.

After fitting a front wiper blade

- ☞ Switch on the ignition.
- ☞ Operate the wiper stalk again to park the wiper blades.

Towing the vehicle

Procedure for having your vehicle towed or for towing another vehicle using a removable towing eye.

Access to the tools

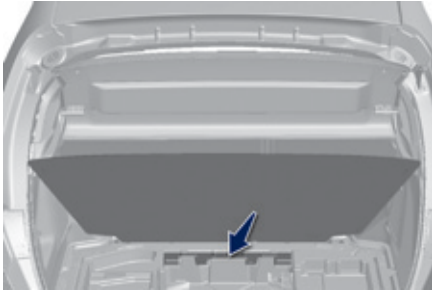

The towing eye is installed in the boot under the floor.

To gain access to it:

- ☞ open the boot,
- ☞ raise the floor,
- ☞ remove the towing eye from the holder.

From the front

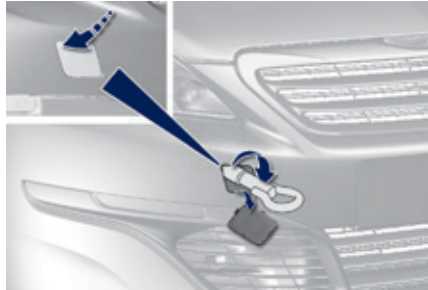

- ☞ On the front bumper, press the cover (as shown above) to unclip it.
- ☞ Screw the towing eye in fully.
- ☞ Install the towing bar.
- ☞ Switch on the hazard warning lamps on the towed vehicle.
- ☞ Move off gently and drive slowly over a short distance only.

- i** Put the gear lever into neutral. The failure to follow this requirement may lead to damage to components of the braking system and the lack of braking assistance on restarting the engine.

From the rear

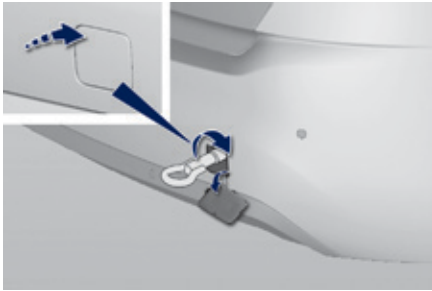

- ☞ On the rear bumper, press the cover (as shown above) to unclip it.
- ☞ Screw the towing eye in fully.
- ☞ Install the towing bar.
- ☞ Switch on the hazard warning lamps on the towed vehicle.
- ☞ Move off gently and drive slowly over a short distance only.

! General recommendations

Observe the legislation in force in your country.

Ensure that the weight of the towing vehicle is higher than that of the towed vehicle.

The driver must remain at the wheel of the towed vehicle and must have a valid driving licence.

When towing a vehicle with all four wheels on the ground, always use an approved towing bar; rope and straps are prohibited.

The towing vehicle must move off gently.

When towing a vehicle with the engine off, there is no longer any power assistance for braking or steering.

In the following cases, you must always call on a professional recovery service:

- vehicle broken down on a motorway or fast road,
- four-wheel drive vehicle,
- when it is not possible to put the gearbox into neutral, unlock the steering, or release the parking brake,
- towing with only two wheels on the ground,
- where there is no approved towing bar available...

Very cold climate screen

Removable protective screen which prevents the accumulation of snow at the radiator cooling fan.

! Before fitting or removing the screen, ensure that the engine is off and the cooling fan has stopped. It is recommended that the screen be fitted and removed by a PEUGEOT dealer or a qualified workshop.



Fitting

- ☞ Offer up the screen to the front of the top section of the front bumper upper grille.
- ☞ Press on the screen to engage its fixing clips.

Removal

- ☞ Use a screwdriver as a lever to unclip each retaining clip in turn.

- !** Do not forget to remove the very cold climate screen:
- when the ambient temperature exceeds 10° C (for example: in summer, ...),
 - when towing,
 - at speeds above 75 mph (120 km/h).

Towing a trailer



Towbar suitable for the attachment of a trailer or installation of a bicycle carrier, with additional lighting and signalling.

Your vehicle is primarily designed for transporting people and luggage, but it may also be used for towing a trailer.

Blanking cover



When towing, you must remove the blanking cover if your vehicle has one. Contact a PEUGEOT dealer or a qualified workshop for this.

i The cover is located behind the lower air intake grille.

i We recommend the use of genuine PEUGEOT towbars and their harnesses that have been tested and approved from the design stage of your vehicle, and that the fitting of the towbar is entrusted to a PEUGEOT dealer or a qualified workshop. If the towbar is not fitted by a PEUGEOT dealer, it is imperative that it is fitted in accordance with the vehicle manufacturer's instructions.

! Driving with a trailer places greater demands on the towing vehicle and the driver must take particular care.

Driving advice

Distribution of loads

- ☞ Distribute the load in the trailer so that the heaviest items are as close as possible to the axle and the nose weight approaches the maximum permitted without exceeding it.

Air density decreases with altitude, thus reducing engine performance. Above 1 000 metres, the maximum towed load must be reduced by 10 % for every 1 000 metres of altitude.

- i** Refer to the "Technical data" section for details of the weights and towed loads which apply to your vehicle.

Side wind

- ☞ Take into account the increased sensitivity to side wind.

Cooling

Towing a trailer on a slope increases the temperature of the coolant.

As the fan is electrically controlled, its cooling capacity is not dependent on the engine speed.

- ☞ To lower the engine speed, reduce your speed.

The maximum towed load on a long incline depends on the gradient and the ambient temperature.

In all cases, keep a check on the coolant temperature.



- ☞ If the warning lamp and the **STOP** warning lamp come on, stop the vehicle and switch off the engine as soon as possible.

Braking

Towing a trailer increases the braking distance. To avoid overheating of the brakes on a long mountain type of descent, the use of engine braking is recommended.

Tyres

- ☞ Check the tyre pressures of the towing vehicle and of the trailer, observing the recommended pressures.

Lighting

- ☞ Check the electrical lighting and signalling on the trailer.

- i** The rear parking sensors will be deactivated automatically if a genuine PEUGEOT towbar is used.

Fitting roof bars

When fitting transverse roof bars, take care to position them correctly on the retaining pins located in the door apertures.

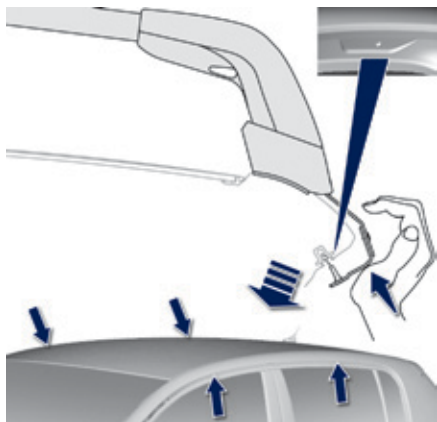

! Use accessories recommended by PEUGEOT observing the manufacturer's recommendations and fitting instructions so as to avoid the risk of damaging the body (deformation, scratches, ...).

i Do not exceed the maximum authorised load, shown in the instructions for the roof bars.

If the height exceeds 40 cm, adapt the speed of the vehicle to the profile of the road to avoid damaging the roof bars and the fixings on the roof.

Be sure to refer to national legislation in order to comply with the regulations for transporting objects which are longer than the vehicle.

With longitudinal bars

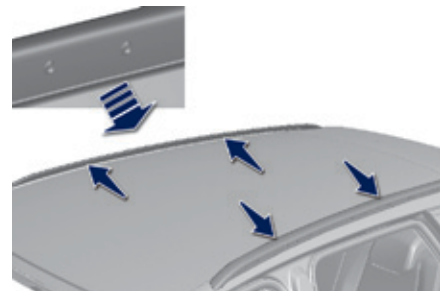

You must fit the transverse bars to the longitudinal bars at the fixing points indicated by engraved markings on the longitudinal bars.

Bicycle / accessory carrier

Recommendations

- For safety reasons and to avoid damaging the roof, it is essential to use the transverse bars listed for your vehicle.
- Distribute the load evenly, avoiding overloading on one side.
- Arrange the heaviest part of the load as close as possible to the roof.
- Anchor the load securely and fit a warning flag if part of it overhangs the vehicle.
- Drive gently, as the vehicle will be more susceptible to the effects of side winds (vehicle stability may be affected).
- Remove the roof bars as soon as they are no longer needed.



i Do not fit an accessory carrier to the tailgate.

Accessories

A wide range of accessories and genuine parts is available from the PEUGEOT dealer network. These accessories and parts have been tested and approved for reliability and safety. They are all adapted to your vehicle and benefit from PEUGEOT's recommendation and warranty.

Conversion kits

You can obtain an "Enterprise" kit to convert a trade vehicle to a private car and vice-versa.

"Transport solutions"

Boot liners, roof bars, bicycle carrier on roof bars, ski carrier, roof box, towbar harness, ...
Tow bar, which must be fitted by PEUGEOT dealer or a qualified workshop.

"Security and safety"

Anti-theft alarm, window engraving, wheel security bolts, child seats and booster cushions, breathalyzer, first aid kit, warning triangle, high visibility jacket, stolen vehicle tracking system, temporary puncture repair kit, snow chains, non-slip covers, front foglamps kit, dog guard, ...

"Comfort"

Door deflectors, side blinds and rear blind, cigarette lighter, boot dividers, coat hanger fixed to head restraint, front centre armrest, under shelf storage, front and rear parking sensors, styling mudflaps, window film, boot management system, ...

"Styling"

alloy wheels from 15 inch to 18 inch, finishers for wheels, door sills, gear lever knobs, ...
"Ligne S": 16 and 17 inch alloy wheels, body kit, stickers, interior and exterior mirror shells, gear lever knob, door sills, mats*, ...

"Protection"

Mats*, seat covers compatible with lateral airbags, mud flaps, side protection rubbing strips, bumper protection rubbing strips, bumper protectors, boot sill finishers, boot mat, ...

- * To avoid any risk of jamming of the pedals:
- ensure that the mat is positioned and secured correctly,
 - never fit one mat on top of another.

"Multimedia"

Multimedia support, hands-free kit, DVD player, driving aids, vehicle tracking system, ...

By visiting a PEUGEOT dealer, you can also obtain products for cleaning and maintenance (exterior and interior) - including ecological products in the "TECHNATURE" range, topping up products (screenwash...), touch-up pens and paint aerosols for the exact colour of your vehicle, refills (cartridge for the temporary puncture repair kit...), ...

i Installation of radio communication transmitters

Before installing any after-market radio communication transmitter, you can contact a PEUGEOT dealer for the specification of transmitters which can be fitted (frequency, maximum power, aerial position, specific installation requirements), in line with the Vehicle Electromagnetic Compatibility Directive (2004/104/EC).

i Depending on the legislation in force in the country, certain safety equipment may be compulsory: high visibility safety vests, warning triangles, breathalyzers, spare bulbs, spare fuses, a fire extinguisher, a first aid kit, mud flaps at the rear of the vehicle.

! The fitting of electrical equipment or accessories which are not recommended by PEUGEOT may result in a failure of your vehicle's electronic system and excessive electrical consumption.
Please note this precaution. You are advised to contact a PEUGEOT representative to be shown the range of recommended equipment and accessories.

PEUGEOT & TOTAL

Partners in performance and protection of the environment

Innovation at the service of performance

The TOTAL Research and Development teams develop lubricants for PEUGEOT which satisfy the requirements of the latest technical innovations incorporated in PEUGEOT vehicles.

This ensures that you obtain the best performance and the maximum engine life.

Reduced exhaust emissions

TOTAL lubricants are formulated to optimise the efficiency of engines and the protection of the emissions post-treatment systems. It is crucial to observe the servicing recommendations made by PEUGEOT to ensure correct operation.



PEUGEOT RECOMMENDS TOTAL



OFFICIAL PARTNERS

Bonnet

- ! Before doing anything under the bonnet, switch off the Stop & Start system to avoid any risk of injury resulting from an automatic change to START mode.



Opening

- ☞ Open the door.
- ☞ Pull the release lever, located at the bottom of the door aperture, towards you.



- ☞ Pull the safety catch towards you, then raise the bonnet.

- ! Do not open the bonnet under very windy conditions. When the engine is hot, handle the exterior safety catch and the stay with care (risk of burns). To avoid damaging electrical units, it is strictly **forbidden** to use a high pressure jet wash under the bonnet.



- ☞ Unclip the stay from its housing and place it in the support slot to hold the bonnet open.

Closing

- ☞ Take the stay out of its support slot.
- ☞ Clip the stay back into its housing.
- ☞ Lower the bonnet and release it at the end of its travel.
- ☞ Pull on the bonnet to check that it has latched correctly.

Petrol engine

The various caps and covers allow access for checking the levels of the various fluids and for replacing certain components.

1. Screenwash and headlamp wash reservoir.
2. Coolant reservoir.
3. Brake fluid filler.
4. Battery / Fuses.
5. Fusebox.
6. Air filter.
7. Engine oil dipstick.
8. Engine oil filler cap.

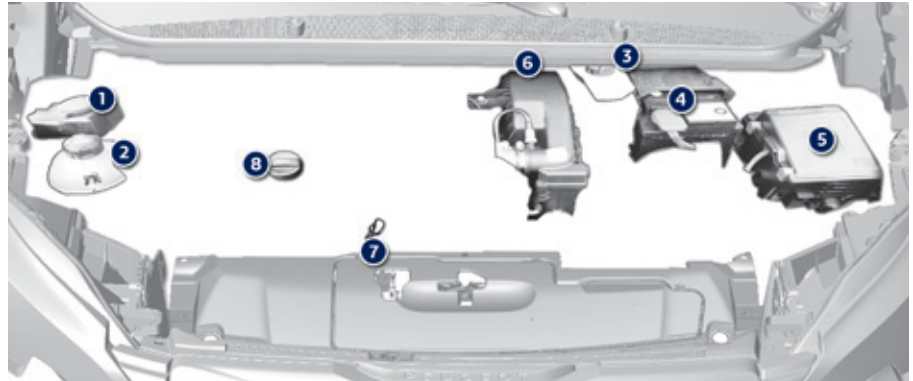

This engine is shown as an example. The locations of the engine oil dipstick and filler cap may vary.

Diesel engine

The various caps and covers allow access for checking the levels of the various fluids, for replacing certain components and for priming the fuel system.

1. Screenwash and headlamp wash reservoir.
2. Coolant reservoir.
3. Brake fluid filler.
4. Battery / Fuses.
5. Fusebox.
6. Air filter.
7. Engine oil dipstick.
8. Engine oil filler cap.
9. Priming pump*.

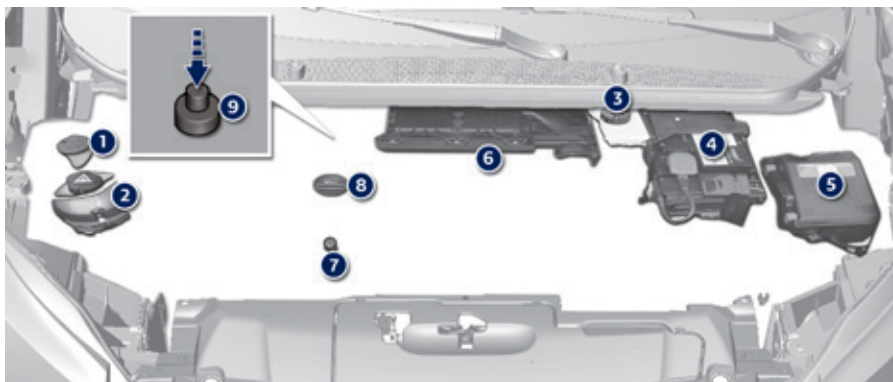

This engine is shown as an example. The locations of the engine oil dipstick and filler cap may vary.

* According to engine.

Running out of fuel (Diesel)

On vehicles fitted with HDi engines, the fuel system must be primed if you run out of fuel; refer to the corresponding engine compartment view.

1.6 litre HDi engine



i If the tank on your vehicle is fitted with a misfuel prevention device, refer to the "Misfuel prevention (Diesel)" section.

! If the engine does not start first time, don't keep trying but start the procedure again from the beginning.

- ☞ Fill the fuel tank with at least five litres of diesel.
- ☞ Open the bonnet.
- ☞ If necessary, unclip the styling cover for access to the priming pump.
- ☞ Squeeze and release the priming pump repeatedly until resistance is felt (there may be resistance at the first press).
- ☞ Operate the starter until the engine starts (if the engine does not start at the first attempt, wait around 15 seconds before trying again).
- ☞ If the engine does not start after a few attempts, operate the priming pump again then start the engine.
- ☞ Clip the styling cover back in place.
- ☞ Close the bonnet.

AdBlue® additive and SCR system for Blue HDi Diesel engines

To assure respect for the environment and conformity with the new Euro 6 emissions standard, without adversely affecting the performance or fuel consumption of Diesel engines, PEUGEOT has taken the decision to equip its vehicles with an effective system that associates SCR (Selective Catalytic Reduction) with a particle emissions filter (PEF) for the treatment of exhaust gases.

Presentation of the SCR system

Using an additive called AdBlue® containing urea, a catalytic converter turns up to 85% of nitrous oxides (NOx) into nitrogen and water, which are harmless to health and the environment.

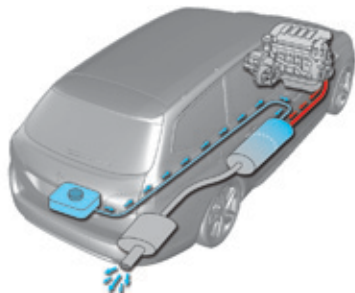

The AdBlue® additive is held in a special tank located under the boot at the rear of the vehicle. It has a capacity of 17 litres: this provides a driving range of about 12 500 miles (20 000 km), after which an alert is triggered warning you when the reserve remaining is enough for just 1 500 miles (2 400 km).

During each scheduled service of your vehicle by a PEUGEOT dealer or a qualified workshop, the AdBlue® additive tank is refilled in order to allow normal operation of the SCR system.

If the estimated mileage between two services is greater than 12 500 miles (20 000 km), we recommend that you go to a dealer to have the necessary top-up carried out.

! Once the AdBlue® tank is empty, a system required by regulations prevents starting of the engine. If the SCR is faulty, the level of emissions from your vehicle will longer meet the Euro 6 standard: you vehicle becomes polluting. In the event of a confirmed fault with the SCR system, you must go to a PEUGEOT dealer or a qualified workshop as soon as possible: after a running distance of 680 miles (1 100 km), a system will be triggered automatically to prevent engine starting.

Range indicators

When switching on the ignition, an indicator gives an estimate of the distance that can be travelled with your vehicle before engine starting is automatically prevented, once the vehicle starts using the reserve of AdBlue® or after a fault is detected with the SCR system. In the event of simultaneous system fault and low AdBlue® level, the shortest range is the one displayed.

In the event of the risk of non-starting related to a lack of AdBlue®

! The engine start prevention system required by regulations is activated automatically once the AdBlue® tank is empty.

Remaining range greater than 1 500 miles (2 400 km)

When switching on the ignition, there is no automatic display of range in the instrument panel.



Pressing this button will display the remaining range.

You can access this information in the touch screen, if your vehicle has one.



☞ Select the "Driving assistance" menu.



☞ Then select "Diagnostic".

CHECK

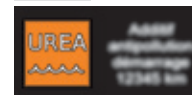

The range at that moment is then displayed.

Above 3 000 miles (5 000 km), the value is not specified.

Remaining range between 350 and 1500 miles (600 and 2 400 km)



When switching on the ignition, the UREA warning lamp comes on, accompanied by an audible signal and the display of a message (e.g.: "Top up emissions additive: Starting prevented in 900 miles") indicating the remaining range expressed in miles or kilometres.

When driving, the message is displayed every 150 miles (300 km) until the additive tank has been topped-up.

Go to a PEUGEOT dealer or a qualified workshop to have the AdBlue® tank topped-up. You can also top-up the tank yourself. Refer to the "Topping-up" section.

Remaining range between 0 and 350 miles (0 and 600 km)



When switching on the ignition, the SERVICE warning lamp comes on and the UREA warning lamp flashes, accompanied by an audible signal and the display of a message (e.g. "Top up emissions additive: Starting prevented in 350 miles") indicating the remaining range expressed in miles or kilometres.

When driving, the message is displayed every 30 seconds until the additive tank has been topped-up.

Go to a PEUGEOT dealer or a qualified workshop to have the AdBlue® tank topped-up. You can also top-up the tank yourself. Refer to the "Topping-up" section. If you fail to do this, there is a risk that you will not be able to start your engine.

Breakdown related to a lack of AdBlue® additive



When switching on the ignition, the SERVICE warning lamp comes on and the UREA warning lamp flashes, accompanied by an audible signal and the display of the message "Top up emissions additive: Starting prevented". The AdBlue® tank is empty: the system required by regulations prevents engine starting.

! To be able to start the engine, we recommend that you call on a PEUGEOT dealer or a qualified workshop for the top-up required. If you carry out the top-up yourself, it is essential to add at least 3.8 litres of AdBlue® to the tank. Refer to the "Topping-up" section.

In the event of a fault with the the SCR emissions control system

! A system that prevents engine starting is activated automatically from 650 miles (1 100 km) after confirmation of a fault with the SCR emissions control system. Have the system checked by a PEUGEOT dealer or a qualified workshop as soon as possible.

In the event of the detection of a fault



When switching on the ignition, the UREA, SERVICE and diagnostic warning lamps comes on, accompanied by an audible signal and the display of a message "Emissions fault" to signal a fault with the emissions control system.

i If it is a temporary fault, the alert disappears once the exhaust gas emissions return to normal.

During an authorised driving phase (between 650 miles and 0 miles) (1 100 km and 0 km)



If a fault with the SCR system is confirmed (after 30 miles (50 km) covered with the permanent display of the message signalling a fault), when switching on the ignition, the SERVICE and engine diagnostic warning lamps come on and the UREA warning lamp flashes, accompanied by an audible signal and the display of a message (e.g.: "Emissions fault: Starting prevented in 150 miles") indicating the remaining range express in miles or kilometres. While driving, the message is displayed every 30 seconds while the fault with the SCR system persists.

You should go to a PEUGEOT dealer or a qualified workshop as soon as possible. If you fail to do this, there is a risk that you will not be able to start your engine.

Starting prevented



Every time the ignition is switched on, the SERVICE and engine diagnostic warning lamps come on and the UREA warning lamp flashes, accompanied by an audible signal and the display of the message "Emissions fault: Starting prevented".

! You have exceeded the authorised driving limit: the starting prevention system inhibits engine starting.

To be able to start the engine, you must call on a PEUGEOT dealer or a qualified workshop.

i Freezing of the AdBlue® additive

The AdBlue® additive freezes at temperatures below around -11°C. The SCR system includes a heater for the AdBlue® tank.

In exceptional circumstances (vehicle kept for a long period at temperatures that are constantly below -15°C), an emissions control system fault alert may be related to freezing of the AdBlue® in your vehicle.

Park your vehicle in a warmer area for a few hours until the additive becomes liquid again.

The emissions alert does not go off immediately, it will occur after several mile of running.

Topping-up the AdBlue® additive

Filling the AdBlue® tank is an operation included in every routine service on your vehicle by a PEUGEOT dealer or a qualified workshop.

Nevertheless, given the capacity of the tank, it may be necessary to top-up the additive between services, more particularly if an alert (warning lamps and a message) signals the requirement.

You can go to a PEUGEOT dealer or a qualified workshop.

If you envisage topping-up yourself, please read the following warnings carefully.

Precautions in use

The AdBlue® additive is an urea-based solution. This liquid is non-flammable, colourless and odourless (kept in a cool area).

In the event of contact with the skin, wash the affected area with soap and water. In the event of contact with the eyes, wash (irrigate) the eyes with large amounts of water or with an eye wash solution for at least 15 minutes. If a burning sensation or irritation persists, get medical attention.

If swallowed, immediately wash out the mouth with clean water and then drink plenty of water. In certain conditions (high ambient temperature, for example), the risk of release of ammonia cannot be excluded: do not inhale the product. Ammonia vapour has an irritant effect on mucous membranes (eyes, nose and throat).

Use only AdBlue® additive that meets the ISO 22241 standard.

! Never dilute the additive with water. Never pour the additive into the Diesel fuel tank.



AdBlue®

The supply in non-drip bottles simplifies topping-up. You can obtain 1.89 litre (half US gallon) bottles from a PEUGEOT dealer or a qualified workshop.

! Keep AdBlue® out of the reach of children, in its original bottle. Never transfer AdBlue® to another container: it would lose its purity.

! Never top-up from an AdBlue® dispenser reserved for heavy goods vehicles.

Recommendations on storage

AdBlue® freezes at about -11°C and deteriorates above 25°C. It is recommended that bottles be stored in a cool area and protected from direct sunlight.

Under these conditions, the additive can be kept for at least a year.

Additive that has been frozen can be used once it has thawed out.

! Never store bottles of AdBlue® in your vehicle.

Procedure

Before topping-up, ensure that the vehicle is parked on a flat and level surface. In wintry conditions, ensure that the temperature of the vehicle is above -11°C. Otherwise, by freezing, the AdBlue® cannot be poured into its tank. Park your vehicle in a warmer area for a few hours to allow the top-up to be carried out.

- ☞ Switch off the ignition and remove the key, or if your vehicle has one, press the START/STOP button to switch of the engine.

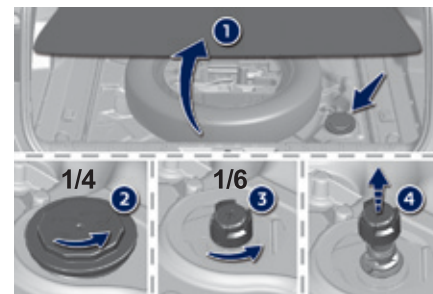

- ☞ For access to the AdBlue® tank, raise the boot carpet then lift out the spare wheel or storage box.
- ☞ Without pressing, turn the black cap a quarter turn anti-clockwise and lift it off.
- ☞ Turn the blue cap a 6th of a turn anti-clockwise.
- ☞ Lift off the cap.



- ☞ Obtain a bottle of AdBlue®. After first checking the use-by date, read carefully the instructions on use on the label before pouring the contents of the bottle into your vehicle's AdBlue® tank.

! Important: if your vehicle's AdBlue® tank is completely empty - which is confirmed by the alert messages and the impossibility of starting the engine - you must add at least 3.8 litres, so two 1.89 litre bottles.

- ☞ After emptying the bottle, wipe away any spillage around the tank filler using a damp cloth.

! If any additive is split or splashed, wash immediately with cold water or wipe with a damp cloth.
If the additive has crystallised, clean it off using a sponge and hot water.

- ☞ Refit the blue cap to the tank and turn it a 6th of a turn clockwise, to its stop.
- ☞ Refit the black cap and turn it a quarter of a turn clockwise without pressing. Ensure that the indicator on the cap lines up with the indicator on the support.
- ☞ Lower the boot floor and close the tailgate.

! Important: **when topping-up after running out of additive**, signalled by the message "Top up emissions additive: Starting prevented", you must wait for about 5 minutes before switching on the ignition, **without opening the driver's door, unlocking the vehicle, introducing the key into the ignition switch, or placing the key of the "Keyless Entry and Starting" system inside the vehicle.** Switch on the ignition, then wait for 10 seconds before starting the engine.



Never dispose of AdBlue® additive bottles in the household waste. Place them in a special container provided this purpose or take them to your dealer.

Version with DENON bass woofer unit

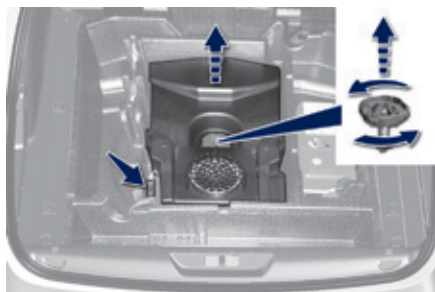

- Disconnect the connector: move the orange clip towards the rear, then while pressing the black part (located on top of the orange clip) pull the connector.
- Remove the yellow screw retaining the woofer unit.

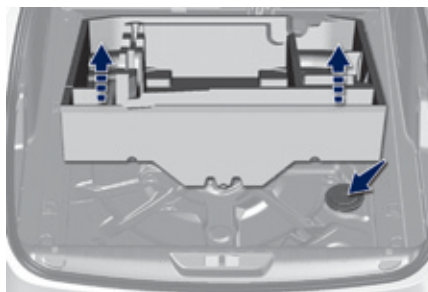

- Remove the woofer from the boot.
- Remove or raise the storage well.

For reassembly, first slacken the yellow screw a few turns.

Checking levels

Check all of these levels regularly, in line with the warranty and maintenance record. Top them up if necessary, unless otherwise indicated. If a level drops significantly, have the corresponding system checked by a PEUGEOT dealer or a qualified workshop.

! Take care when working under the bonnet, as certain areas of the engine may be extremely hot (risk of burns) and the cooling fan could start at any time (even with the ignition off).

Oil level



The check is carried out either when the ignition is switched on using the oil level indicator in the instrument panel, or using the dipstick.

It will only be correct if the vehicle is on level ground and the engine has been off for more than 30 minutes.

It is normal to top up the oil level between two services (or oil changes). PEUGEOT recommends that you check the level, and top up if necessary, every 3 000 miles (5 000 kms). After topping up the oil, the check when switching on the ignition with the oil level indicator in the instrument panel is not valid during the 30 minutes after topping up.

Engine oil change

Refer to the warranty and maintenance record for details of the interval for this operation. In order to maintain the reliability of the engine and emission control system, the use of additives in the engine oil is prohibited.

Oil specification

The oil must be the correct grade for your engine and conform to the manufacturer's recommendations.

Dipstick

There are two marks on the dipstick:



A = maximum
If the level is above this mark, contact a PEUGEOT dealer or a qualified workshop.

B = minimum
Top up the level through the oil filler orifice, using the correct grade of oil for your engine. The level must never be below this mark.

Brake fluid level

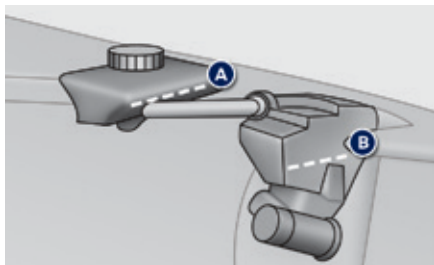

The brake fluid level must be between the marking "A" (MAX located on the remote reservoir) and the marking "B" (MIN located on the main reservoir). If it is not, check the brake pad wear.

Changing the fluid

Refer to the warranty and maintenance record for details of the interval for this operation.

Fluid specification

The brake fluid must conform to the manufacturer's recommendations.

Coolant level



The coolant level should be close to the "MAX" mark but should never exceed it.

When the engine is warm, the temperature of the coolant is regulated by the fan.

The cooling fan may start after switching off the engine: take care with articles and clothing that might become caught by the fan blades.

In addition, as the cooling system is pressurised, wait at least one hour after switching off the engine before carrying out any work.

To avoid any risk of scalding, unscrew the cap by two turns to allow the pressure to drop. When the pressure has dropped, remove the cap and top up the level.

Changing the coolant

The coolant does not have to be replaced at routine services.

Fluid specification

The coolant must conform to the manufacturer's recommendations.

Screenwash and headlamp wash fluid



In the case of vehicles fitted with headlamp washers, the low fluid level is indicated by an audible signal and a message in the instrument panel screen.

Top up the reservoir when you next stop the vehicle.

Fluid specification

For optimum cleaning and to avoid freezing, this fluid must not be topped up with or replaced with plain water.

In wintry conditions, the use of an ethyl alcohol or methanol base fluid is recommended.

Diesel additive level (Diesel engine with particle emission filter)

SERVICE

A low additive level is indicated by illumination of the service warning lamp, accompanied by an audible warning and a message in the instrument panel screen.

Topping up

This additive must be topped up by a PEUGEOT dealer or a qualified workshop without delay.

Used products



Avoid prolonged contact of used oil or fluids with the skin. Most of these fluids are harmful to health or indeed very corrosive.



Do not discard used oil or fluids into sewers or onto the ground. Take used oil to a PEUGEOT dealer or a qualified workshop (France) or to an authorised waste disposal site.

Checks

Unless otherwise indicated, check these components in accordance with the warranty and maintenance record and according to your engine. Otherwise, have them checked by a PEUGEOT dealer or a qualified workshop.

12 V battery



The battery does not require any maintenance. However, check that the terminals are clean and correctly tightened, particularly in summer and winter.

When carrying out work on the battery, refer to the "12 V battery" section for details of the precautions to be taken before disconnecting the battery and following its reconnection.

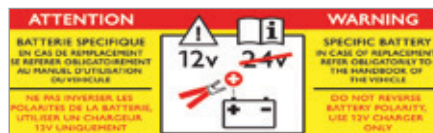

The presence of this label, in particular with the Stop & Start system, indicates the use of a specific 12 V lead-acid battery with special technology and specification. The involvement of a PEUGEOT dealer or a qualified workshop is essential when replacing or disconnecting the battery.

Air filter and passenger compartment filter



Refer to the warranty and maintenance record for details of the replacement intervals for these components.

Depending on the environment (e.g. dusty atmosphere) and the use of the vehicle (e.g. city driving), **replace them twice as often if necessary.**

A clogged passenger compartment filter may have an adverse effect on the performance of the air conditioning system and generate undesirable odours.

Oil filter



Replace the oil filter each time the engine oil is changed.

Refer to the warranty and maintenance record for details of the replacement interval for this component.

Particle emission filter (Diesel)

SERVICE

The start of saturation of the particle filter is indicated by the temporary illumination of this warning lamp accompanied by a message in the multi-function screen.

i As soon as the traffic conditions permit, regenerate the filter by driving at a speed of at least 40 mph (60 km/h) until the warning lamp goes off. If the warning lamp stays on, this indicates a low additive level.

On a new vehicle, the first particle filter regeneration operations may be accompanied by a "burning" smell, which is perfectly normal. Following prolonged operation of the vehicle at very low speed or at idle, you may, in exceptional circumstances, notice the emission of water vapour at the exhaust on acceleration. This does not affect the behaviour of the vehicle or the environment.

Manual gearbox



The gearbox does not require any maintenance (no oil change). Refer to the warranty and maintenance record for the details of the level checking interval for this component.

Automatic gearbox



The gearbox does not require any maintenance (no oil change). Refer to the warranty and maintenance record for details of the level checking interval for this component.

Parking brake



If excessive travel or a loss of effectiveness of this system is noticed, the parking brake must be checked, even between two services.

Checking this system must be done by a PEUGEOT dealer or a qualified workshop.

Brake pads



Brake wear depends on the style of driving, particularly in the case of vehicles used in town, over short distances. It may be necessary to have the condition of the brakes checked, even between vehicle services. Unless there is a leak in the circuit, a drop in the brake fluid level indicates that the brake pads are worn.

Brake disc wear



For information on checking brake disc wear, contact a PEUGEOT dealer or a qualified workshop.

Electric parking brake



This system does not require any routine servicing. However, in the event of a problem, have the system checked by a PEUGEOT dealer or a qualified workshop.

For more information, refer to the "Electric parking brake - Operating faults" section.

! Only use products recommended by PEUGEOT or products of equivalent quality and specification. In order to optimise the operation of units as important as those in the braking system, PEUGEOT selects and offers very specific products. After washing the vehicle, dampness, or in wintry conditions, ice can form on the brake discs and pads: braking efficiency may be reduced. Make light brake applications to dry and defrost the brakes.

Engines

The values (engine capacity, net maximum power, power to weight ratio, engine speed, CO₂ emissions, ...) are given in your vehicle's registration document.

They can also be obtained from PEUGEOT dealers and are included in the descriptive table of technical characteristics for the vehicle in sales brochures.

i For more information, contact a PEUGEOT dealer or a qualified workshop.

Weights and towed loads

The weights are given in the registration certificate for your vehicle and on the manufacturer's VIN plate.

The information can also be obtained from PEUGEOT dealers and is included in the descriptive table of technical characteristics for the vehicle in sales brochures.

The maximum type-approved trailer weight varies according to market zone.

In each country, you must comply with local legislation on towed loads.

i For information on your vehicle's towing capabilities and its gross train weight, contact a PEUGEOT dealer.

Load transfer

If the towing vehicle has not reached the GVW, it is possible to transfer this weight to the trailer.

The gross train weight and maximum trailer weight are valid up to an altitude of 1 000 metres; the maximum trailer weight specified must be reduced by 10 % for every additional 1 000 metres of altitude.

In all cases, do not exceed the weight of the trailer and the GTW, indicated on your registration certificate.

Observe the towing capacities of your vehicle.

The weight of a braked trailer with load transfer can be increased on condition that the equivalent weight is removed from the vehicle and the GTW is not exceeded.

High ambient temperatures may result in a reduction in the performance of the vehicle to protect the engine. If the ambient temperature is above 37 °C, limit the towed load to 700 kg, without any transfer of load.

The speed of a towing vehicle must not exceed 60 mph (100 km/h) (comply with the legislation in force in your country).

The recommended nose weight (weight on the towbar ball) is **75 kg**.

Dimensions (in mm)

These dimensions have been measured on a vehicle that is not loaded.

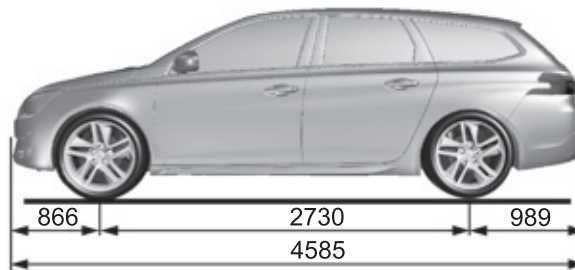
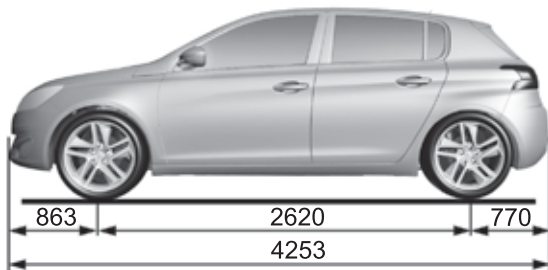
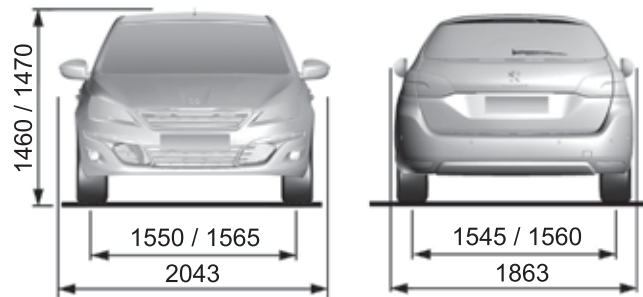
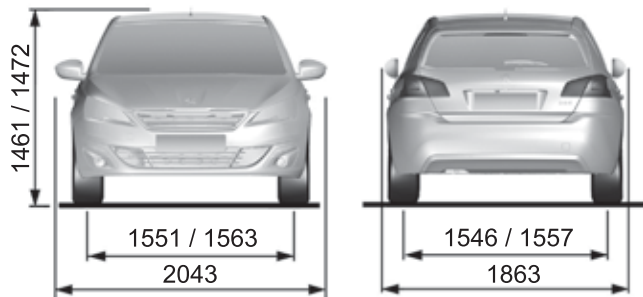

Identification markings

Various visible markings for the identification of your vehicle.



A. Vehicle Identification Number (VIN) under the bonnet.

This number is engraved on the chassis near the right hand front wheel arch.

B. Vehicle Identification Number (VIN) on the windscreen lower cross member.

This number is indicated on a self-adhesive label which is visible through the windscreen.

C. Manufacturer's label.

This self-destroying label affixed to the centre pillar, right or left hand side, contains the following information.

- the manufacturer's name,
- the European whole vehicle type approval number,
- the vehicle identification number (VIN),
- the maximum authorised weight (gross vehicle weight),
- the maximum authorised weight with trailer (gross train weight),
- the maximum front axle weight,
- the maximum rear axle weight.

D. Tyre/paint label.

This label, affixed to the centre pillar, on the driver's side, contains the following information.

- the tyre inflation pressures with and without load,
- the tyre sizes (including the tyre load index and speed rating),
- the inflation pressure for the spare wheel,
- the paint colour code.

i The tyre pressures must be checked when the tyres are cold, at least once a month.

🍀 If the tyre pressures are too low, this increases fuel consumption.



EMERGENCY OR ASSISTANCE CALL

EMERGENCY OR ASSISTANCE CALL

PEUGEOT Connect SOS



In an emergency, press this button for more than 2 seconds. Flashing of the green LED and a voice message confirm that the call has been made to the "PEUGEOT Connect SOS" centre*.

The green LED remains on (without flashing) when communication is established. It goes off at the end of communication.

Pressing this button again immediately cancels the request. The green LED goes off. Cancellation is confirmed by a voice message.

To cancel a call, tell the "PEUGEOT Connect SOS" call centre that the call was a mistake.

"PEUGEOT Connect SOS" immediately locates your vehicle, starts communication with you in your language**, and where necessary sends the appropriate public emergency services**. In countries where the service is not available, or when the locating service has been expressly declined, the call sent directly to the emergency services (112) without the vehicle location.



If an impact is detected by the airbag control unit, and independently of the deployment of any airbags, an emergency call is made automatically.

* Subject to the general conditions for the service available from dealers and to technological and technical limitations.

** Depending on the geographical cover of "PEUGEOT Connect SOS", "PEUGEOT Connect Assistance" and the official national language selected by the owner of the vehicle.

The list of countries covered and PEUGEOT CONNECT services is available from dealers or at www.peugeot.co.uk.

PEUGEOT Connect Assistance



Press this button for more than 2 seconds to request assistance if the vehicle breaks down. A voice message confirms that the call has been made**.

Pressing this button again immediately cancels the request. The cancellation is confirmed by a voice message.

Operation of the system



When the ignition is switched on, the green LED comes on for 3 seconds indicating that the system is operating correctly.



If the orange LED flashes: there is a system fault.

If the orange LED is on continuously: the backup battery must be replaced.

In either case, contact a PEUGEOT dealer.

If you purchased your vehicle outside the PEUGEOT dealer network, we invite you to have a dealer check the configuration of these services and, if desired, modified to suit your wishes. In a multi-lingual country, configuration is possible in the official national language of your choice.

For technical reasons and in particular to improve the quality of "PEUGEOT CONNECT services" services to customers, the manufacturer reserves the right to carry out updates to the vehicle's on-board telematic system.

DENON EQUIPMENT

The new DENON Hi-Fi system in the PEUGEOT 308 is a tailored technological solution comprising 9 speakers and a digital amplifier.

The DENON technology offers efficient components providing high performance:

- 4 flexible membrane tweeters with resonance chamber to minimise audio distortion. 100% active at the front of the vehicle.
- 4 CosCone™ woofers: a technology allowing a high level of sensitivity and speaker cone travel, generating high bass performance despite a very flat form.
- 1 sub-woofer with a 100W speaker installed under the boot floor, without affecting the load volume of the boot.
- 1 Class-D 8-way digital amplifier. Improved control of running noises. 2 audio distribution settings available to suit the number of occupants in the vehicle (driver or passengers).
- "Digital Coloration" technology giving the engine a more sporty and refined sound.



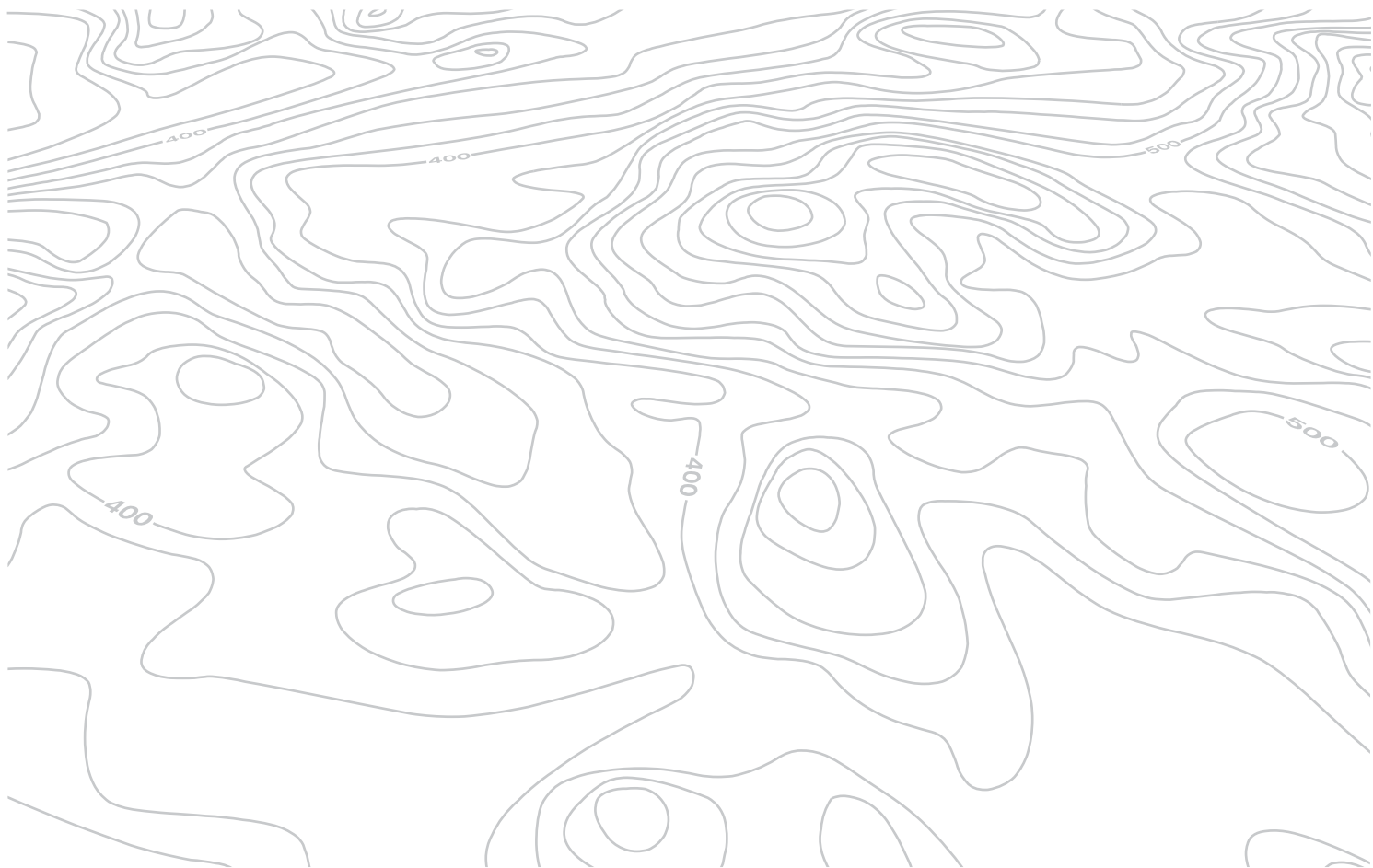

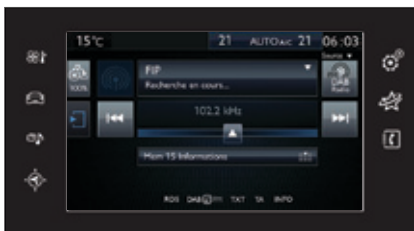

Touch screen

SATELLITE NAVIGATION SYSTEM

MULTIMEDIA AUDIO SYSTEM

BLUETOOTH TELEPHONE



The system is protected in such a way that it will only operate in your vehicle.



For safety reasons, the driver must carry out operations which require prolonged attention while the vehicle is stationary.

When the engine is switched off and to prevent discharging of the battery, the system switches off following the activation of the energy economy mode.

CONTENTS

01	General operation	p. 294
02	First steps - Control panel	p. 296
03	Steering mounted controls	p. 297
04	Media	p. 298
05	Navigation	p. 316
06	Configuration	p. 336
07	Connected services	p. 346
08	Telephone	p. 348
	Frequently asked questions	p. 358

01 GENERAL OPERATION



"Air conditioning"
allows control of the settings for temperature and air flow.



"Driving assistance"
allows access to the trip computer and certain vehicle functions to be activated, deactivated and settings adjusted.

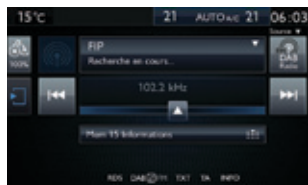

"Media"
allows selection of a radio station, the various music sources and the display of photographs.



"Navigation"
allows settings for navigation and the choice of a destination (depending on version).

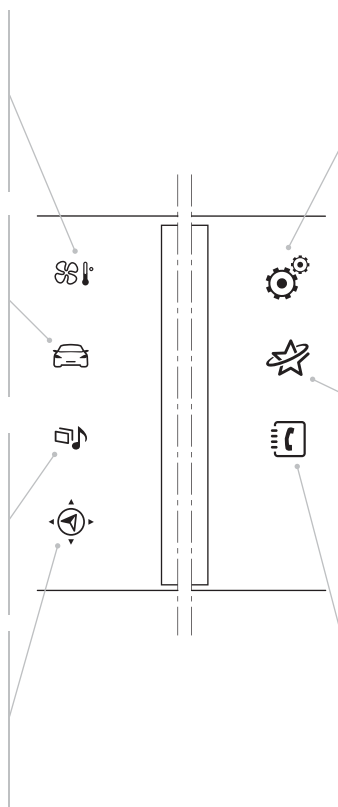

"Configuration"
allows sound settings, the color scheme and the brightness of instruments and controls to be adjusted and gives access to the interactive help for the main vehicle systems and warning lamps.

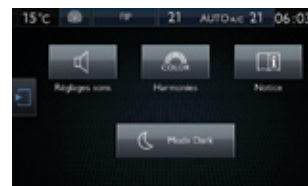

"Connected services"
allows connection to an applications portal to facilitate, make safe and personalise journeys by means of a connection key available on subscription from a PEUGEOT dealer.



"Telephone"
allows the connection of a mobile telephone via Bluetooth.

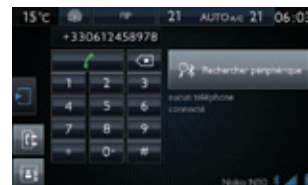

01 GENERAL OPERATION

Use the buttons on either side of the touch screen for access to the menus, then press the virtual buttons in the touch screen.

Each menu is displayed in one or two pages (primary page and secondary page).

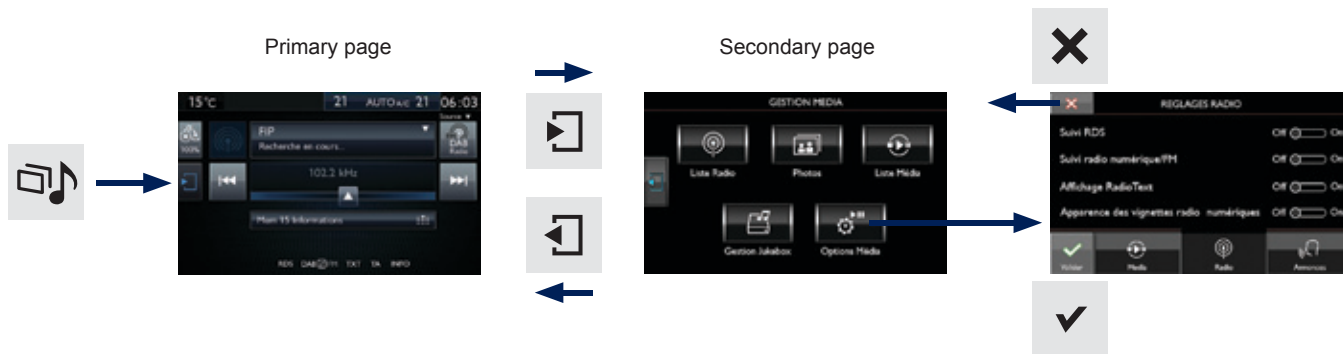

In very hot conditions, the system may go into stand-by (screen and sound completely off) for a minimum period of 5 minutes.

02 FIRST STEPS

Shortcuts: using virtual buttons in the top band of the touch screen, it is possible to go directly to the choice of audio source, the list of stations (or titles depending on the source) or to temperature adjustment.



Volume adjustment (each source is independent, including Traffic announcements (TA) and navigation instructions).

i Following prolonged operation in sunny conditions, the volume may be limited to protect the system. The return to normal takes place when the temperature in the passenger compartment drops.



With the engine running, press to mute the sound.

With the ignition off, press to switch the system on.

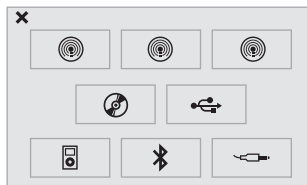

Selecting the audio source (depending on version):

- "FM" / "AM" / "DAB"* radio wavebands.
- "USB" memory stick.
- CD player (located in the glove box)*.
- Jukebox*, after first copying audio files to the internal memory of the touch screen tablet.
- Telephone connected by Bluetooth and Bluetooth audio streaming.
- Media player connected to the auxiliary socket (jack, cable not supplied).

i The screen is of the "resistive" type, it is necessary to press firmly, particularly for "flick" gestures (scrolling through a list, moving the map...). A simple wipe will not be enough. pressing with more than one finger is not recognised. The screen can be used when wearing gloves. This technology allows use at all temperatures.

! To clean the screen, use a soft non-abrasive cloth (spectacles cloth) without any additional product. Do not use pointed objects on the screen. Do not touch the screen with wet hands.

* Depending on equipment.

03 STEERING MOUNTED CONTROLS



		- Press: mute / restore sound.
		- Increase volume.
		- Decrease volume.
		- Press: change the audio source: Radio, Media.

		<ul style="list-style-type: none"> - Rotation. Radio: automatic selection of next / previous frequency. Media: previous / next track. Menus: movement
		<ul style="list-style-type: none"> - Press. Radio: pre-set radio stations. Menus: confirm. Audio source: confirm selection
		<ul style="list-style-type: none"> - Incoming call: answer call. - Call in progress: Telephone menu (contacts, call log). End call.
		<ul style="list-style-type: none"> - Radio: display the list of stations. Media: display the list of albums / tracks.

04 MEDIA



Level 1

Level 2

Level 3



















 **"Media"**
Primary page

List of FM stations

Autorout









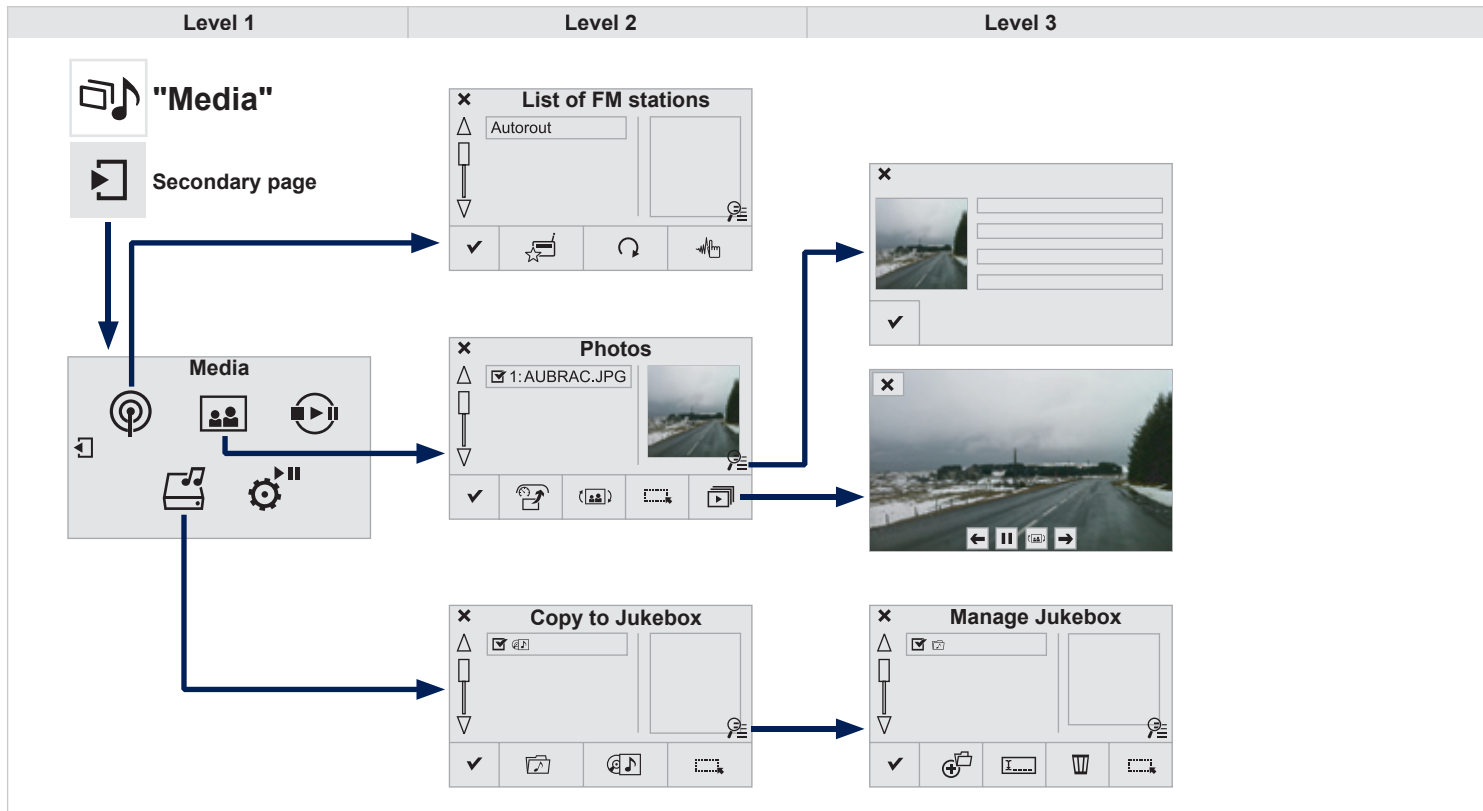





















Recalling preset stations

Ⓜ	Ⓜ	Ⓜ
Ⓜ	Ⓜ	Ⓜ
Ⓜ	Ⓜ	Ⓜ
Ⓜ	Ⓜ	Ⓜ
Ⓜ	Ⓜ	Ⓜ

Level 1		Level 2		Level 3	Comments
	Media ↓		List of FM stations		Press on a radio station to select it.
	List →		Confirm		Save the settings.
	Media ↓	 <small>Radio FM</small>	FM Radio		Select change of source.
	Source →	 <small>Radio DAB</small>	DAB Radio		
		 <small>Radio AM</small>	AM Radio		
			Jukebox		
			CD		
			USB		
			iPod		
			Bluetooth		
			AUX		
			Video		
	Media ↓		Recall of preset stations		Press on a radio station to select it.
	Memo →				

04 MEDIA



Level 1		Level 2		Level 3		Comments			
  	Media ↓ Secondary page ↓ Radio list →	 Preset				Press a radio station to select it.			
		 Update list				Update the list of stations received.			
		 Frequency				Enter the desired radio frequency.			
		 Confirm				Save the settings.			
  	Media ↓ Secondary page ↓ Photos →	 Page selection				Display the selected photo full screen.			
		 Rotate				Rotate the photo 90°.			
		 Select all				Select all the photos in the list. Press again to deselect.			
		 Slideshow	 Previous photo.	 Pause / Play.	 Next photo.		Display the photos in sequence, full screen.		
		 Confirm					Save the settings.		
		 Sort by folder					Choose the selection mode.		
		 Sort by album							
  	Media ↓ Secondary page ↓ Manage Jukebox →	 Select all				Choose the handling mode.			
		 Magnifying glass	 Create folder	 Rename	 Delete				
			 Select all	 Confirm				Save the options.	
			 Copy						Save the settings.

04 MEDIA



Level 1

Level 2

Level 3









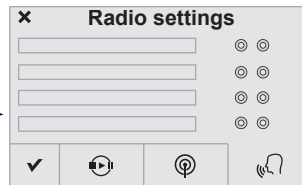
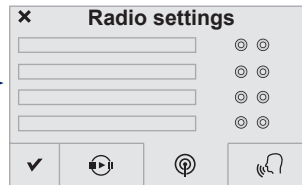
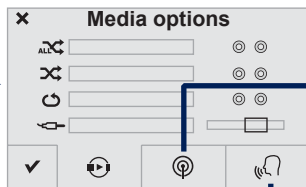







"Media"



Secondary page



Level 1		Level 2		Level 3		Comments
  	<p>Media</p> <p>↓</p> <p>Secondary page</p> <p>↓</p> <p>Media list</p> <p>→</p>					Presentation of the last media used.
  	<p>Media</p> <p>↓</p> <p>Secondary page</p> <p>↓</p> <p>Media options</p> <p>→</p>		<p>Media</p> <p>↓</p> <p>Media options</p> <p>→</p>	 Random (all tracks):	Choose the play settings.	
				 Random (current album):		
				 Loop:		
				 Aux. amplification		
			<p>Radio</p> <p>↓</p> <p>Radio settings</p> <p>→</p>	<input type="checkbox"/> RDS options	Activate or deactivate the options.	
				<input type="checkbox"/> DAB/FM options		
				<input type="checkbox"/> Display Radio Text		
				<input type="checkbox"/> DAB radio thumbnails		
			<p>Announcements</p> <p>↓</p> <p>Radio settings</p> <p>→</p>	<input type="checkbox"/> Traffic announcements (TA)	Activate or deactivate the options.	
				<input type="checkbox"/> Weather		
				<input type="checkbox"/> Varied - Sport		
				<input type="checkbox"/> Alert settings		
	Confirm				Save the settings.	

04 RADIO

Selecting a station

1a Press on **Media** to display the primary page.
or
Press on **Media** to display the primary page
then go to the secondary page.



2a Select "**List**" in the primary page.
or
Select "**Radio list**" in the secondary page.



3a Select a radio station from the list offered.

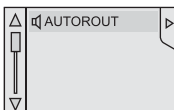

 Select "**Update list**" to refresh the list.



1b Press **Media** to display the primary
page then select "**Memo**".



OR

2b Select a preset radio station in the list.

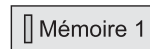

1 If necessary, select change of source.



2 Select "**FM Radio**" or "**AM Radio**".



 The exterior environment (hills, buildings, tunnel, car park, below ground...) may prevent reception, even in RDS station tracking mode. This phenomenon is normal in the propagation of radio waves and is in no way indicative of a fault with the audio system.

04 RADIO

Changing a radio frequency

1a

Press on **Media** to display the primary page.



2a

By automatic frequency search

Press ◀ or ▶ to move the cursor for an automatic search down or up for a radio frequency.

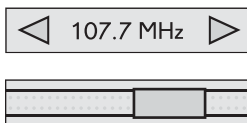

OR

1b

Press on **Media** to display the primary page then press on the secondary page.



2b

Press on "**Enter frequency**" to display the primary page then press on the secondary page.



THEN

3a

Select change source.



3b

Select "**FM Radio**" or "**AM Radio**".



OR

3c

Enter the frequency in full (e.g.: 92.10 MHz) using the keypad then "**Confirm**".



3d

By alphabetical list

Press the current radio band then choose the radio station from the list offered.



04 RADIO

Preset a station

1 Select a radio station or frequency
(refer to the corresponding section).

2 Press on "**Preset**".



3 Select a number in the list to preset the
previously chosen radio station.
A long press on a number presets (memorises)
the station.
Or
A press on this button presets all of the stations
one after the other.

Mémoire 1



Recall pre-set stations

Press on **Media** to display the primary page
then select "**Memo**".



04 RADIO

Activate/ Deactivate RDS

1

Press on **Media** to display the primary page then go to the secondary page.



2

Select "**Settings**".



3

Select "**Radio**".



4

Activate/deactivate "**RDS options**".

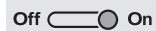

i

RDS, if activated, allows you to continue listening to the same station by automatic retuning to alternative frequencies. However, in certain conditions, coverage of an RDS station may not be assured throughout the entire country as radio stations do not cover 100 % of the territory. This explains the loss of reception of the station during a journey.

04 RADIO

Display of the name of the current station.

Short-cut: access to some of the settings for the air conditioning, radio and changing the audio source.

Select the radio station.

Any thumbnail broadcast by the station.

Manage the Jukebox.
Display current action.

Secondary page.

Previous "Multiplex".
Previous radio station.

Display the name and number of the multiplex service being used.



Select the audio source.
Display the "DAB" band.

Display of "Radiotext" for the current station.

Next "Multiplex".
Next radio station.

Preset stations, buttons 1 to 15.
Short press: select the preset radio station.
Long press: preset a radio station.

Display of options:
if active but not available, the display will be greyed out,
if active and available, the display will be blank.



If the "DAB" radio station being listened to is not available on "FM", the "DAB FM" option is greyed out.

04 RADIO

DAB (Digital Audio Broadcasting) Digital radio

! Digital radio provides higher quality reception and also the graphical display of current information on the radio station being listened to. Select "List" in the primary page.
The range of multiplexes available is displayed in alphabetical order.

1 Press on **Media** to display the primary page.



2 Select change of source.



3 Select "**DAB Radio**".



4 Select "**List**" in the primary page.
or
Select "**Radio list**" in the secondary page.



5 Select the radio station from the list offered.

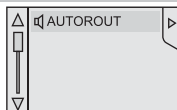

Digital radio - DAB / FM auto tracking

i "DAB" does not cover 100% of the territory.
When the digital radio signal is weak, "DAB / FM auto tracking" allows you to continue listening to the same station, by automatically switching to the corresponding "FM" analogue station (if there is one).

1 Press **Media** to display the primary page then press on the secondary page.



2 Select "**Settings**".



3 Select "**RADIO**".



4 Select "**Digital/FM auto tracking**" then "**Confirm**".



i If "DAB / FM auto tracking" is activated, there is a difference of a few seconds when the system switches to "FM" analogue radio with sometimes a variation in volume.
When the digital signal is restored, the system automatically changes back to "DAB".

! If the "DAB" station being listened to is not available on "FM" ("**DAB/FM**" option greyed out), or "DAB / FM auto tracking" is not activated, the sound will cut out while the digital signal is too weak.

04 MUSIC

CD, MP3 CD, USB player, auxiliary input



Insert the CD in the player, insert the USB memory stick in the USB player or connect the USB peripheral to the USB port using a suitable cable (not supplied).

The system builds playlists (in temporary memory), an operation which can take from a few seconds to several minutes at the first connection.

Reduce the number of non-music files and the number of folders to reduce the waiting time.

The playlists are updated every time the ignition is switched off or connection of a USB memory stick. However, the system memorises these lists and if they are not modified, the loading time will be shorter.



Selection of source

- 1 Press on **Media** to display the primary page.
- 2 Select change of source then choose the source.

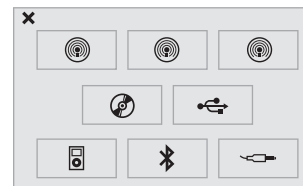

The steering mounted **SRC** (source) button can be used to go to the next media source, available if the source is active. Press **OK** to confirm the selection.

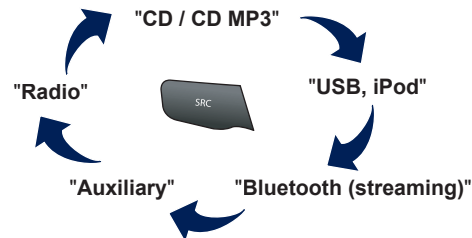

04 MUSIC

CD, MP3 CD / USB player

Information and advice



The audio equipment will only play audio files with ".wma, .aac, .flac, .ogg and .mp3" file extensions and with a bit rate of between 32 Kbps and 320 Kbps.

It also supports VBR (Variable Bit Rate) mode.

No other type of file (.mp4, ...) can be played.

WMA files must be of the standard wma 9 type.

The sampling rates supported are 11, 22, 44 and 48 KHz.



It is advisable to restrict file names to 20 characters, without using of special characters (e.g.: " " ? ; ù) to avoid any playing and displaying problems.



In order to be able to play a recorded CDR or CDRW, when recording it is preferable to select the ISO 9660 level 1, 2 or Joliet standard.

If the disc is recorded in another format it may not be played correctly.

It is recommended that the same recording standard is always used for an individual disc, with as low a speed as possible (4x maximum) for optimum sound quality.

In the particular case of a multi-session CD, the Joliet standard is recommended.



The system supports USB mass storage devices, BlackBerry® devices or Apple® players via the USB port located in the glove box (if your vehicle has one). The adaptor cable not supplied. Control of the peripheral device is with the audio system controls. Other peripherals, not recognised on connection, must be connected to the auxiliary socket using a Jack cable (not supplied).



In order to be read, a USB memory stick must be formatted FAT 16 or 32.







The system does not support two identical devices connected at the same time (two memory sticks, two Apple® players) but it is possible to connect one memory stick and one Apple® player at the same time.







It is recommended that official Apple® USB cables are used to ensure correct operation.

04 MUSIC

Selecting a track to play

Previous track.	
Next track.	
Previous folder.	
Next folder.	
Pause.	

List of USB or CD tracks and folders.	
Up or down in the list.	
Confirm, next menu level.	
Up one menu level.	

04 MUSIC

Connecting APPLE® players

1

Connect the Apple® player to one of the USB ports using a suitable cable (not supplied). Play starts automatically.



2

Control is via the audio system.

i

The classifications available are those of the portable device connected (artists / albums / genres / playlists / audiobooks / podcasts).
The default classification used is by artist. To modify the classification used, return to the first level of the menu then select the desired classification (playlists for example) and confirm to go down through the menu to the desired track.

i

Copies of photos and album artwork are not compatible with the audio system. These appear only with a USB memory stick.

!

The version of software in the audio system may not be compatible with the generation of your Apple® player.

Audio streaming

☀

Streaming allows audio files on your telephone to be played via the vehicle's speakers.

1

Connect the telephone: see the "**Telephone**" section, then "**Bluetooth**".
Choose the "**Audio**" or "**All**" profile.

2

If play does not start automatically, it may be necessary to start the audio playback from the telephone.
Control is from the peripheral device or by using the audio system buttons.

!

Once connected in streaming mode, the telephone is considered to be a media source.
It is recommended that you activate "**Repeat**" on the Bluetooth peripheral.

04 MUSIC

Using the auxiliary input (AUX) (cable not supplied)

- 1 Connect the portable device (MP3 player...) to the auxiliary JACK socket using an audio cable.



- 2 Select **Media** to display the primary page.



- 3 Select change the source.



- 4 Select the **AUXILIARY** source.



- i** First adjust the volume of your portable device (to a high level). Then adjust the volume of your audio system. Display and management of the controls are via the portable device.

04 MUSIC

Managing the Jukebox

1

Connect the device (MP3 player...) to the USB port or auxiliary socket using a suitable audio cable.

i

When no audio file is copied to the system with a capacity of 8GB, all of the Jukebox function symbols are greyed and are not available.

2

Select "**Media list**".



3

Select copy "**Copy Jukebox**".



4

Select "**Sort by folder**" or "**Sort by album**".



5

Select the magnifying glass to enter the folder or album and select audio file by audio file.



6

Select "**Confirm**" then "**Copy**".



7

Select "**New folder**" to create a folder structure in the Jukebox or select "**Keep structure**" to retain the structure from the device.











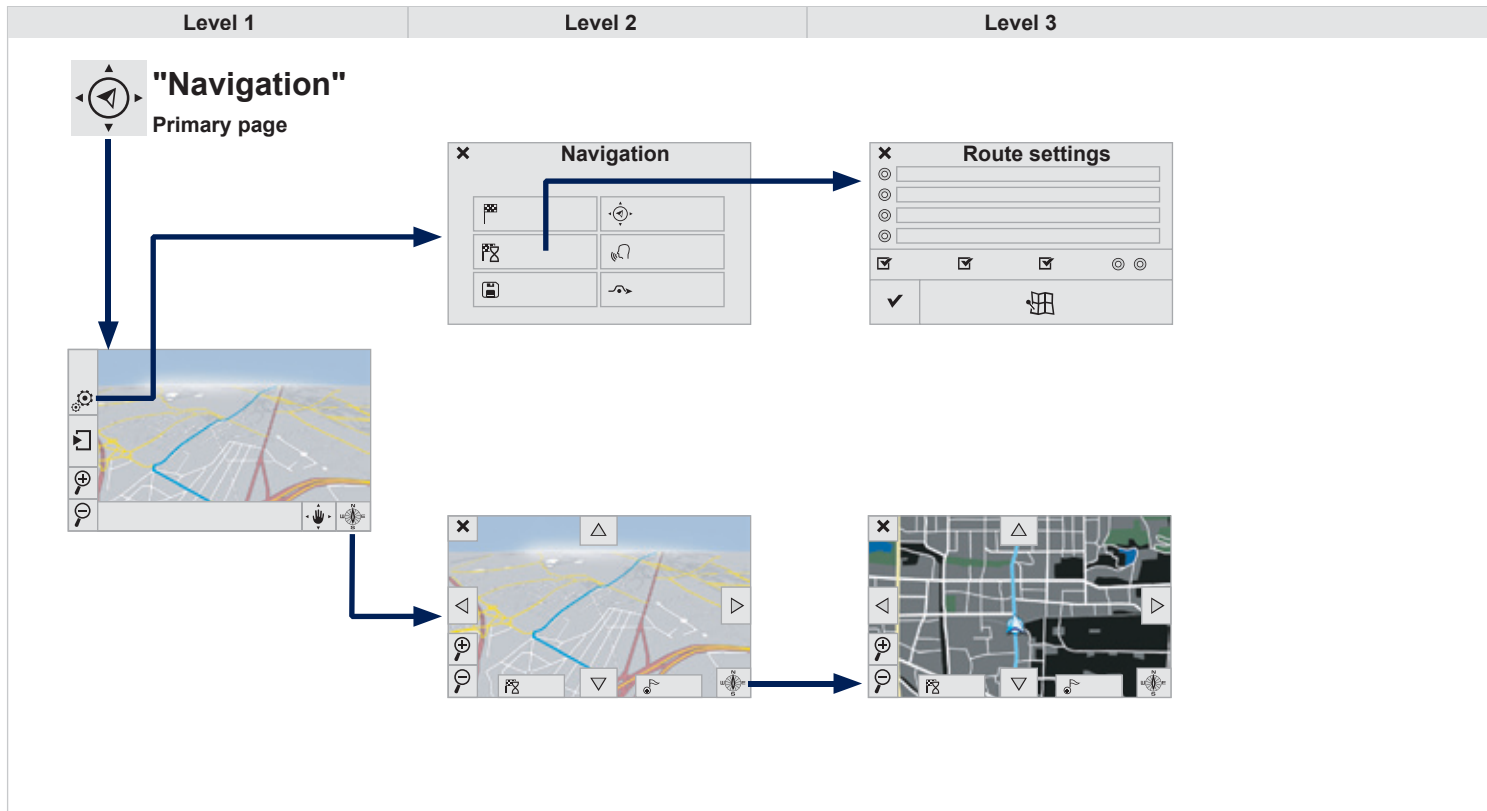







8

While copying the system returns to the primary page; you can go back to the copy view at any time by selecting this button.











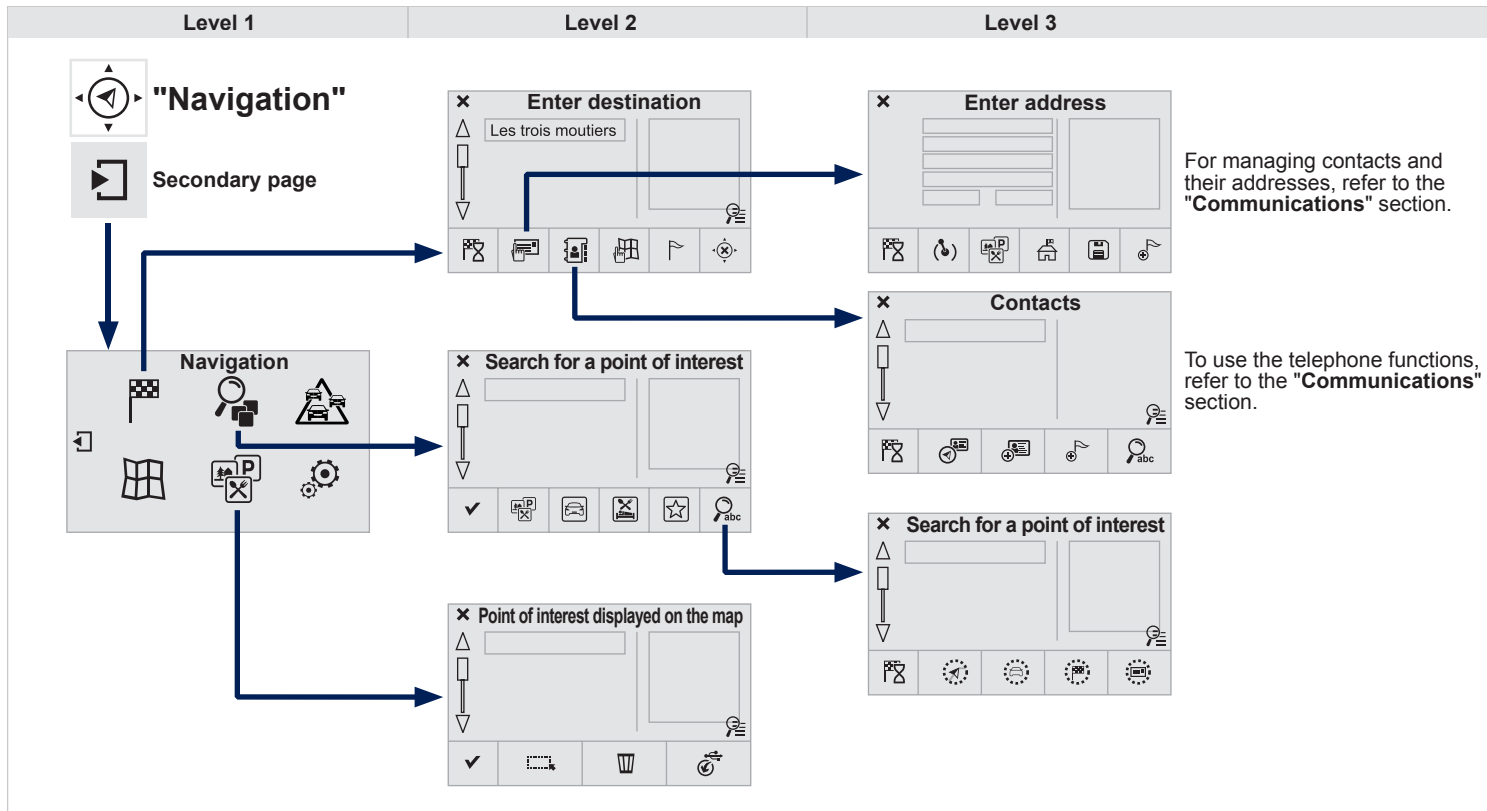



























05 NAVIGATION



Level 1		Level 2		Level 3		Comments
  Navigation ↓ Settings Navigation →	 Recent destinations	 Calculatory criteria	<input type="radio"/>	Fastest	Choose the navigation criteria. The map displays the route chosen according to these criteria.	
			<input type="radio"/>	Shortest		
			<input type="radio"/>	Time/distance		
			<input type="radio"/>	Ecological		
			<input checked="" type="checkbox"/>	Tolls		
			<input checked="" type="checkbox"/>	Ferries		
			<input type="checkbox"/>	Strict - Close		
			<input type="checkbox"/>	Show route on map	Display the map and start navigation.	
			<input checked="" type="checkbox"/>	Confirm	Save the options.	
			 Save current location		Save the current address.	
 Stop navigation		Delete the navigation information.				
 Voice synthesis		Choose the volume for voice and announcement of street names.				
 Diversion		Detour from your initial route by a certain distance.				
  Navigation ↓ Map →			Zoom in.			
			Zoom out.			
			Use the arrows to move the map.			
			Calculatory criteria			
			Add a waypoint.			
			Switch to 2D map.			









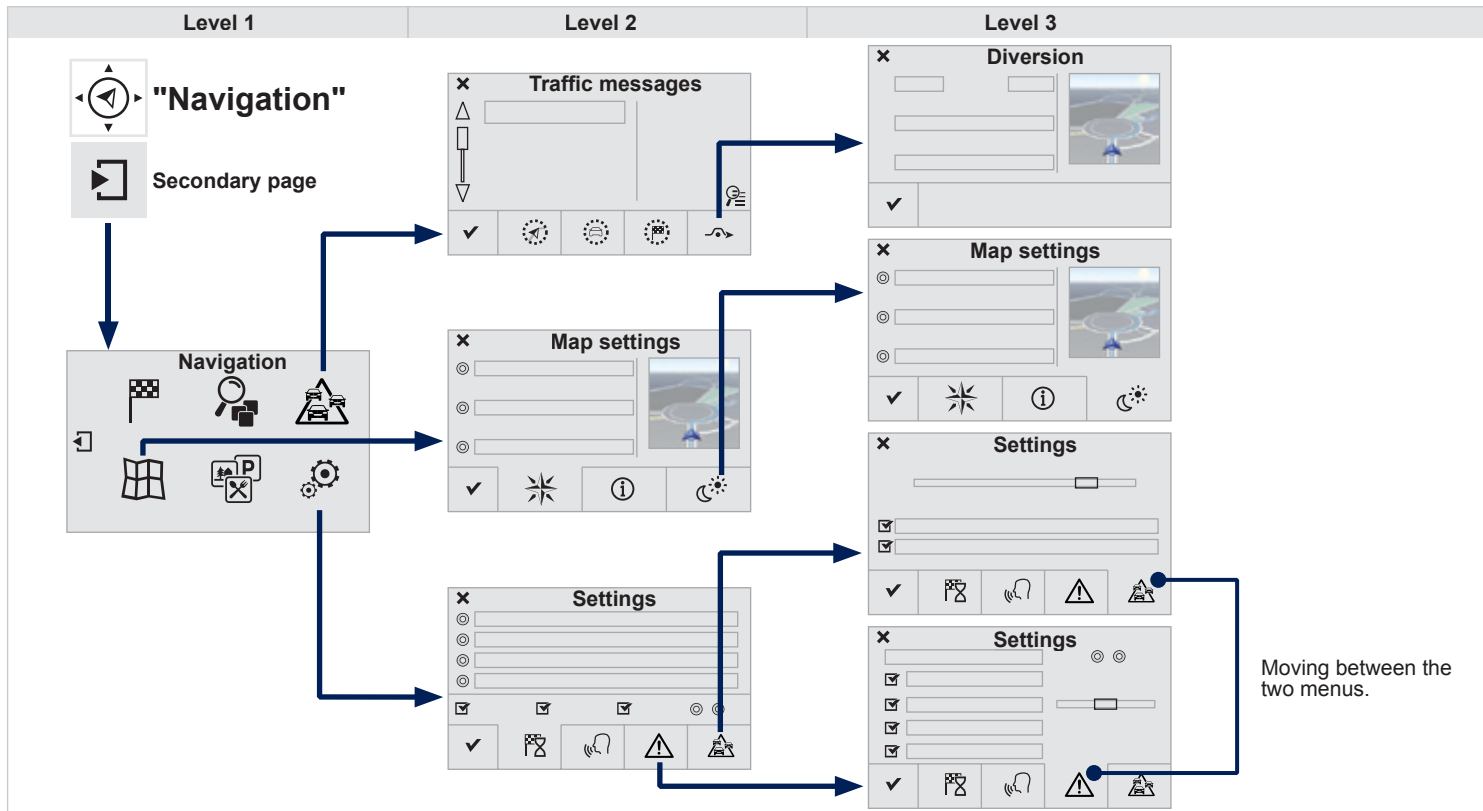











05 NAVIGATION



Level 1		Level 2		Level 3		Comments	
  	<p>Navigation</p> <p>↓</p> <p>Secondary page</p> <p>↓</p> <p>Enter destination</p> <p>→</p>		<p>Enter address</p>		Curr. location	Address settings.	
					Points of Interest		
					Town centre		
					Save		Save the current address.
					Add waypoint		Add a waypoint to the route.
			<p>Contacts</p>		Navigate to	Press to calculate the route.	
					Addresses	Select a contact then calculate the route.	
					Add contact		
					Add waypoint		
					Search for contact		
	Navigate to						
	From map		Display the map and zoom to view the roads.				
	Add waypoint		Create, add or delete a waypoint or view the itinerary.				
	Stop navigation		Delete navigation information.				
	Navigate to		Press to calculate the route.				
  	<p>Navigation</p> <p>↓</p> <p>Secondary page</p> <p>↓</p> <p>Search for a point of interest</p> <p>→</p>		All POIs	List of categories available. After choosing the category, select the points of interest.			
			Garage				
			Dining/hotels				
			Personal				
			By name				
	Confirm		Save the settings.				
  	<p>Navigation</p> <p>↓</p> <p>Secondary page</p> <p>↓</p> <p>Display point of interest</p> <p>→</p>		Select all	Choose the display settings for POIs.			
			Delete				
			Import POIs				
			Confirm		Save the options.		

05 NAVIGATION



Level 1		Level 2		Level 3		Comments	
  	Navigation ↓ Secondary page ↓ Traffic messages →	 On the route				Settings for the choice of messages and the filter radius.	
		 Around					
		 Near destination					
		 Detour	<input type="radio"/> Detour over a distance				
		<input checked="" type="checkbox"/> Finish	<input type="radio"/> Recalculate route				
  	Navigation ↓ Secondary page ↓ Map settings →	 Orientation	<input type="radio"/> Flat view north heading			Choose the display and orientation of the map.	
			<input type="radio"/> Flat view vehicle heading				
				<input type="radio"/> Perspective view			
		 News					
		 Aspect	<input type="radio"/> "Day" map colour				
			<input type="radio"/> "Night" map colour				
			<input type="radio"/> Automatic day/night				
  	Navigation ↓ Secondary page ↓ Settings →	 Route settings				Enter settings and choose the volume for the voice and announcement of street names.	
		 Voice synthesis					
		 Alert!					
		 Traffic options					
		<input checked="" type="checkbox"/> Confirm					
					Save the options.		

05 NAVIGATION - GUIDANCE

Choosing a new destination

Towards a new destination

1

Press on **Navigation** to display the primary page then go to the secondary page.



2

Select "**Enter destination**".



3

Select "**Address**".



4

Select the "**Country:**" from the list offered then in the same way:
the "**City:**" or its post code, the "**Road:**",
the "**N°:**". Confirm each time.

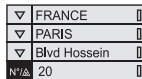



Select "**Save**" to save the address entered as a contact entry.
The system allows up to 200 entries.



5

Select "**Navigate to**".



6

Choose the navigation criteria: "**Fastest**" or "**Shortest**" or "**Time/distance**" or "**Ecological**".



7

Choose the restriction criteria: "**Include tollroads**", "**Include ferries**", "**Traffic**", "**Strict**", "**Close**".



8

Select "**Confirm**" or press "**Show route on map**" to start navigation guidance.



i

To delete navigation information, press on "**Settings**" then "**Stop navigation**".



To restore the navigation information press on "**Settings**" then "**Resume navigation**".



05 NAVIGATION - GUIDANCE

Towards a recent destination

1

Press on **Navigation** to display the primary page then go to the secondary page.



2

Select "**Enter destination**".



3

Select an address from the list offered.

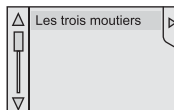

4

Select "**Navigate to**".
Select the criteria then "**Confirm**" or press "**Show route on map**" to start guidance.



Towards a contact

i

Navigation towards a contact imported from a telephone is only possible if the address entered is compatible with the system.

1

Press on **Navigation** to display the primary page then go to the secondary page.



2

Select "**Enter destination**".



3

Select "**Contacts**".



4

Select a destination from the contacts in the list offered.

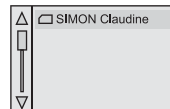

5

Select "**Navigate to**".
Select the criteria then "**Confirm**" to start guidance.



05 NAVIGATION - GUIDANCE

Towards GPS coordinates

1

Press on **Navigation** to display the primary page then go to the secondary page.



2

Select "**Enter destination**".



3

Select "**Address**".



4

Enter the "**Longitude:**" then the "**Latitude:**".

6°54'689"

5

Select "**Navigate to**".
Select the criteria then "**Confirm**" or press "**Show route on map**" to start guidance.



Towards a point on the map

1

Press on **Navigation** to display the primary page then go to the secondary page.



2

Select "**Enter destination**".



3

Select "**From map**".



4

Zoom in on the map then select the point.



5

A long press displays the surrounding tourist attractions.

05 NAVIGATION - GUIDANCE

Towards points of interest (POI)

Points of Interest (POI) show all of the locations of services nearby (hotels, retail outlet, airports, ...).

1

Press on **Navigation** to display the primary page then go to the secondary page.



2

Select "**Search for a point of interest**".



3

Select "**All POIs**" or "**Garage**" or "**Dining/hotels**" or "**Personal**" or "**By name**".



4

Select a category from the list offered.



5

Select "**Search**".



6

Select a point of interest from the list offered.

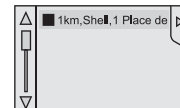

7

Select "**Navigate to**".



i

An annual mapping update allows new points of interest to be presented to you.
You can also update the Risk areas / Danger areas every month.
The detailed procedure is available on:
<http://peugeot.navigation.com>.

05 NAVIGATION - GUIDANCE

Towards points of interest (POI)

1

Press on **Navigation** to display the primary page then go to the secondary page.



2

Select "**Show POIs**".



3

Select a category from the list offered then "**Confirm**".



05 NAVIGATION - GUIDANCE

Risk area / Danger zone alert settings

1

Press on **Navigation** to display the primary page then go to the secondary page.



2

Select "**Settings**".



3

Select "**Alert config.**".



4

It is then possible to activate Risk Areas alerts then:

- "Audible warning"
- "Alert only when navigating"
- "Alert only for overspeed"
- "Display speed limits"
- Timing: the choice of timing allows the time before giving a Risk Area alert to be defined.

5

Select "**Confirm**".



!

These functions are only available if Risk Areas have been downloaded and installed on the system.

05 NAVIGATION - GUIDANCE

Adding a waypoint

- 1 Press on **Navigation** to display the primary page then go to the secondary page.



- 2 Select **"Enter destination"**.



- 3 Select **"Itinerary"**.



- 4 Select **"Add waypoint"** then **"Enter address"**.



- 5 The address of the waypoint is entered in the same way as a destination, so enter the **"City:"** or post code, the **"Road:"** and the **"N°:"**. Confirm each time. Then select **"Add waypoint"**.

▼	FRANCE	
▼	PARIS	
▼	Bldv Hossein	
N°/A	20	



- 6 Select **"Navigate to"**.
Select the criteria then **"Confirm"** to start guidance and give the general direction of the navigation route.



Organising waypoints

- 4 To organise waypoints, carry out the previous operations 1 to 3 again (Adding a waypoint).

- 5 Select the waypoint that you want to move in the order.



- 6a Select **"Up"**.



- 6b Select **"Down"**.



- 6c Select **"Delete"**.



- Select **"Road map"** to view the changes made to the route.



05 NAVIGATION - GUIDANCE

Route options

Calculation criteria

1

Press **Navigation** to display the primary page then go to the secondary page.



2

Select "**Settings**".



3

Select "**Criteria**".



4

It is then possible to choose:

- the navigation criteria: "**Fastest**", "**Shortest**", "**Time/distance**", "**Ecological**".
- the exclusion criteria: "**Include tollroads**", "**Include ferries**", "**Traffic**", "**Strict**", "**Close**".

5

Select "**Confirm**".



!

The ecological calculation is based on mapping data but this may not always be correct.

05 TRAFFIC

Traffic information

Display of messages

- 1 Press on **Navigation** to display the primary page then go to the secondary page.



- 2 Select "**Traffic messages**".



- 3 Set the "**On the route**", "**Around**", "**Near destination**" filters to fine-tune the list. Press again to remove the filter.



- 4 Select the message from the list offered. Select the magnifying glasses to have the information spoken.

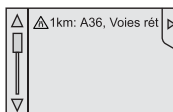

- i** TMC (Traffic Message Channel) messages contain information on traffic and weather conditions, received in real time and transmitted to the driver in the form of audible announcements and symbols on the navigation map.

Setting filters

- 1 Press on **Navigation** to display the primary page then go to the secondary page.



- 2 Select "**Settings**".



- 3 Select "**Info option**".



- 4 Select:
- "**Warn of new messages**",
- "**Speak messages**",
Then enter the filter radius.



- 5 Select "**Confirm**".



- i** We recommend a filter radius of:
- 12 miles (20 km) in urban areas,
- 30 miles (50 km) on motorways.

05 TRAFFIC

Main traffic symbols

1 Red and yellow triangle: traffic information, for example:



2 Black and blue triangle: general information, for example:

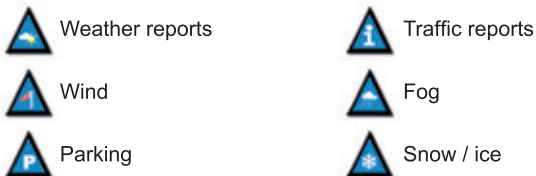

Receiving TA messages

1 Press on **Navigation** to display the primary page then go to the secondary page.



2 Select "**Settings**".



3 Select "**Voice**".



4 Activate / Deactivate "**Traffic (TA)**".



i The TA (Traffic Announcement) function gives priority to TA alert messages. To operate, this function needs good reception of a radio station transmitting this type of message. When a traffic report is transmitted, the current audio source (Radio, CD, USB, ...) is interrupted automatically to play the TA message. Normal playback of the audio source resumes at the end of the transmission of the message.

05 TRAFFIC

Diverting from a route

1

Press on **Navigation** to display the primary page then go to the secondary page.



2

Select "**Traffic messages**".



3

Select "**Diversion**".



4

Select the diversion distance by pressing + or -.



5

Select "**Recalculate route**". The route will be modified in time and distance.

+183 km +00:20

6

Select "**Confirm**".



The route may be diverted following the reception of a traffic information message.

05 MAP

Map settings

Map orientation

1

Press on **Navigation** to display the primary page then go to the secondary page.



2

Select "**Map settings**".



3

Select "**Orientation**".



4

Select:

- "**Flat view north heading**" to keep the map always North up,
- "**Flat view vehicle heading**" to have the map follow the direction of travel,
- "**Perspective view**" to display a perspective view.



5

Select "**Confirm**" to save the modifications.



05 MAP

Configure

1

Press on **Navigation** to display the primary page then go to the secondary page.



2

Select **"Map settings"**.



3

Select **"Aspect"**.



4

Select:

- **"Day" map colour** to have the map always in day mode.
- **"Night" map colour** to have the map always in night mode.
- **"Automatic day/night"** to have the brightness of the map adjusted automatically according to the ambient light level.



This mode makes use of the vehicle's sunshine sensor or by manual operation of the vehicle's lighting.

5

Then **"Confirm"** to save the modifications.



Street names are visible on the map from the 100 m scale.

05 SETTINGS

Navigation speech synthesis

Volume / Street names

1

Press on **Navigation** to display the primary page then go to the secondary page.



2

Select "**Settings**".



3

Select "**Voice**".



4

Select "**Voice synthesis**" and/or "**Male voice**" and/or "**Female voice**" and/or "**Speak road names**".











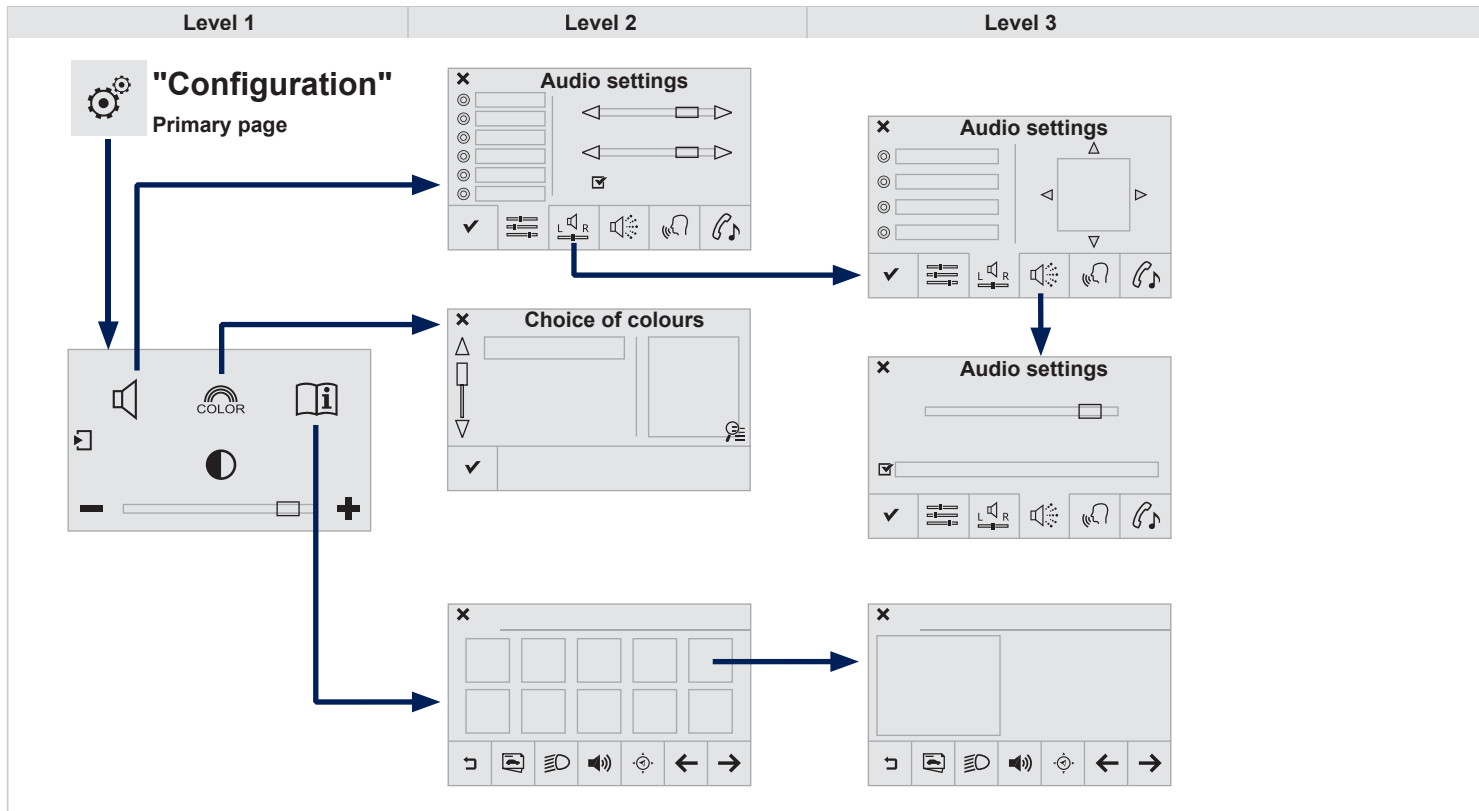











5

Select "**Confirm**" to save the modifications.











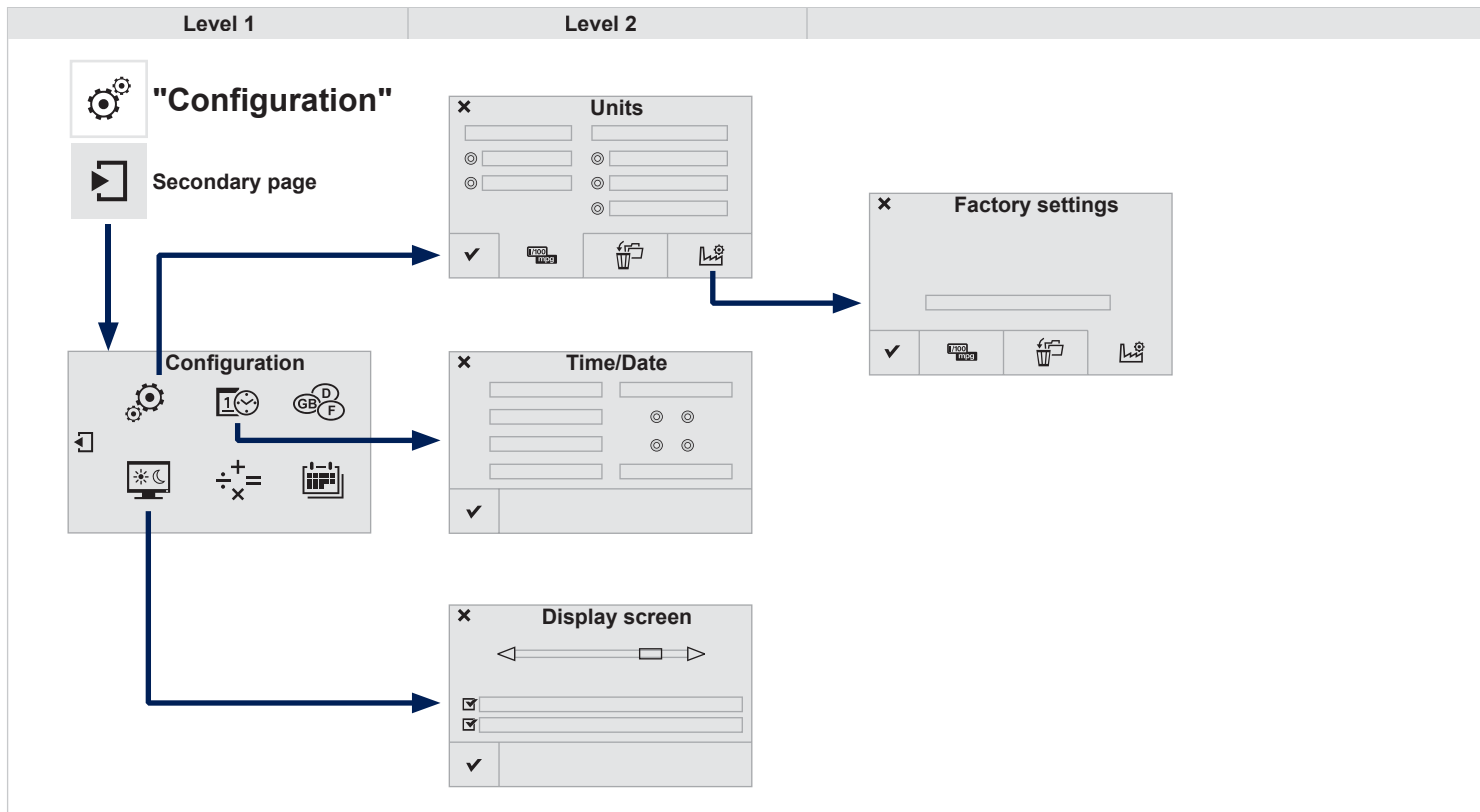





06 CONFIGURATION



Level 1		Level 2		Level 3	Comments
 	Configuration ↓ Audio settings ↓ Audio settings →		Ambience		Choose the sound ambience.
			Balance		Set the position of the sound in the vehicle using the Arkamys system.
			Sound effects		Choose the volume or activate the link to vehicle speed.
			Voice		Choose the volume for the voice and announcement of street names.
			Ringtones		Choose the telephone ringtone and volume.
			Confirm		Save the settings.
 	Configuration ↓ Color ↓ Choice of colour scheme →		Confirm		After choosing the colour scheme, save the setting.
 	Configuration ↓ Interactive help →		Go back		Consult the Interactive help.
			Driving assistance - Equipment		
			Warning lamps		
			Media Audio		
			Navigation GPS		
			Previous page		
			Next page		

06 CONFIGURATION



Level 1		Level 2		Comments
  	Configuration ↓ Secondary page ↓ System Configuration →	 Units	Set the units used to display distance, fuel consumption and temperature.	
		 Erase data	Select the desired data in the list then press Delete.	
		 Factory settings	Return to factory settings.	
		<input checked="" type="checkbox"/> Confirm	Save the settings.	
  	Configuration ↓ Secondary page ↓ Time/Date →	<input checked="" type="checkbox"/> Confirm	Set the date and time then confirm.	
  	Configuration ↓ Secondary page ↓ Screen settings →	 Brightness <input checked="" type="checkbox"/> Automatic text scrolling <input checked="" type="checkbox"/> Deactivate animations <input checked="" type="checkbox"/> Validate	Make the setting then confirm.	







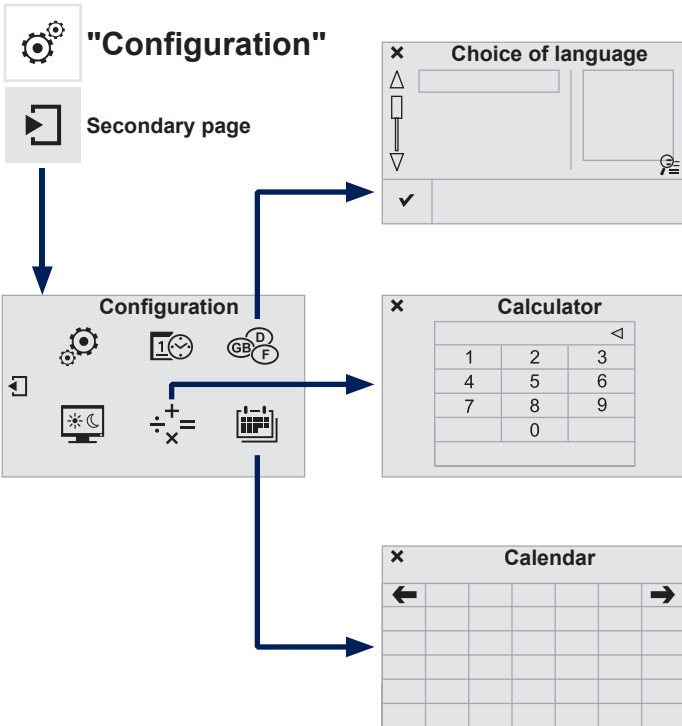

06 CONFIGURATION



Level 1

Level 2



Level 1		Level 2		Comments
  	<p>Configuration</p> <p>↓</p> <p>Secondary page</p> <p>↓</p> <p>System languages</p> <p>→</p>	✓	Confirm	Select the language then confirm.
  	<p>Configuration</p> <p>↓</p> <p>Secondary page</p> <p>↓</p> <p>Calculator</p> <p>→</p>			Select the calculator.
  	<p>Configuration</p> <p>↓</p> <p>Secondary page</p> <p>↓</p> <p>Calendar</p> <p>→</p>			Select the calendar.

06 CONFIGURATION

Audio settings

1 Press on **Configuration** to display the primary page.



2 Select "**Audio settings**".



3 Select "**Ambience**" or "**Balance**" or "**Sound effects**" or "**Voice**" or "**Ringtones**".

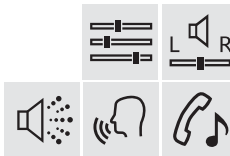

! The distribution (or spatialisation using the Arkamys® system) of sound is an audio process that allows the audio quality to be adapted to the number of listeners in the vehicle.

! The audio settings (**Ambience**, **Bass**, **Treble** and **Loudness**) are different and independent for each sound source.
The settings for **distribution** and **balance** are common to all sources.

- ! - "**Ambience**" (choice of 6 musical ambiances)
- "**Bass**"
- "**Treble**"
- "**Loudness**" (Activate/Deactivate)
- **Balance** ("**Surround**", "**Driver**", "**All passengers**", "**Front only**", "**ByPass**")
- "**Audio setting on touch screen**"
- "**Volume linked to vehicle speed:**" (Activate/Deactivate)

i On-board audio: Arkamys® Sound Staging.
With Sound Staging, the driver and passengers are immersed in an "audio scene" recreating the natural atmosphere of an auditorium: truly a part of the scene and its surroundings.
This new sensation is made possible by software in the audio system which processes the digital signals from the media players (radio, CD, MP3...) without changing the audio settings. This processing takes account of the characteristics of the passenger compartment to produce optimum results.
The Arkamys® software installed in your audio system processes the digital signal from the media players (radio, CD, MP3, ...) and recreates a natural musical scene, with harmonious placement of instruments and voices in the space in front of passengers, level with the windscreen.

06 CONFIGURATION

Colour schemes

1

Press on **Configuration** to display the primary page.



2

Select "**Colour schemes**".



3

Select the colour scheme in the list then "**Confirm**".



i

At each change of colour scheme the touch screen tablet's system restarts, showing a black screen for a few moments.

!

For safety reasons, the procedure for changing the colour scheme is only possible with the vehicle stationary.

Interactive help

1

Press on **Configuration** to display the primary page.



2

Select "**Interactive help**".



i

The interactive version of your user guide available in this touch screen is not intended as a substitute for the more complete content of the printed document.

!

For safety reasons, consultation of your user guide is only possible with the vehicle stationary.

06 CONFIGURATION

System

Modify system settings

- 1 Press on **Configuration** to display the primary page then go to the secondary page.



- 2 Select "**System configuration**".



- 3 Select "**Units**" to change the units of distance, fuel consumption and temperature.



- 4 Select "**Delete data**" to delete the list of recent destinations, personal points of interest, contacts in the list.
Choose the item then select "**Delete**".



- 5 Select "**Factory settings**" to return to the original settings.



- 1 Press on **Configuration** to display the primary page then go to the secondary page.



- 2 Select "**Screen settings**".



- 3 Select "**Brightness**" to switch off the screen or adjust the brightness.
Activate or deactivate "**Activate automatic text scrolling**" and "**Activate animations**".



06 CONFIGURATION

1

Press on **Configuration** to display the primary page then go to the secondary page.



2

Select:

- **"Time/Date"** to change the time zone, synchronisation with GPS, time and its format and then the date.
- **"Languages"** to change the language.
- **"Calculator"** to display a calculator
- **"Calendar"** to display a calendar.



07 CONNECTED SERVICES



Level 1

Level 2

"Connected services"

Primary page:
Driving assistance applications, see following page on "PEUGEOT CONNECT APPS".

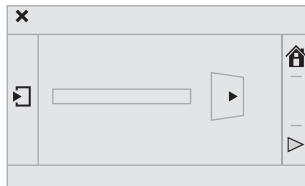

Secondary page:
Internet navigation via Bluetooth telephone Dial-Up Networking (DUN).

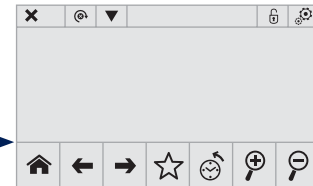
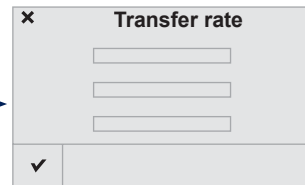
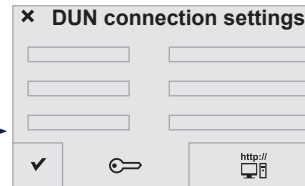
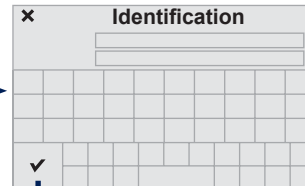
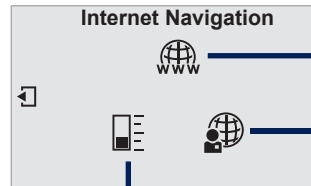

It may be that certain new generation smartphones are not compatible with this standard.

* Depending on country.

07 PEUGEOT CONNECT APPS

! "PEUGEOT CONNECT APPS" is a service providing driving aid applications in real time, that gives access to useful information such as the state of the traffic, danger zones, fuel prices, the availability of parking places, tourist sites, weather conditions, correct addresses...

It includes access to the mobile network associated with the use of these applications. "PEUGEOT CONNECT APPS" is a service available under subscription contract from PEUGEOT dealers, depending on country and the type of touch screen, both before and after delivery of a new vehicle.

- 1 Connect the "PEUGEOT CONNECT APPS" key to the USB port located in the glove box.

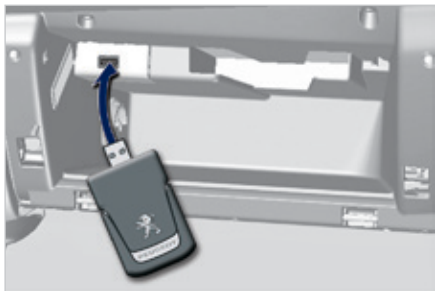

- 2 Press the "Connected services" menu to display the applications.

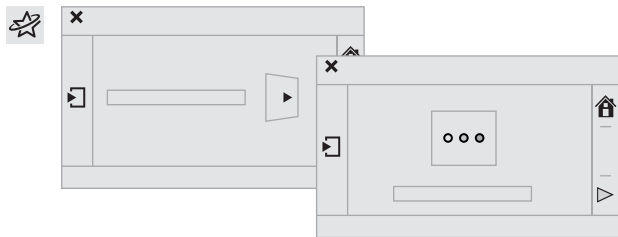

3



These applications use vehicle data such as the current speed, mileage, remaining fuel range or even GPS position to provide pertinent information.

!

For safety reasons, some functions can only be used when stationary.

☀









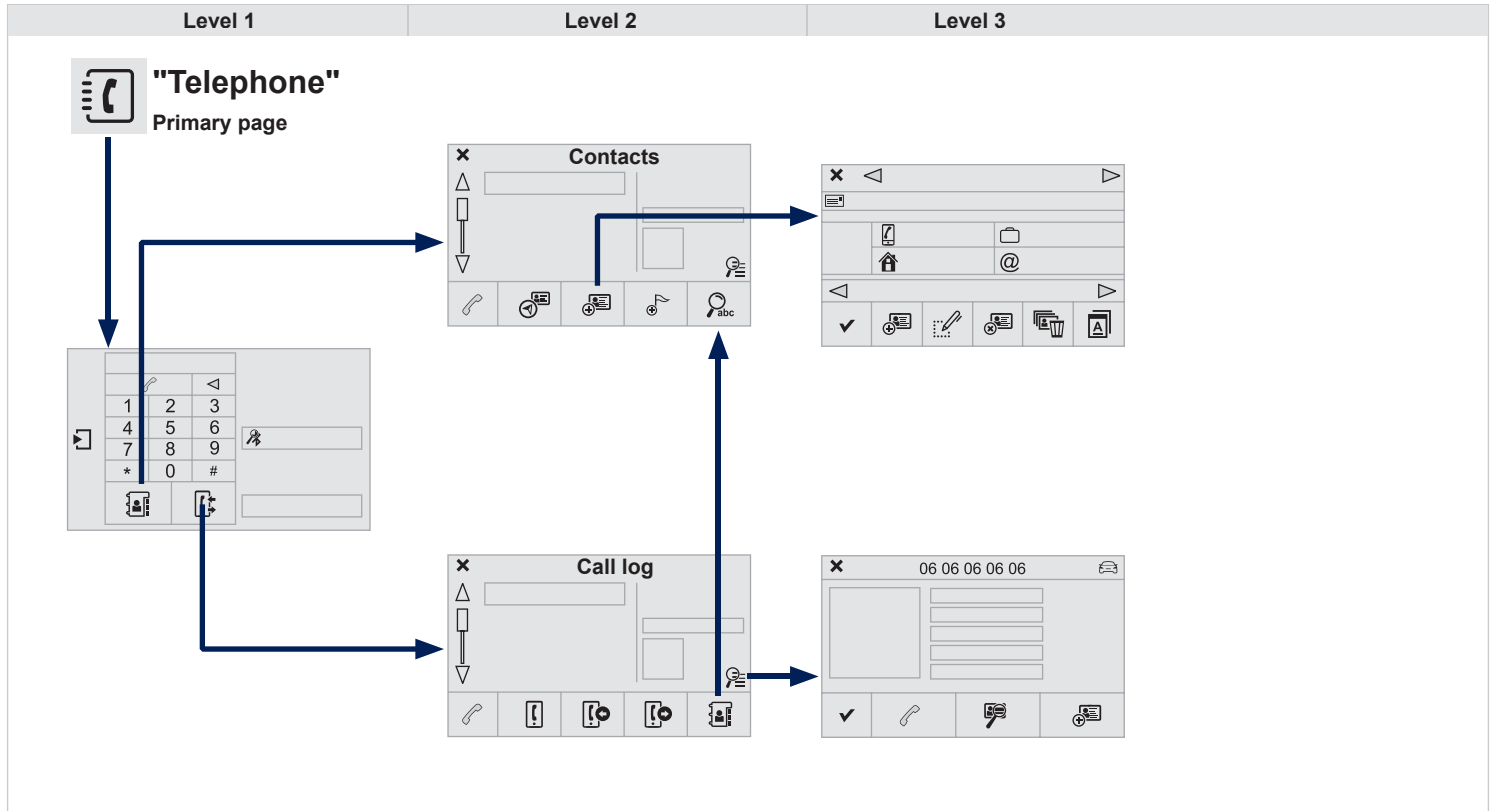













The "MyPeugeot" application is a link between the user, the manufacturer and its dealer network.

It allows the customer to know everything about their vehicle: servicing plan, accessory range, service contracts taken out, ...

It also makes possible the sending of the vehicle's mileage to the "MyPeugeot" site, or to identify a dealer.

08 TELEPHONE











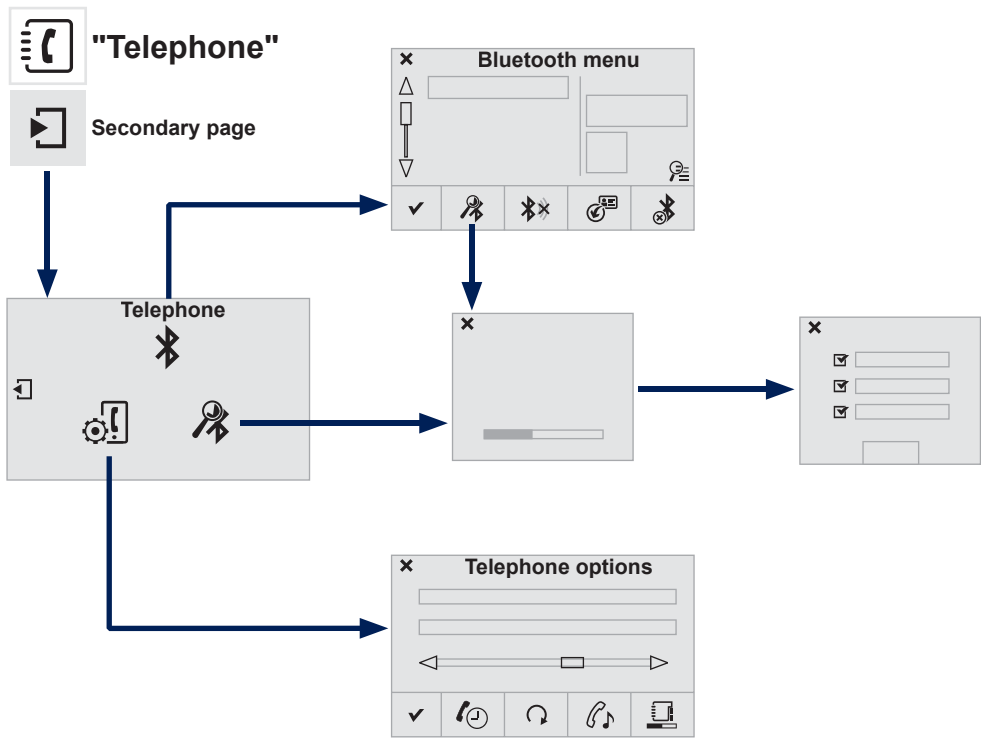











Level 1		Level 2		Level 3		Comments
 	Telephone ↓ Contacts →	 Addresses				After making choices, start the call.
		 Add contact	 New			
			 Modify			
			 Delete			
			 Delete all			
			 Search for contact			
			 Confirm			
	 Add waypoint					
	 By name					
	 Call					
 	Telephone ↓ Call log →	 All calls				After making choices, start the call.
		 Incoming calls				
		 Outgoing calls				
		 Contact				
		 Magnifying glass	 View contact			
			 New			
			 Call			

08 TELEPHONE



Level 1 Level 2 Level 3



Level 1		Level 2		Level 3		Comments
  	Telephone ↓ Secondary page ↓ Bluetooth menu →	 Search				Start the search for another peripheral device to connect.
		 Disconnect				Stop the Bluetooth connection to the selected peripheral device.
		 Update				Import the contacts from the selected telephone to store them in the audio system.
		 Delete				Delete the selected telephone.
		 Confirm				Save the settings.
  	Telephone ↓ Secondary page ↓ Search for devices →		<input checked="" type="checkbox"/>	Telephone profile		Start the search for peripheral devices.
			<input checked="" type="checkbox"/>	Streaming profile		
			<input checked="" type="checkbox"/>	Internet profile		
  	Telephone ↓ Secondary page ↓ Telephone options →	 Put on hold				Cut the microphone temporarily so that the contact cannot hear your conversation with a passenger.
		 Update				Import the contacts from the selected telephone to save them in the audio system.
		 Choice of ringtone:				Choose the telephone ringtone and volume.
		 Memory info.				Contact records used and free, percentage of storage space used by internal contacts and Bluetooth contacts.
		 Confirm				Save the settings.

08 BLUETOOTH

Pairing a Bluetooth telephone First connection

- 1 Activate the telephone's Bluetooth function and ensure that it is "visible to all" (telephone configuration).



- 2 Press on **Telephone** to display the primary page then go to the secondary page.



- 3 Select the "**Bluetooth**" menu.



- 4 Select **Search**.
The list of telephones detected is displayed.



- i** If the telephone is not detected, it is recommended that you switch the Bluetooth function on your telephone off and then on again.

- 5 Select the name of the desired peripheral from the list and **Confirm**.



- !** For reasons of safety and because they require prolonged attention on the part of the driver, the operations for pairing the Bluetooth mobile telephone to the hands-free system of the audio system must be carried out with the **vehicle stationary**.

- 6 Choose a code for the connection then "**Confirm**".



- 7 Enter the same code on the telephone then accept the connection.



- 8 The system offers to connect the telephone:
- in "**Telephone profile**" (hands-free kit, telephone only),
 - in "**Streaming profile**" (streaming: wireless playing of audio files from the telephone),
 - in "**Internet profile**" (internet browsing, only if your telephone is compatible with the "DUN" Dial-Up Networking Bluetooth standard).
- Select one or more profiles and Confirm.

- !** The ability of the system to connect with only one profile depends on the telephone. The two profiles may both connect by default.

- ☀** Visit www.peugeot.co.uk for more information (compatibility, additional help, ...).

08 BLUETOOTH



The services available depend on the network, the SIM card and the compatibility of the Bluetooth telephone used. Check the telephone manual and with your network provider for details of the services available to you.

9

The telephone is added to the list.



10

Depending on your telephone, you may be asked to accept automatic connection every time the ignition is switched on.



Depending on the type of telephone, the system will ask you to accept or not the transfer of your contacts.



If not, select "**Update**".



On return to the vehicle, the last telephone connected automatically reconnects, within around 30 seconds after switching on the ignition (Bluetooth activated).

To modify the automatic connection mode, select the telephone in the list then select the desired profile.

Connecting a Bluetooth peripheral

Automatic reconnection

1

On switching on the ignition, the telephone connected when the ignition was last switched off is automatically reconnected, if this connection mode had been activated during the pairing procedure (see previous pages).

2

The connection is confirmed by the display of a message and the name of the telephone.

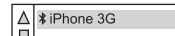

Manual connection

1

Press on **Telephone** to display the primary page then go to the secondary page.



2

Select "**Bluetooth**" to display the list of paired peripherals.



3

Select the peripheral to connect.



4

Press on "**Search**".



5

The connection is confirmed by the display of a message and the name of the telephone.

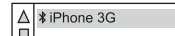

08 BLUETOOTH

Managing paired telephones

i This function allows the connection or disconnection of a peripheral device as well as the deletion of a pairing.

1 Press on **Telephone** to display the primary page then go to the secondary page.



2 Select "**Bluetooth**" to display the list of paired peripheral devices.



3 Select the peripheral in the list.

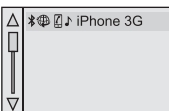

4 Select:

- "**Search**" or "**Disconnect**" to connect or disconnect the Bluetooth connection with the peripheral selected.
- "**Delete**" to remove the pairing.



Receiving a call

1 An incoming call is announced by a ring and a superimposed display in the screen.

2a Make a short press on the steering mounted **TEL** button to accept an incoming call.



2b Make a long press on the steering mounted **TEL** button to reject the call.
or
Select "**End call**".



08 CONTACTS

Making a call

Calling a new number

- 1 Press on **Telephone** to display the primary page.



- 2 Enter the phone number using the keypad then **"Call"** to start the call.



! Use of the telephone is not recommended while driving. We recommend that you park safely or make use of the steering mounted controls.

Calling a contact

- 1 Press on **Telephone** to display the primary page.



Or make a long press on the steering mounted **TEL** button.



- 2 Select **"Contacts"**.



- 3 Select the desired contact from the list offered.

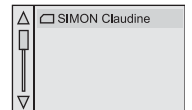

- 4 Select **"CALL"**.



08 CALL LOG

Calling a recently used number

1

Press on **Telephone** to display the primary page.



2

Select "**Call log**".



3

Select the desired contact from the list offered.

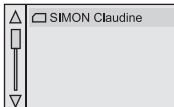

i

It is always possible to make a call directly from the telephone; park the vehicle first as a safety measure.

Ending a call

1a

Select "**End call**".



or

1b

Make a long press on the steering mounted **TEL** button.



08 SETTINGS

Ringtones

1

Press on **Telephone** to display the primary page then go to the secondary page.



2

Select "**Telephone options**".



3

Select "**Choice of ringtone:**".



4

You can select the ringtone used and adjust its volume.

5

Select "**Confirm**".



Managing contacts / Entries

1

Press on **Telephone** to display the primary page.



2

Select "**Contacts**".



3

Select "**View contact**".



4

Select:

- "**New**" to add a new contact.
- "**Modify**" to edit the selected contact.
- "**Delete**" to delete the selected contact.
- "**Delete all**" to delete all of the information for the selected contact.

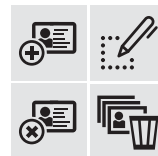

Select "**Directory information**" for the number of entries used, available, ...



FREQUENTLY ASKED QUESTIONS

The following table groups together the answers to the most frequently asked questions concerning your audio system.

QUESTION	ANSWER	SOLUTION
Navigation, guidance		
The route calculation is not successful.	The guidance criteria may conflict with the current location (exclusion of toll roads on a toll motorway).	Check the guidance criteria on the Navigation Menu, "Guidance options" \ "Define calculation criteria".
I am unable to enter my post code.	The system only accepts post codes of up to 5 characters.	
The POIs do not appear.	The POIs have not been selected.	Select the POIs in the list of POIs.
The risk areas audible warning does not work.	The audible warning is not active.	Activate audible warnings in the Guidance options menu, "Navigation - guidance", "Set parameters for risk areas".
The system does not suggest a detour around an incident on the route.	The guidance criteria do not take account of TMC messages.	Select the "Traffic info" function in the list of guidance criteria.
I receive a Risk area alert which is not on my route.	Other than guidance, the system announces all Risk areas positioned in a cone located in front of the vehicle. It may provide an alert for a Risk area located on nearby or parallel roads.	Zoom in on the map to view the exact position of the Risk area. Select "On the route" to no longer receive alerts other than guidance or to reduce the time for the announcement.

FREQUENTLY ASKED QUESTIONS

QUESTION	ANSWER	SOLUTION
Certain traffic jams along the route are not indicated in real time.	On starting, it is several minutes before the system begins to receive the traffic information.	Wait until the traffic information is being received correctly (display of the traffic information icons on the map).
	The filters are too restrictive.	Modify the "Geographic filter" settings.
	In certain countries, only major routes (motorways...) are listed for the traffic information.	This phenomenon is normal. The system is dependent on the traffic information available.
The altitude is not displayed.	On starting, the initialisation of the GPS may take up to 3 minutes to receive more than 4 satellites correctly.	Wait until the system has started up completely. Check that there is a GPS coverage of at least 4 satellites (long press on the SETUP button, then select "GPS coverage").
	Depending on the geographical environment (tunnel...) or the weather, the conditions of reception of the GPS signal may vary.	This phenomenon is normal. The system is dependent on the GPS signal reception conditions.
Telephone, Bluetooth		
I cannot connect my Bluetooth telephone.	The telephone's Bluetooth function may be switched off or the telephone may not be visible.	<ul style="list-style-type: none"> - Check that your telephone's Bluetooth function is switched on. - Check in the telephone settings that it is "visible to all".
	The Bluetooth telephone is not compatible with the system.	You can check the compatibility of your telephone at www.peugeot.co.uk (services).
The volume of the telephone connected in Bluetooth mode is inaudible.	The volume depends both on the system and on the telephone.	Increase the volume of the audio system, to maximum if required, and increase the volume of the telephone if necessary.
	The ambient noise level has an influence on the quality of telephone communication.	Reduce the ambient noise level (close the windows, reduce the booster fan speed, slow down, ...).

FREQUENTLY ASKED QUESTIONS

QUESTION	ANSWER	SOLUTION
Some contacts are duplicated in the list.	The options for synchronizing contacts are synchronizing the contacts on the SIM card, the contacts on the telephone, or both. When both synchronizations are selected, some contacts may be duplicated.	Select "Display SIM card contacts" or "Display telephone contacts".
Contacts are not shown in alphabetical order.	Some telephones offer display options. Depending on the settings chosen, contacts can be transferred in a specific order.	Modify the display setting in the telephone directory.
The system does not receive SMS text messages.	The Bluetooth mode does not permit sending SMS text messages to the system.	
CD, MP3		
The CD is ejected automatically or is not played by the player.	<p>The CD is inserted upside down, is unplayable, does not contain any audio data or contains an audio format which the player cannot play.</p> <p>The CD has been recorded in a format that is not compatible with the player (udf, ...).</p> <p>The CD is protected by an anti-pirating protection system which is not recognised by the audio system.</p>	<ul style="list-style-type: none"> - Check that the CD is inserted in the player the right way up. - Check the condition of the CD: the CD cannot be played if it is too damaged. - Check the content in the case of a recorded CD: refer to the advice in the "AUDIO" section. - The audio system's CD player does not play DVDs. - Some recorded CDs will not be played by the audio system because they are not of the correct quality.
There is a long waiting period following the insertion of a CD or connection of a USB memory stick.	When a new medium is inserted, the system reads a certain amount of data (directory, title, artist, etc.). This may take from a few seconds to a few minutes.	This phenomenon is normal.
The CD player sound is poor.	The CD used is scratched or of poor quality.	Insert good quality CDs and store them in suitable conditions.
	The audio equipment settings (bass, treble, ambiences) are unsuitable.	Set the treble or bass level to 0, without selecting an ambience.

FREQUENTLY ASKED QUESTIONS

QUESTION	ANSWER	SOLUTION
Some characters in the media information are not displayed correctly while playing.	The audio system does not display some types of characters.	Use standard characters to name tracks and folders.
Playing of streaming files does not start.	The peripheral device connected does not support automatic play.	Start the playback from the device.
The names of tracks and the track length are not displayed on the screen when streaming audio.	The Bluetooth profile does not allow the transfer of this information.	
Radio		
The quality of reception of the radio station listened to gradually deteriorates or the stored stations do not function (no sound, 87.5 Mhz is displayed...).	The vehicle is too far from the transmitter used by the station listened to or there is no transmitter in the geographical area through which the vehicle is travelling.	Activate the "RDS" function by means of the short-cut menu to enable the system to check whether there is a more powerful transmitter in the geographical area.
	The environment (hills, buildings, tunnels, basement car parks...) block reception, including in RDS mode.	This phenomenon is normal and does not indicate a fault with the audio system.
	The aerial is absent or has been damaged (for example when going through a car wash or into an underground car park).	Have the aerial checked by a PEUGEOT dealer.
I cannot find some radio stations in the list of stations received.	The station is not received or its name has changed in the list.	
	Some radio stations send other information in place of their name (the title of the song for example).	
The name of the radio station changes.	The system interprets this information as the name of the station.	

FREQUENTLY ASKED QUESTIONS

QUESTION	ANSWER	SOLUTION
Settings, configuration		
In changing the setting of treble and bass the equalizer setting is deselected.	The selection of an equalizer setting imposes the balance settings. Modifying one without the other is not possible.	Modify the balance or equalizer settings to obtain the desired musical ambience.
In changing the equalizer setting, treble and bass return to zero.		
When changing the balance settings, the distribution setting is deselected.	The selection of a distribution setting imposes the balance settings. Modifying one without the other is not possible.	Modify the balance or distribution settings to obtain the desired musical ambience.
When changing an distribution setting, the balance setting is deselected.		
There is a difference in sound quality between the different audio sources (radio, CD...).	For optimum sound quality, the audio settings for Volume, Bass, Treble, Equalizer and Loudness can be adapted to the different sound sources, which may result in audible differences when changing source (radio, CD...).	Check that the audio settings for (Volume, Bass, Treble, Equalizer, Loudness) are adapted to the sources listened to. It is advisable to set the AUDIO functions (Bass, Treble, Fr-Re balance, Le-Ri balance) to the middle position, select the "None", musical ambience and set the loudness correction to the "Active" position in CD mode or to the "Inactive" position in radio mode.

FREQUENTLY ASKED QUESTIONS

QUESTION	ANSWER	SOLUTION
<p>With the engine off, the system switches off after a few minutes of use.</p>	<p>When the engine is switched off, the system's operating time depends on the battery charge.</p> <p>The switch-off is normal: the system switches to economy mode and switches off to prevent discharging of the vehicle's battery.</p>	<p>Start the vehicle's engine to increase the battery charge.</p>
USB, portable player, connection key		
<p>Playback of my USB memory stick starts only after a very long wait (around 2 to 3 minutes).</p>	<p>Some files supplied with the memory stick may greatly slow down access to reading the memory stick (multiplication by 10 of the catalogue time).</p>	<p>Delete the files supplied with the memory stick and limit the number of sub-folders in the file structure on the memory stick.</p>
<p>When I connect my iPhone as telephone and to the USB port at the same time, I am unable to play the music files.</p>	<p>When the iPhone connects automatically as a telephone, it forces the streaming function. The streaming function takes the place of the USB function which is then not useable, there is a period without sound of the track being played with Apple® players.</p>	<p>Disconnect and reconnect to the USB port (the USB function takes priority over streaming).</p>

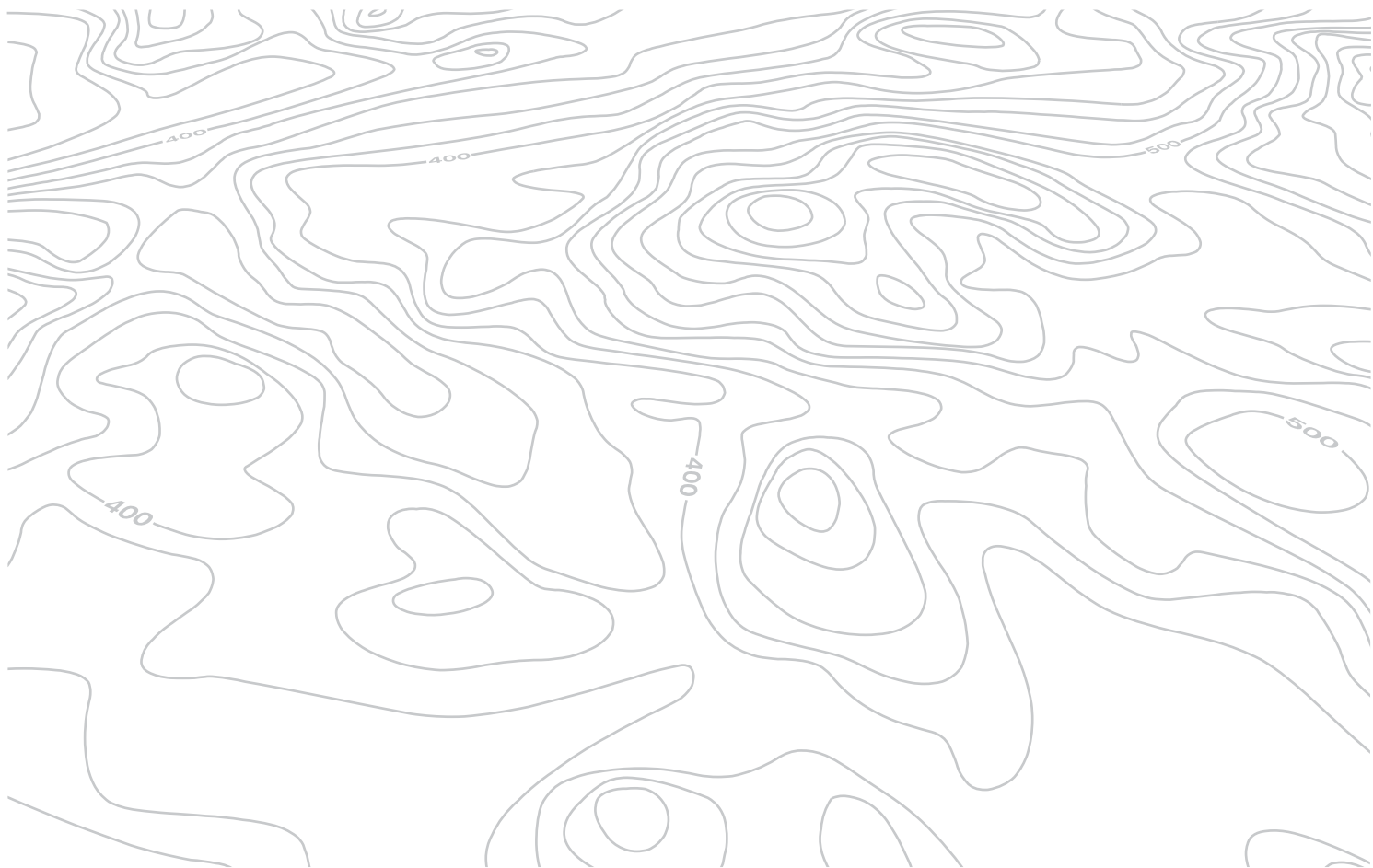



PEUGEOT Connect Sound (RD5)

AUDIO SYSTEM / BLUETOOTH®



Your PEUGEOT Connect Sound (RD5) is coded in such a way that it will only operate in your vehicle.



For safety reasons, the driver must only carry out operations which require prolonged attention while the vehicle is stationary.

When the engine is switched off and to prevent discharging of the battery, the audio equipment may switch off after a few minutes.

CONTENTS

01	First steps	p.	366
02	Steering mounted controls	p.	367
03	Main menu	p.	368
04	Audio	p.	369
05	PEUGEOT Connect USB	p.	374
06	Bluetooth	p.	377
07	Screen menu map(s)	p.	380
	Frequently asked questions	p.	383

01 FIRST STEPS

TA (Traffic Announcements) on/off.

Select wavebands FM1, FM2, FMast and AM.

Select source: radio, audio CD / MP3 CD, USB, Jack connection, Streaming, AUX.

Audio settings: front/rear fader, left/right balance, bass/treble, loudness, audio ambiances.

Select the screen display mode: date, audio functions, telephone, Bluetooth, personalisation-configuration.

On/off, volume setting.

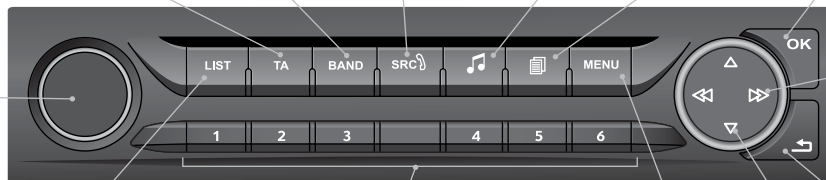

Confirm.

Automatic frequency search down/up.
Select previous/next CD, MP3 or USB track.

Abandon the current operation.

Display the list of local stations.
Long press: CD tracks or MP3 folders (CD / USB).

Buttons 1 to 6:
Select a pre-set radio station.
Long press: pre-set a station.

Display main menu.

Select next frequency down/up.
Select previous/next MP3 folder.
Select previous/next folder / genre / artist / playlist (USB).

02 STEERING MOUNTED CONTROLS

Radio: automatic search for a higher frequency.
CD / MP3 / USB: selection of the next track.
CD / USB: continuous press: fast forwards play.
Move in the list.



Change audio source.
Confirm a selection.
Call/end call on the telephone.
Press for more than 2 seconds:
telephone main menu.

Radio: select the previous/next pre-set station.
USB: select genre / artist / folder from the classification list.
Select the previous/next item in a menu.

Radio: automatic search for a lower frequency.
CD / MP3 / USB: selection of the previous track.
CD / USB: continuous press: fast reverse.
Move in the list.

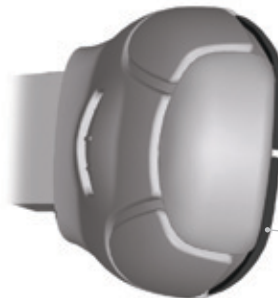

Volume increase.

Volume decrease.

Mute: press the volume increase and decrease buttons simultaneously.
The sound is restored by pressing one of the two volume buttons.

03 MAIN MENU

Screen C

"**Multimedia**": Media parameters, Radio parameters.

"**Personalisation-configuration**": Define the vehicle parameters, Choice of language, Display configuration, Choice of units, Date and time adjustment.

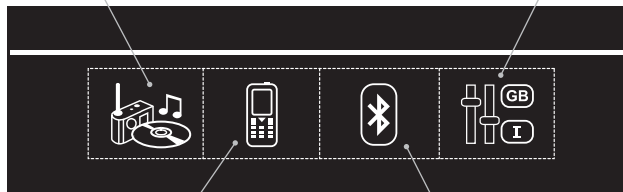

"**Telephone**": Call, Directory management, Telephone management, Hang up.

"**Bluetooth connection**": Connections management, Search for a device.







Screen A

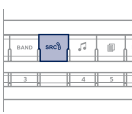

For a detailed global view of the menus available, refer to "Screen menu map" section.

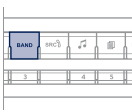
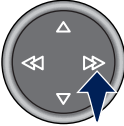
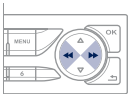

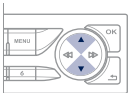

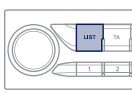

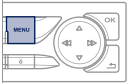

04 AUDIO

Radio Selecting a station

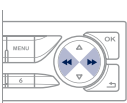
1		Press the SRC button several times in succession and select the radio.	
2		Press the BAND button to select a waveband: FM1, FM2, FMast, AM.	
3		Briefly press one of the buttons to carry out an automatic search of the radio stations.	
4		Press one of the buttons to carry out a manual search up / down for radio frequencies.	
		Press the LIST button to display the list of stations received locally (30 stations maximum). To update this list, press for more than two seconds.	

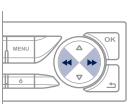
The external environment (hills, buildings, tunnels, basement car parks, ...) may block reception, including in RDS mode. This is a normal effect of the way in which radio waves are transmitted and does not indicate any failure of the audio system.

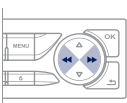
RDS

1		Press the MENU button.	
2		Select AUDIO FUNCTIONS then press OK.	
3		Select the FM WAVEBAND PREFERENCES function then press OK.	
4		Select ACTIVATE RDS then press OK. RDS appears on the screen.	
		In radio mode, press OK directly to activate / deactivate RDS mode.	
		The RDS, if displayed, enables you to continue listening to the same station by automatic retuning to alternative frequencies. However, in certain conditions, coverage of an RDS station may not be assured throughout the country as radio stations do not cover 100 % of the territory. Under conditions of very weak reception, the system may change to a regional station.	

04 AUDIO

Receiving TA messages



The TA (Traffic Announcement) function gives priority to TA alert messages. To operate, this function needs good reception of a radio station transmitting this type of message. When a traffic report is transmitted, the current audio source (Radio, CD, ...) is interrupted automatically to play the TA message. Normal playback of the audio source resumes at the end of the transmission of the message.

1



Press the TA button to activate or deactivate traffic messages.

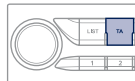

CD Playing a CD



Insert only compact discs of standard size. Some anti-pirating systems, on original discs or CDs copied using a personal recorder, may cause faults which are no reflection on the quality of the original player. Without pressing the EJECT button, insert a CD in the player, play begins automatically.

1



To play a disc which has already been inserted, press the SRC button several times in succession and select CD.

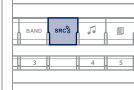

2

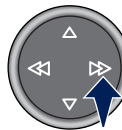

Press one of the buttons to select a track on the CD.

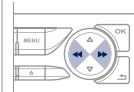

Press the LIST button to display the list of tracks on the CD.

3

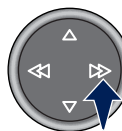

Press and hold one of the buttons for fast forwards or fast backwards.



04 AUDIO

MP3 CD Playing an MP3 compilation



Insert an MP3 compilation in the player.
The audio equipment searches for all of the music tracks, which may take anything between a few seconds and several tens of seconds, before play begins.



On a single disc, the CD player can read up to 255 MP3 files spread over 8 folder levels. However, it is advisable to keep to a limit of two levels to reduce the access time before the CD is played.
While the CD is being played, the folder structure is not followed. All of the files are displayed on a single level.

1



To play a disc which has already been inserted, press the SRC button several times in succession and select CD.



2



Press one of the buttons to select a folder on the CD.
Press one of the buttons to select a track on the CD.

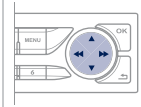

Press the LIST button to display the list of directories of the MP3 compilation.

3



Press and hold one of the buttons for fast forward or backward play.

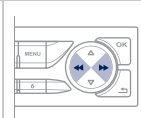

MP3 CD Information and advice



The MP3 format, an abbreviation of MPEG 1.2 & 2.5 Audio Layer 3, is an audio compression standard which permits the recording of several tens of music files on a single disc.



In order to be able to play a recorded CDR or CDRW, when recording, the ISO 9660 level 1.2 or Joliet file format is recommended.
If the disc is recorded in another format, it may not be played correctly.
It is recommended that the same recording format is always used for an individual disc, with as low a speed as possible (4x maximum) for optimum sound quality.
In the particular case of a multi-session CD, the Joliet format is recommended.



The audio system will only play files with the extension ".mp3" with a sampling rate of 22.05 KHz or 44.1 KHz. No other type of file (.wma, .mp4, .m3u...) can be played.



It is advisable to restrict file names to 20 characters without using special characters (e.g. " ? ; ù) to avoid any playing or displaying problems.



Empty CDs are not recognised and may damage the system.

04 AUDIO

Display options:
if active but not available, the display will
be struck out.



If the "DAB" station being listened
to is not available on "FM", "DAB
FM" is struck out.



Display the name of the current
station.

Preset stations, buttons 1 to 6.
Short press: select the preset radio
station.
Long press: preset a radio station.

Display the name of the multiplex
service being used.

Represents the signal strength for
the band being listened to.

Display of RadioText (TXT) for the
current radio station.

04 AUDIO

DAB (Digital Audio Broadcasting) Digital radio

- i** Digital radio provides a superior audio quality and also additional categories of traffic announcements (TA INFO).
The different "multiplex services" offer a choice of radio stations in alphabetical order.



Change band (FM1, FM2, DAB, ...).



Change of station within the same "multiplex service".



Start a search for the next "multiplex service".



Long press: select the desired categories of announcements from Transport, News, Entertainment and Flash special (availability according to the station).



When the radio station is displayed in the screen, press on "OK" to display the contextual menu.
(Frequency hopping (RDS), DAB / FM auto tracking, RadioText (TXT) display, Information on the station, ...)

Digital radio - DAB / FM tracking

- i** "DAB" does not have 100% coverage of the country.
When the digital signal is weak, "DAB / FM auto tracking" allows you to continue listening to the same station, by automatically switching to the corresponding analogue "FM" station (if it exists).

1



Press the "Menu" button.

2

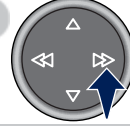

Select "Multimedia" and confirm.

3

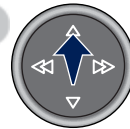

Select "DAB / FM auto tracking" and confirm

- i** If "DAB / FM auto tracking" is on, there will be a difference of a few seconds in the programme when the system changes to analogue "FM" radio, with sometimes a variation in volume.
When the strength of the digital signal is good again, the system automatically switches back to "DAB"

- !** If the "DAB" station you are listening to is not available on "FM" ("DAB/FM" option barred), or if "DAB / FM auto tracking" is not on, the sound will be cut when the digital signal is too weak.

05 PEUGEOT CONNECT USB

Using the PEUGEOT CONNECT USB

1

This unit consists of a USB port and an auxiliary Jack socket*. The audio files are transmitted from a portable device - digital player or a USB memory stick - to your PEUGEOT Connect Sound (RD5) and heard via the vehicle's speakers.



2

USB memory stick (1.1, 1.2 and 2.0) or Apple® player of generation 5 or later:

- USB memory sticks should be formatted FAT or FAT 32 (NTFS not supported),
- the Apple® player lead is essential,
- navigation through the file database is also possible by means of the steering mounted controls.

3

Other Apple® players of earlier generations and players using the MTP protocol*:

- play via Jack-Jack lead only (not supplied),
- navigation through the file database is from the portable device.

Connecting a USB memory stick

1

Connect the memory stick to the port, directly or using a lead. If the audio equipment is switched on, the USB source is detected as soon as it is connected. Play begins automatically after a delay which depends on the capacity of the USB memory stick.



The file formats supported are .mp3 (mpeg1 layer 3 only) and .wma (standard 9 only, 128 kbits/sec compression).

Certain playlist formats are supported (.m3u, ...).

On reconnection of the previous memory stick used, play is resumed automatically with the last track played.

!

The system puts together playlists (temporary memory) created over a period which depends on the capacity of the USB device. The other sources are available during this time.

The playlists are updated each time the ignition is switched off or each time a USB memory stick is connected.

When connecting for the first time, the classification suggested is by folder. When you reconnect, the classification selected previously is retained.

* According to vehicle.

05 PEUGEOT CONNECT USB

Using the PEUGEOT CONNECT USB

2

Press and hold LIST to display the different classifications.
Select by Folder / Artist / Genre / Playlist, press OK to select the classification required, then press OK again to confirm.



- by Folder: all folders containing audio files recognised on the peripheral device.
- by Artist: all of the artist names defined in the ID3 Tags, classified in alphabetical order.
- by Genre: all of the genres defined in the ID3 Tags.
- by Playlist: in accordance with the playlists recorded on the USB device.

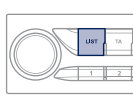

Press LIST briefly to display the previously selected classification.
Navigate through the list using the left/right and up/down buttons.
Confirm the selection by pressing OK.

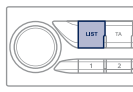

3



Press one of these buttons to gain access to the previous / next track on the classification list currently being played.
Press and hold one of the buttons for fast forward or backward play.

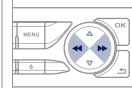

4



Press one of these buttons to gain access to the previous / next Genre, Folder, Artist or Playlist on the classification list currently being played.

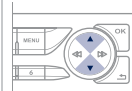

Connecting an Apple® player via the USB port

1

The lists available are Artist, Genre and Playlist (as defined in the Apple® player).
Selection and Navigation are described in steps 1 to 4 above.



Do not connect a hard disk or USB connection device other than audio equipment to the USB port. This could damage your installation.

05 PEUGEOT CONNECT USB

Using the auxiliary input (AUX)

JACK socket or USB port (according to vehicle)



The auxiliary input, JACK or USB, allows the connection of a portable device (MP3 player...).



Do not connect a device to both the JACK socket and the USB port at the same time.

1

Connect the portable device (MP3 player...) to the JACK socket or to the USB port, using a suitable cable (not supplied).



2



Press the SRC button repeatedly to select the AUX source. By default, this source is deactivated.



Adjusting the volume of the auxiliary source

1

First adjust the volume of your portable device.



2



Then adjust the volume of your audio system.

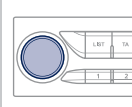

The display and control is via the portable device.



06 BLUETOOTH

Bluetooth telephone

Screen C

(Available according to model and version)

The services offered depend on the network, the SIM card and the compatibility of the Bluetooth equipment used.

Consult your telephone's manual and your operator to find out which services are available to you.

Pairing a telephone / First connection



For safety reasons and because they require prolonged attention on the part of the driver, the operations for pairing of the Bluetooth mobile telephone with the Bluetooth hands-free system of your audio equipment must be carried out with the vehicle stationary and the ignition on.



Go to www.peugeot.co.uk for more information (compatibility, more help, ...).

1

Activate the telephone's Bluetooth function and ensure that it is "visible to all" (telephone configuration).



2



Press the MENU button.

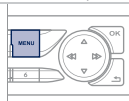

3



In the menu, select:

- Bluetooth telephone function - Audio
- Bluetooth configuration
- Perform a Bluetooth search

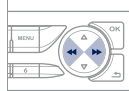

4

A window is displayed with a message that a search is in progress.

5

The first 4 telephones recognised are displayed in this window.



The TELEPHONE menu permits access to the following functions in particular: Directory*, Call list, Pairing management.

* If your telephone is fully compatible.

6

Select the telephone to be connected from the list. Only one telephone can be connected at a time.

7

A virtual keypad is displayed in the screen: enter a code with at least 4 digits. Confirm by pressing OK.



8

A message is displayed in the screen of the telephone chosen. To accept the pairing, enter the same code on the telephone, then confirm with OK.

If pairing fails, the number of attempts is not limited.



9

A message that the pairing has been successful appears in the screen.



The automatic connection authorised is only active after the telephone has been configured.

The directory and the call list can be accessed after the synchronisation period.

06 BLUETOOTH

Receiving a call

- 1 An incoming call is announced by a ring and a superimposed display in the vehicle's screen.

- 2  Select the YES tab on the display using the buttons and confirm by pressing OK.

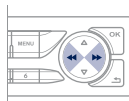

Press this button to accept the call.



Making a call

- 1 From the Bluetooth telephone function Audio menu, select Manage the telephone call then Call, Call list or Directory.

- 2 Press this button for more than two seconds for access to your directory, then navigate with the thumb wheel.
Or
To dial a number, use your telephone's keypad, with the vehicle stationary.

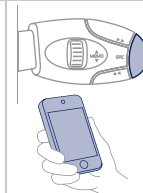

The system accesses the telephone's contacts directory, depending on compatibility, and while the Bluetooth connection with it is maintained.



With certain telephones connected by Bluetooth you can send a contact to the directory of the audio system.
Contacts imported in this way are saved in a permanent directory visible to all, whatever the telephone connected. The menu for the directory is not accessible if it is empty.

06 BLUETOOTH

Ending a call

1

During a call, press this button for more than 2 seconds.
Confirm with OK to end the call.

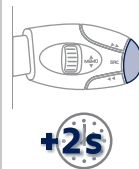

Bluetooth audio streaming*

!

Wireless transmission of the telephone's music files via the audio equipment. The telephone must be able to manage the appropriate Bluetooth profiles (Profiles A2DP / AVRCP).

1

Initiate the pairing between the telephone and the vehicle. This pairing can be initiated from the vehicle's telephone function menu or via the telephone's keypad. Refer to "pairing a telephone" in the previous pages. During the pairing phase, the vehicle must be stationary with the key in the ignition.



2

Select the telephone to be connected from the telephone function menu.
The audio system connects to a newly paired telephone automatically.

3



Activate the streaming source by pressing the SRC button**. The tracks to be played can be controlled as usual via the buttons on the audio system control panel and the steering mounted controls***. The contextual information can be displayed on the screen.



* Depending on the compatibility of the telephone.

** In certain cases, playing of the audio files must be initiated from the keypad.

*** If the telephone supports the function.

07 SCREEN MENU MAP(S)

01:17 20°
27 MAR 2013
12:00

Screen A

MAIN FUNCTION

- 1 Option A
 - 2 Option A1
 - 3 Option A11
- 1 Option B...

RADIO

- 1 RDS options
- 1 Infotext
- 1 Radiotext

DATE AND TIME

MEDIA

- 1 Read mode
 - 2 Normal

- 2 Random
- 2 Random all

LANGUAGES

- 1 Français
 - 2 Italiano
 - 2 Nederlands
 - 2 Português
 - 2 Português-brasil
 - 2 Deutsch
 - 2 English
 - 2 Español

VEHICLE PARAM*

- 1 PARK BRAKE
(Automatic electric parking brake)
- 1 BEND LIGHTING
(Adaptive lighting: directional)
- 1 AUTO HEADLAMPS
(Automatic illumination of headlamps)
- 1 REAR WIPE ACT
(Rear wiper coupled to reverse gear)
- 1 GUIDE LAMPS
(Guide me home lighting)
- 1 ELECTRIC BOOT
(Permanent locking of the boot)
- 1 CABIN SELECT
(Locking of driver's door only: selective unlocking)
- 1 DAY LAMPS

* The settings vary according to vehicle equipment.

07 SCREEN MENU MAP(S)



Screen C

MEDIA

1 Media parameters

2 Choice of playback mode

3 Normal

3 Random

3 Random all

3 Repeat

2 Choice of track listing

3 By folders

3 By artists

3 By genres

3 By playlists

1 Radio parameters

TELEPHONE

1 Call

2 Dial

2 Directory

2 Calls list

2 Voice mail box

1 Directory management

2 Consult an entry

2 Delete an entry

2 Delete all entries

1 Telephone management

2 Telephone status

1 Hang up

BLUETOOTH CONNECTION

1 Connections management

1 Search for a device

07 SCREEN MENU MAP(S)



PERSONALISATION - CONFIGURATION

- 1 Define the vehicle parameters*
- 1 Choice of language
- 1 Display configuration
 - 2 Choice of units
 - 2 Date and time adjustment
 - 2 Display parameters
 - 2 Brightness
- 1 Choice of sounds

* Depending on vehicle equipment.

FREQUENTLY ASKED QUESTIONS

QUESTION	ANSWER	SOLUTION
<p>There is a difference in sound quality between the different audio sources (radio, CD...).</p>	<p>For optimum sound quality, the audio settings (Volume, Bass, Treble, Ambience, Loudness) can be adapted to the different sound sources, which may result in audible differences when changing source (radio, CD...).</p>	<p>Check that the audio settings (Volume, Bass, Treble, Ambience, Loudness) are adapted to the sources listened to. It is advisable to set the AUDIO functions (Bass, Treble, Front-Rear Balance, Left-Right Balance) to the middle position, select the musical ambience "None" and set the loudness correction to the "Active" position in CD mode or to the "Inactive" position in radio mode.</p>
<p>The CD is ejected automatically or is not played by the player.</p>	<p>The CD is inserted upside down, is unplayable, does not contain any audio data or contains an audio format which the player cannot play. The CD is protected by an anti-pirating protection system which is not recognised by the audio equipment.</p>	<ul style="list-style-type: none"> - Check that the CD is inserted in the player the right way up. - Check the condition of the CD: the CD cannot be played if it is too damaged. - Check the content in the case of a recorded CD: consult the advice in the "Audio" section. - The audio equipment's CD player does not play DVDs. - Due to their quality level, certain writeable CDs will not be played by the audio system.
<p>The message "USB peripheral error" is displayed on the screen. The Bluetooth connection is cut.</p>	<p>The battery of the peripheral may not be sufficiently charged.</p> <p>The USB memory stick is not recognised. The memory stick may be corrupt.</p>	<p>Recharge the battery of the peripheral device.</p> <p>Reformat the memory stick.</p>

FREQUENTLY ASKED QUESTIONS

QUESTION	ANSWER	SOLUTION
I am unable to access my voicemail.	Few telephones or service providers allow the use of this function.	
The CD player sound is poor.	The CD used is scratched or of poor quality.	Insert good quality CDs and store them in suitable conditions.
	The audio equipment settings (bass, treble, ambiances) are unsuitable.	Set the treble or bass level to 0, without selecting an ambience.
The stored stations do not function (no sound, 87.5 Mhz is displayed...).	An incorrect waveband is selected.	Press the BAND AST button to return to the waveband (AM, FM1, FM2, FMAST) on which the stations are stored.
The traffic announcement (TA) is displayed. I do not receive any traffic information.	The radio station is not part of the regional traffic information network.	Tune to a radio station which broadcasts traffic information.
The quality of reception of the radio station listened to gradually deteriorates or the stored stations do not function (no sound, 87.5 Mhz is displayed...).	The vehicle is too far from the transmitter used by the station listened to or there is no transmitter in the geographical area through which the vehicle is travelling.	Activate the RDS function to enable the system to check whether there is a more powerful transmitter in the geographical area.
	The environment (hills, buildings, tunnels, basement car parks...) block reception, including in RDS mode.	This phenomenon is normal and does not indicate a failure of the audio equipment.
	The aerial is absent or has been damaged (for example when going through a car wash or into an underground car park).	Have the aerial checked by a PEUGEOT dealer.

FREQUENTLY ASKED QUESTIONS

QUESTION	ANSWER	SOLUTION
Sound cut-outs of 1 to 2 seconds in radio mode.	During this brief sound cut-out, the RDS searches for any frequency permitting better reception of the station.	Deactivate the RDS function if the phenomenon is too frequent and always on the same route.
With the engine off, the audio equipment switches off after a few minutes of use.	When the engine is switched off, the audio equipment operating time depends on the battery charge. The switch-off is normal: the audio equipment switches to economy mode and switches off to prevent discharging of the vehicle's battery.	Start the vehicle's engine to increase the battery charge.
The message "the audio system is overheated" appears on the display.	In order to protect the installation if the surrounding temperature is too high, the audio equipment switches to an automatic thermal protection mode leading to a reduction of the volume or stopping of the playing of the CD.	Switch the audio system off for a few minutes to allow the system to cool.

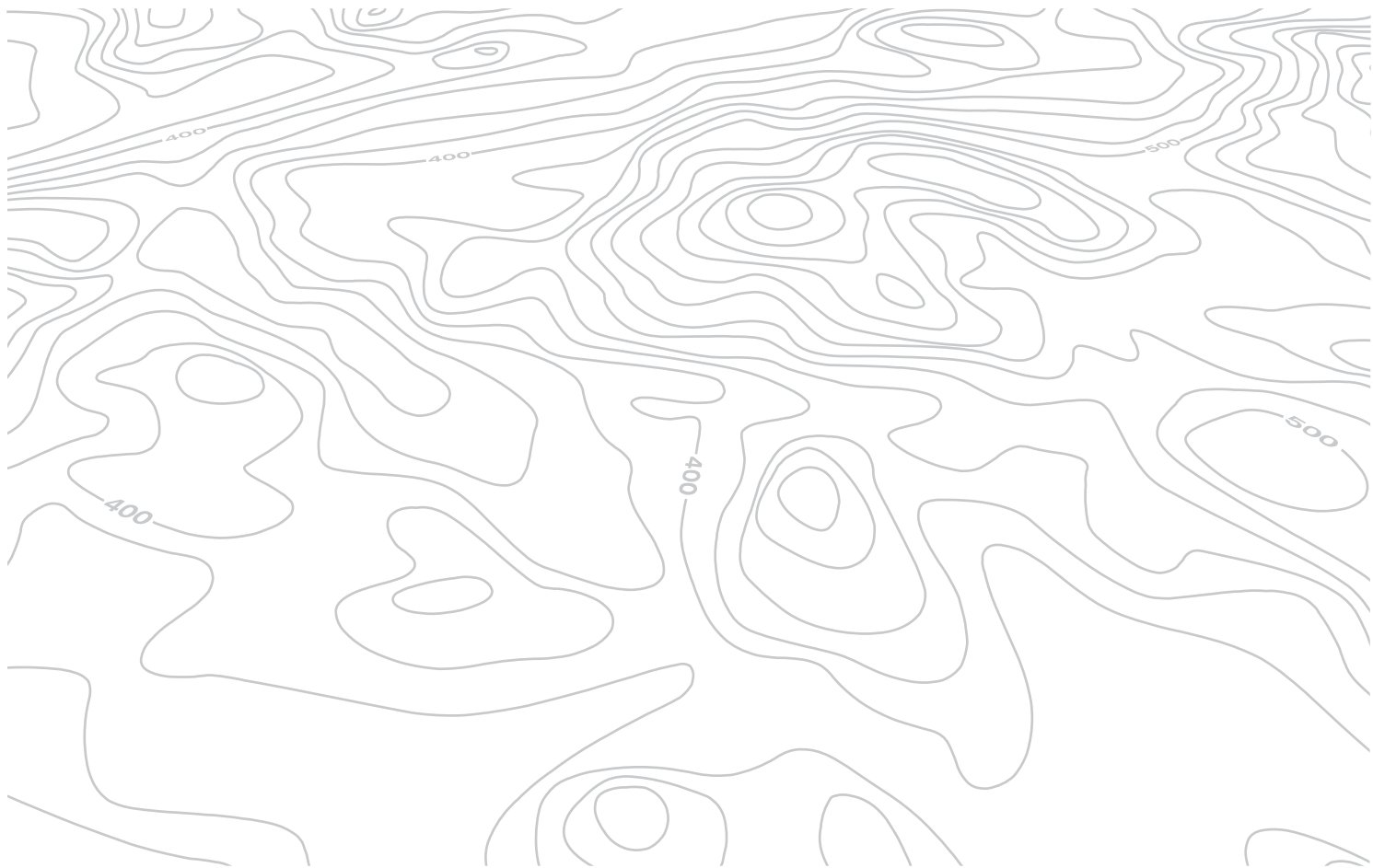

230 V socket84, 88

A

Accessories 263, 264
 Accessory position 110
 Accessory socket, 12V84, 87
 AdBlue® 271
 Additive, AdBlue 25, 271
 Adjusting headlamps 180
 Adjusting head restraints 79
 Adjusting the steering wheel 75
 Airbags 23, 199
 Airbags, curtain 202, 203
 Airbags, front 200, 203
 Airbags, lateral 202, 203
 Air conditioning 10, 97, 99, 101
 Air conditioning, digital 101
 Air conditioning, manual 97, 99
 Air distribution adjustment 98, 100, 103
 Air filter 283
 Air flow 10
 Air flow adjustment 97, 99, 103
 Air intake 105
 Air recirculation 105
 Air vents 95
 Alarm 65
 Anti-theft 50, 112
 Armrest 84, 86, 89
 Armrest, front 86
 Armrest, rear 89
 Assistance call 188, 289, 290
 Audible warning 188
 Audio cable 310, 313, 314, 376
 Audio streaming (Bluetooth) 310, 313, 379
 Automatic braking on risk
 of collision 22, 151, 154

Automatic emergency
 braking 151, 154
 Automatic illumination
 of headlamps 174, 178
 Automatic operation of hazard warning
 lamps 187
 Automatic rain sensitive windscreen
 wipers 181, 183
 Auxiliary sockets 84, 87, 310, 314, 374, 376

B

Battery 251-254, 283
 Battery, charging 254
 Battery, remote control 52, 62, 63
 Bicycle carrier 263
 Blind spot sensors 156
 Blue HDi 271
 Bluetooth (hands-free) 352, 377
 Bluetooth (telephone) 352, 377
 Bonnet 267
 Bonnet stay 267
 Boot 90, 91
 Boot (opening) 54, 58
 Brake discs 284
 Brake lamps 240, 242
 Brake pads 284
 Brakes 24, 284

C

Capacity, fuel tank 72
 CD 310, 370
 CD MP3 310, 371
 Central locking 46-53
 Changing a bulb 235-244

Changing a fuse 245-250
 Changing a wheel 227-233
 Changing a wiper blade 184, 256
 Changing the date 42, 43, 44
 Changing the remote
 control battery 52, 62
 Changing the time 42, 43, 44
 Checking levels 280-282
 Checking the engine oil level 29, 280
 Checking tyre pressures
 (using the kit) 226
 Checks 267-284
 Child lock 220
 Children 198, 200, 204-220
 Child seats 204-206, 210, 211, 219
 Child seats, conventional 210
 Child seats, ISOFIX 213, 215, 216
 Cold climate screen 259
 Collision risk alert 151
 Colour screen 294, 295
 Connectors, audio 87, 310, 314, 374, 376
 Container, AdBlue 276
 Coolant level 26, 281
 Coolant temperature indicator 26
 Courtesy lamps 185
 Cruise control 132, 136, 139
 Cruise control, active 139
 Cup holder 84

D

DAB (Digital Audio
 Broadcasting) 308, 309, 372, 373
 Date (setting) 42, 43, 44
 Daytime running lamps 235, 236, 238, 239
 Deactivating ESP 195
 Deactivating the passenger airbag 200
 Deadlocking 49, 57

Defrosting..... 106, 107
 Demisting 106, 107
 Denon (audio system)..... 291
 Diesel 74
 Diesel additive level 282
 Diesel engine pre-heat warning lamp 15
 Digital Audio Broadcasting
 (DAB) 308, 309, 372, 373
 Dimensions 286
 Dipped beam 173, 235, 237
 Dipstick..... 29, 280
 Direction indicators 187, 235, 238, 240, 242
 Distance alert 147
 Doors backup control 61
 Driving economically 10
 Driving positions (storing)..... 78
 Dynamic emergency braking 118
 Dynamic (sport)..... 128
 Dynamic stability control (DSC)..... 17, 21, 195

E

Eco-driving 10
 Economy mode 255
 Electric window controls 69
 Electronic engine immobiliser..... 50, 63, 112
 Electronic stability control (ESC)..... 193
 Emergency boot release..... 60
 Emergency call 188, 289, 290
 Emergency starting 253
 Emergency warning lamps 94, 187
 Energy economy mode 255
 Engine compartment 268, 269
 Engine compartment fusebox..... 249
 Engine, Diesel 74, 269, 270
 Engine oil level 29, 280
 Engine, petrol 74, 268, 285

Environment..... 10, 52, 62, 96, 254, 282
 ESC/ASR..... 193

F

Filling with fuel 72-74
 Fitting a wheel..... 232
 Fitting roof bars..... 262, 263
 Fittings, boot 90, 91
 Flashing indicators 187, 235, 238, 240, 242
 Foglamps 175
 Foglamps, front 235, 239
 Foglamps, rear 240, 241, 243, 244
 Folding the rear seats 82
 Frequency (radio)..... 305, 369
 Front seats 76-78
 Fuel..... 10, 74
 Fuel consumption..... 10
 Fuel filler cap 72
 Fuel filler flap 72
 Fuel gauge 12, 22, 72
 Fuel tank 12, 22, 72
 Fuses..... 245-250

G

Gearbox,
 automatic... 10, 12, 15, 121, 124, 129, 130, 284
 Gearbox,
 manual 10, 12, 15, 121, 122, 129, 284
 Gear lever, automatic gearbox 124
 Gear lever, manual gearbox 122
 Gear shift indicator 123
 Glove box, cooled 84
 Guidance 320
 Guide-me-home..... 177, 178

H

Halogen headlamps 235, 237
 Hands-free kit 352, 377
 Hazard warning lamps 94, 187
 Headlamp adjustment..... 180
 Headlamp wash 182
 Headlamp wash reservoir..... 282
 Head restraints, front 79
 Head restraints, rear 82, 83
 Heated seats 79
 Heating 97, 99, 101
 Height and reach adjustment,
 steering wheel 75
 High load retaining net..... 396
 Hill start assist..... 121

I

Identification plates..... 287
 Ignition on..... 104, 108, 110
 Indicator lamps, status 13-25
 Indicators, direction 187
 Inflating accessories (using the kit) 226
 Inflating tyres 10, 287
 Inputs for audio
 system..... 84, 87, 310, 314, 374, 376
 Instrument panel 12
 Instrument panel screen 12, 22, 123
 Intelligent Traction Control..... 194
 Interior fittings 84
 Interior mood lighting 186
 ISOFIX 213
 ISOFIX mountings..... 213, 214

J

Jack 227
 Jack cable 314

JACK socket 84, 87, 310, 314, 374, 376
 Jukebox (playing) 315

K

Keeping children
 safe 198, 200, 204-220
 Key 46, 63, 112
 Key, electronic 46, 53-56, 61, 63
 Key in ignition warning 108
 Keyless Entry and
 Starting 55-57, 63, 109, 112
 Key with remote control 46-50, 56, 63, 112

L

Labels, identification 287
 Lamps, warning and indicator 13-25
 LED daytime running lamps 177
 LEDs - light-emitting diodes 235, 240, 242
 Level, AdBlue® additive 271
 Level, brake fluid 281
 Level, headlamp wash 183, 282
 Levels and checks 268, 269, 280-282
 Light-emitting diodes -
 LEDs 235, 236, 238, 240, 242
 Lighting 173
 Lighting bulbs (replacement) 235-244
 Lighting control stalk 173
 Lighting dimmer 31
 Lighting, guide-me home 177, 178
 Lighting, interior 185, 186
 Lighting on reminder 176
 Loading 10, 262
 Load reduction mode 255

Load space cover 92
 Locating your vehicle 50, 54
 Locking the boot 60
 Locking the doors 48, 56
 Long objects, transporting 89
 Lumbar adjustment 76, 80

M

Main beam 173, 235, 237, 239
 Maintenance 10
 Map reading lamps 185
 Markings, identification 287
 Massage function 80
 Mat 85
 Memorising a speed 132
 Menu 298, 300, 302, 316,
 318, 320, 336, 348, 350
 Menu, main 368
 Menus (Touch screen) 294
 Mini fuel level 22, 72
 Mirror, rear view 172
 Mirrors, door 156, 170
 Mountings for ISOFIX seats 213, 214
 MP3 CD 310, 371

N

Number plate lamps 244

O

Oil filter 283
 Oil level 29, 280
 Opening the bonnet 267
 Opening the boot 46, 53-55, 58
 Opening the doors 46, 47, 53, 55
 Operation indicator lamps 13-25

P

Paint colour code 287
 Panoramic glass sunroof 71
 Park Assist 162
 Parking brake, electric 20, 114, 119, 284
 Parking brake, manual 15, 113, 284
 Parking sensors, front 160
 Parking sensors, rear 159
 Particle emission filter 281-283
 Passenger compartment filter 283
 PEUGEOT CONNECT APPS 347
 PEUGEOT Connect Assistance 290
 PEUGEOT Connect SOS 290
 PEUGEOT Connect Sound
 (RD5) 365
 Player, CD MP3 310, 371
 Port, USB 84, 87, 310, 314, 374, 376
 Priming the fuel system 270
 Protecting children 198, 200, 204-220
 Puncture 221

R

Radio 304, 369
 RDS 307, 369
 Rear foglamp 240, 241, 243, 244
 Rear screen (demisting) 107

Recharging the battery254
 Reduction of electrical load255
 Refilling AdBlue276
 Regeneration of the particle emissions filter283
 Reinitialising the remote control52, 62
 Remote control46-48, 53-57, 63
 Removable screen (snow shield)259, 260
 Removing a wheel230
 Removing the mat85
 Repair kit, puncture221
 Replacing bulbs235-244
 Replacing fuses245-250
 Replacing the air filter283
 Replacing the oil filter283
 Replacing the passenger compartment filter283
 Replacing wiper blades184, 256
 Resetting the service indicator28
 Resetting the trip recorder30
 Reversing camera161
 Reversing lamp240, 242
 Risk areas (update)325
 Roof bars262, 263
 Roof blind71
 Routine checks283, 284
 Running out of fuel (Diesel)270

S

Safety for children198, 200, 204-220
 Screen, instrument panel12, 32, 123
 Screen menu map298, 300, 302, 316, 318, 320, 336, 348, 350, 380-382
 Screen, monochrome380
 Screen, multifunction (with audio equipment)44, 368

Screen, multifunction (without audio equipment)45
 Screenwash182
 Screenwash fluid level183, 282
 Screenwash reservoir282
 SCR (Selective Catalytic Reduction)271
 Seat adjustment76, 77
 Seat belts196-198, 210
 Seats, electric77
 Seats, rear81, 82
 Serial number, vehicle287
 Service indicator27
 Servicing10
 Setting the clock42, 43, 44
 Sidelamps173, 235, 236, 238-240, 242
 Side repeater239
 Ski flap89
 Snow chains234
 Spare wheel227, 228
 Speed limiter132, 133
 Spotlamps, side179, 239
 Starting the engine108, 109, 124
 Starting using another battery253
 Steering mounted controls, audio297, 367
 Stop & Start24, 35, 72, 106, 129, 130, 251, 267, 283
 Storage84, 86, 89-91
 Storage wells90, 91
 Storing driving positions78
 Stowing rings90, 91
 Switching off the engine108, 109, 111
 Synchronising the remote control52, 62
 Synthesiser, voice335
 System settings344

T

Tables of fuses245-250
 Tank, AdBlue® additive271, 276
 Tank, fuel22, 72
 Technical data285
 Telephone352, 371
 Temperature adjustment97, 99, 101
 Temperature control for heated seats79
 Temperature, coolant26
 Temporary puncture repair kit221
 Three flashes function (direction indicators)187
 TMC (Traffic info)330
 Tools221, 227
 Total distance recorder30
 Touch screen34, 36, 38, 40, 42, 132, 191, 293, 295
 Touch screen (Menus)37, 294
 Towbar260
 Towed loads285
 Towing the vehicle257
 Traction control (ASR)17, 21
 Traffic information (TA)331, 370
 Traffic information (TMC)330
 Trailer260
 Trip computer32-35
 Trip distance recorder30
 Tyre pressures11, 233, 287
 Tyres287
 Tyre under-inflation detection24, 189

U

Under-inflation (detection)189
 Unlocking46-61
 Unlocking the boot54, 58
 Update risk areas325
 Updating the date42, 43, 44

Updating the time.....	42, 43, 44
UREA	271
USB	310
USB (PEUGEOT Connect)	87, 310, 374

V

Vehicle identification.....	287
Ventilation	95-97, 99, 104

W

Warning lamps	13-25
Warning triangle.....	94
Wash-wipe, rear.....	182
Weights	285
Welcome lighting.....	179
Window controls	69
Wiper control stalk	181-183
Wiper, rear.....	182
Wipers	16, 181-184









High load retaining net (SW)

This allows the use of the entire loading volume up to the roof:

- behind the front seats (row 1) when the rear seats are folded.
- behind the rear seats (row 2).



Row 1

- ☞ Fold the rear seats.
- ☞ Remove the cover trims in the roof on each side.
- ☞ Position the net's upper hooks in the roof, on each side in turn.
- ☞ Attach the bottom of the net to the fixings located at the seat belt mountings.
- ☞ Pull on the straps to stretch the net.

Once fitted, the net does not prevent folding of the rear seat backrests.

Row 2

- ☞ Remove the cover trims in the roof on each side.
- ☞ Position the net's upper hooks in the roof, on each side in turn.
- ☞ Attach the bottom of the net to the rings located either side of the boot carpet or on the boot rails (depending on trim level).
- ☞ Pull on the straps to stretch the net.

This handbook describes all of the equipment available in the whole range.

Your vehicle will be fitted with some of this equipment described in this document, depending on its trim level, version and the specification for the country in which it is sold.

The descriptions and illustrations are given without any obligation. Automobiles PEUGEOT reserves the right to modify the technical specifications, equipment and accessories without having to update the current handbook.

This document is an integral part of your vehicle. It should be passed on to the new user in the event of sale or transfer.

Automobiles PEUGEOT declares, by application of the provisions of the European regulation (Directive 2000/53) relating to End of Life Vehicles, that it achieves the objectives set by this regulation and that recycled materials are used in the manufacture of the products that it sells.

Reproduction or translation of all or part of this handbook is prohibited without written authorisation from Automobiles PEUGEOT.

For any work on your vehicle, use a qualified workshop that has the technical information, competence and equipment required, which a PEUGEOT dealer is able to provide.

Anglais

Printed in the EU



PEUGEOT

Automobiles PEUGEOT - Siège Social : 75, avenue de la Grande-Armée 75016 PARIS

Tél. 33 (0)1 40 66 55 11 - Fax 33 (0)1 40 66 54 14

Adresse postale : Automobiles PEUGEOT B.P. 01 75761 PARIS cedex 16 - Adresse Internet : <http://www.peugeot.com>

Société Anonyme au capital de 172 771 770 Euros - R.C.S. PARIS B 552 144 503. SIRET 552 144 503 00018. APE 341 Z

01-14

